

CHAPTER E

AT-GRADE

INTERSECTIONS

**CHAPTER E
AT-GRADE INTERSECTIONS**

E.1	INTRODUCTION	E1-1
E.1.1	DEFINITION AND GENERAL DESCRIPTION	E1-1
E.1.2	COMPARISON OF AT-GRADE INTERSECTIONS WITH INTERCHANGES	E1-1
E.1.3	DESIGN OBJECTIVES	E1-1
E.1.4	DESIGN CONSIDERATIONS	E1-1
E.2	DESIGN PRINCIPLES	E2-1
E.2.1	ELEMENTS AFFECTING DESIGN	E2-1
E.2.1.1	Traffic Factors	E2-1
E.2.1.2	Physical Factors	E2-1
E.2.1.3	Economic Factors	E2-1
E.2.1.4	Human Factors	E2-1
E.2.2	TYPES OF MANOEUVRES	E2-2
E.2.3	BASIC INTERSECTION FORMS	E2-2
E.2.4	CONFLICT AREAS AT INTERSECTIONS	E2-2
E.2.5	ANGLE OF INTERSECTION	E2-5
E.2.6	SIMPLE INTERSECTION DESIGN	E2-9
E.2.6.1	Simple Open Throat	E2-9
E.2.6.2	Open Throat with Auxiliary Lanes	E2-10
E.2.7	CHANNELIZATION DESIGN	E2-10
E.2.7.1	Criteria and Functions of Channelization	E2-10
E.2.7.2	Principles of Channelization Design	E2-17
E.2.7.2.1	Merging Conditions with and without Speed Change Lanes	E2-17
E.2.7.3	Islands	E2-17
E.3	SIGHT DISTANCE AT INTERSECTIONS	E3-1
E.3.1	MINIMUM SIGHT TRIANGLE	E3-1
E.3.1.1	Approaches	E3-1
E.3.1.2	Departures	E3-1
E.3.2	INTERSECTION TRAFFIC CONTROLS	E3-1
E.3.2.1	No Control	E3-1
E.3.2.2	Yield Control	E3-4
E.3.2.3	Stop Control	E3-4
E.3.2.3.1	Crossing Movement	E3-5
E.3.2.3.2	Turning Movements	E3-5
E.3.2.4	Signal Control	E3-8
E.3.2.5	Summary of Design Requirements for Sight Distance at Intersections	E3-11
E.3.4	DECISION SIGHT DISTANCE	E3-11

**CHAPTER E
AT-GRADE INTERSECTIONS**

E.3.5	SIGHT DISTANCE AT A STRUCTURE	E3-11
E.3.5.1	Sight Distance for Minor Side Road and Highway Entrance	E3-11
E.3.5.2	Sight Distance at Interchange Ramp Terminals	E3-11
E.3.6	SIGHT DISTANCE AT RAILWAY CROSSINGS	E3-14
E.4	INTERSECTION GEOMETRIC CONTROLS	E4-1
E.4.1	HORIZONTAL ALIGNMENT	E4-1
E.4.2	VERTICAL ALIGNMENT	E4-6
E.4.3	PAVEMENT CROSS-SECTIONS AT INTERSECTIONS	E4-6
E.4.4	SHOULDERS AT OPEN THROAT INTERSECTIONS.	E4-13
E.4.4.1	General.	E4-13
E.4.4.2	Shoulder Treatment at Open Throat Intersections	E4-13
E.5	DESIGN VEHICLES	E5-1
E.5.1	DESIGN VEHICLE CLASSES.	E5-1
E.5.2	DESIGN VEHICLES TYPES AND THEIR DIMENSIONS	E5-1
E.5.3	DESIGN VEHICLE SELECTION FOR INTERSECTION DESIGN GEOMETRICS	E5-2
E.5.4	DESIGN VEHICLES' TURNING PATHS AND TEMPLATES; MINIMUM TURNING RADII	E5-5
E.5.4.1	Low-Speed Offtracking	E5-6
E.5.4.2	High-Speed Offtracking	E5-6
E.5.4.3	Minimum Turning Paths of Design Vehicles	E5-6
E.5.5	APPLICATION OF DESIGN VEHICLE TURNING TEMPLATES	E5-11
E.5.6	WIDENING OF THE SIDE ROAD AT INTERSECTIONS	E5-13
E.5.7	SPECIAL DESIGN CONSIDERATIONS; FARM EQUIPMENT	E5-15
E.6	SIMPLE OPEN THROAT INTERSECTIONS	E6-1
E.6.1	MINIMUM DESIGNS; MINIMUM RADII CURVES	E6-1
E.6.2	SELECTION OF CIRCULAR AND TWO-CENTRED COMPOUND CIRCULAR CURVES	E6-1
E.6.3	APPLICATION OF CIRCULAR AND TWO-CENTRED COMPOUND CIRCULAR CURVES; MINIMUM RADII CURVES.	E6-1
E.7	OPEN THROAT WITH AUXILIARY LANES	E7-1
E.7.1	RIGHT TURN TAPER	E7-1
E.7.2	RIGHT TURN TAPER WITH PARALLEL LANE	E7-2
E.8	RIGHT TURN LANES AT CHANNELIZED INTERSECTIONS	E8-1
E.8.1	DECELERATION TAPER	E8-1
E.8.2	PARALLEL DECELERATION LANE WITH TAPER.	E8-2
E.8.3	ACCELERATION TAPER.	E8-3
E.8.4	PARALLEL ACCELERATION LANE WITH TAPER.	E8-4
E.8.5	EFFECT OF GRADE	E8-6
E.8.6	YIELD TAPER AT SIDE ROAD.	E8-8
E.8.7	RAMP DESIGN FOR CHANNELIZED INTERSECTIONS	E8-9
E.8.8	CIRCULAR CURVES	E8-9

**CHAPTER E
AT-GRADE INTERSECTIONS**

E.8.9	SPIRALLED CIRCULAR CURVES	E8-11
E.8.10	APPROACH-END BULLNOSE AT EXIT TERMINALS	E8-12
E.8.11	WIDTH OF PAVEMENT FOR RAMP DESIGN	E8-13
E.8.12	MERGE-END BULLNOSE AT ENTRANCE TERMINALS	E8-16
E.8.13	BULLNOSE SIZE	E8-16
E.8.14	DIRECTIONAL ISLANDS	E8-16
E.8.14.1	Island Shape	E8-17
E.8.14.2	Island Size	E8-17
E.8.15	CHANNELIZATION DESIGN; SUMMARY	E8-18
E.9	LEFT TURN LANES; UNSIGNALIZED INTERSECTIONS	E9-1
E.9.1	LEFT TURN LANE FOR TWO-LANE HIGHWAYS	E9-4
E.9.1.1	Left Turn Lane in One Direction	E9-4
E.9.1.2	Left Turn Slip Around Treatment at 'T' Intersections	E9-7
E.9.1.3	Left Turn Lanes in Two Directions	E9-8
E.9.2	LEFT TURN LANE DESIGN ON SIDE ROAD	E9-10
E.9.3	LEFT TURN LANES FOR FOUR-LANE UNDIVIDED HIGHWAYS	E9-11
E.9.4	LEFT TURN LANES FOR FOUR-LANE DIVIDED HIGHWAYS	E9-11
E.9.5	LEFT TURN LANE DESIGN ON CURVED ALIGNMENT	E9-13
E.10	LEFT TURN LANES; SIGNALIZED INTERSECTIONS	E10-1
E.10.1	DIVISIONAL ISLANDS	E10-1
E.10.2	LEFT TURN LANES FOR FOUR-LANE UNDIVIDED HIGHWAYS	E10-4
E.10.2.1	Left Turn Lane in One Direction	E10-4
E.10.2.2	Left Turn Lanes in Two Directions	E10-4
E.10.2.3	Widening Through a Signalized Intersection	E10-5
E.10.2.4	Double Left Turn Lanes	E10-7
E.10.3	MEDIAN OPENING DESIGN AND LEFT TURN LANES FOR DIVIDED HIGHWAYS; SIGNALIZED AND UNSIGNALIZED INTERSECTIONS	E10-10
E.11	TRANSITION BETWEEN FOUR-LANE HIGHWAY AND TWO-LANE HIGHWAY AT INTERSECTIONS	E11-1
E.11.1	UNDIVIDED HIGHWAYS	E11-1
E.11.2	DIVIDED HIGHWAYS	E11-1
E.12	RAILWAY CROSSINGS AT GRADE	E12-1
E.12.1	RESTRICTIONS	E12-1
E.12.2	VERTICAL ALIGNMENT	E12-1
E.12.3	HORIZONTAL ALIGNMENT	E12-1
E.12.4	WIDTH OF CROSSING	E12-1
E.12.5	VISIBILITY	E12-2
E.12.6	PROTECTION AT CROSSINGS	E12-2

**CHAPTER E
AT-GRADE INTERSECTIONS**

APPENDIX

E.A.1	LEFT TURN LANE WARRANTS AND STORAGE LANE LENGTHS FOR TWO-LANE HIGHWAYS; UNSIGNALIZED INTERSECTIONS	EA-1
E.B.1	LEFT TURN LANE WARRANTS AND STORAGE LANE LENGTHS FOR FOUR-LANE UNDIVIDED HIGHWAYS; UNSIGNALIZED INTERSECTIONS	EB-1
E.C.1	LEFT TURN LANE WARRANTS AND STORAGE LANE LENGTHS FOR FOUR-LANE DIVIDED HIGHWAYS; UNSIGNALIZED INTERSECTIONS	EC-1
EA-1	Design Hour Volume (DHV) Turning Volume Diagram	EA-1
EA-2	Left Turn Storage Lanes, Two-Lane Highways, Unsignalized; Design Speed 50 km/h; 5% and 10% Left Turns	EA-3
EA-3	Left Turn Storage Lanes, Two-Lane Highways, Unsignalized; Design Speed 50 km/h; 15% and 20% Left Turns	EA-4
EA-4	Left Turn Storage Lanes, Two-Lane Highways, Unsignalized; Design Speed 50 km/h; 25% and 30% Left Turns	EA-5
EA-5	Left Turn Storage Lanes, Two-Lane Highways, Unsignalized; Design Speed 50 km/h; 35% and 40% Left Turns	EA-6
EA-6	Left Turn Storage Lanes, Two-Lane Highways, Unsignalized; Design Speed 60 km/h; 5% and 10% Left Turns	EA-7
EA-7	Left Turn Storage Lanes, Two-Lane Highways, Unsignalized; Design Speed 60 km/h; 15% and 20% Left Turns	EA-8
EA-8	Left Turn Storage Lanes, Two-Lane Highways, Unsignalized; Design Speed 60 km/h; 25% and 30% Left Turns	EA-9
EA-9	Left Turn Storage Lanes, Two-Lane Highways, Unsignalized; Design Speed 60 km/h; 35% and 40% Left Turns	EA-10
EA-10	Left Turn Storage Lanes, Two-Lane Highways, Unsignalized; Design Speed 70 km/h; 5% and 10% Left Turns	EA-11
EA-11	Left Turn Storage Lanes, Two-Lane Highways, Unsignalized; Design Speed 70 km/h; 15% and 20% Left Turns	EA-12
EA-12	Left Turn Storage Lanes, Two-Lane Highways, Unsignalized; Design Speed 70 km/h; 25% and 30% Left Turn	EA-13
EA-13	Left Turn Storage Lanes, Two-Lane Highways, Unsignalized; Design Speed 70 km/h; 35% and 40% Left Turns	EA-14
EA-14	Left Turn Storage Lanes, Two-Lane Highways, Unsignalized; Design Speed 80 km/h; 5% and 10% Left Turns	EA-15

**CHAPTER E
AT-GRADE INTERSECTIONS**

APPENDIX

EA-15	Left Turn Storage Lanes, Two-Lane Highways, Unsignalized; Design Speed 80 km/h; 15% and 20% Left Turns	EA-16
EA-16	Left Turn Storage Lanes, Two-Lane Highways, Unsignalized; Design Speed 80 km/h; 25% and 30% Left Turns	EA-17
EA-17	Left Turn Storage Lanes, Two-Lane Highways, Unsignalized; Design Speed 80 km/h; 35% and 40% Left Turns	Ea-18
EA-18	Left Turn Storage Lanes, Two-Lane Highways, Unsignalized; Design Speed 90 km/h; 5% and 10% Left Turns	EA-19
EA-19	Left Turn Storage Lanes, Two-Lane Highways, Unsignalized; Design Speed 90 km/h; 15% and 20% Left Turns	EA-20
EA-20	Left Turn Storage Lanes, Two-Lane Highways, Unsignalized; Design Speed 90 km/h; 25% and 30% Left Turns	EA-21
EA-21	Left Turn Storage Lanes, Two-Lane Highways, Unsignalized; Design Speed 90 km/h; 35% and 40% Left Turn	EA-22
EA-22	Left Turn Storage Lanes, Two-Lane Highways, Unsignalized; Design Speed 100 km/h; 5% and 10% Left Turns	EA-23
EA-23	Left Turn Storage Lanes, Two-Lane Highways, Unsignalized; Design Speed 100 km/h; 15% and 20% Left Turns	EA-24
EA-24	Left Turn Storage Lanes, Two-Lane Highways, Unsignalized; Design Speed 100 km/h; 25% and 30% Left Turns	EA-25
EA-25	Left Turn Storage Lanes, Two-Lane Highways, Unsignalized; Design Speed 100 km/h; 35% and 40% Left Turns	EA-26
EA-26	Left Turn Storage Lanes, Two-Lane Highways, Unsignalized; Design Speed 110 km/h; 5% and 10% Left Turns	Ea-27
EA-27	Left Turn Storage Lanes, Two-Lane Highways, Unsignalized; Design Speed 110 km/h; 15% and 20% Left Turns	EA-28
EA-28	Left Turn Storage Lanes, Two-Lane Highways, Unsignalized; Design Speed 110 km/h; 25% and 30% Left Turns	EA-29
EA-29	Left Turn Storage Lanes, Two-Lane Highways, Unsignalized; Design Speed 110 km/h; 35% and 40% Left Turns	EA-30
EB-1	Left Turn Storage Lanes, Four-Lane Undivided Highways, Unsignalized.	EB-2
EC-1	Left Turn Storage Lanes, Four-Lane Divided Highways, Unsignalized	EC-2

**CHAPTER E
AT-GRADE INTERSECTIONS**

LIST OF TABLES

E3-1	Minimum Stopping Sight DistanceE3-4
E3-2	Minimum Distance Travelled in 3s.E3-4
E3-3	Minimum Property Requirements at 90° Intersections for Approaches with Stop ControlE3-7
E3-4	Minimum Distance to Signal HeadsE3-8
E3-5	Sight Distance Requirements for Railway Crossings	E3-15
E5-1	Design Vehicle DimensionsE5-4
E5-2	Minimum Turning Radii of Design VehiclesE5-4
E5-3	Design Vehicle and Turning ConditionE5-6
E6-1	Minimum Circular Curves at Simple Open Throat Intersections for Urban and Rural AreasE6-2
E6-2	Minimum Two-Centred Compound Circular Curves at Simple Open Throat Intersections for Urban and Rural Areas CurvesE6-4
E6-3	Two-Centred Compound Curves for Design Vehicle WB-15 Stop Condition from Side Road to Main Highway on Tangent AlignmentE6-5
E6-4	Two-Centred Compound Curves for Design Vehicle WB-15 Yield Condition; Tangent AlignmentE6-6
E6-5	Two-Centred Compound Curves for Design Vehicle WB-17.5 Stop Condition from Side Road to Main Highway on Tangent AlignmentE6-7
E6-6	Two-Centred Compound Curves for Design Vehicle WB-17.5 Yield Condition; Tangent AlignmentE6-8
E7-1	Right Turn Taper with Parallel Deceleration Lane Lengths, Flat Grades 2% or LessE7-2
E7-2	Grade Factors for Deceleration LengthE7-3
E8-1	Total Deceleration Lane Lengths, Flat Grades 2% or LessE8-2
E8-2	Taper Length for Parallel Lane DesignE8-2
E8-3	Total Acceleration Lane Lengths, Flat Grades 2% or Less; Highway Volume <400 VPH/LaneE8-4
E8-4	Total Acceleration Lane Lengths, Flat Grades 2% or Less; Highway Volume >400 VPH/LaneE8-5
E8-5	Grade Factors for Deceleration and Acceleration LanesE8-7

**CHAPTER E
AT-GRADE INTERSECTIONS**

LIST OF TABLES

E8-6	Recommended Curve Radii, Spiral Parameters and Superelevation for Channelization Ramp Design	E8-9
E8-7	Bullnose Offsets	E8-12
E8-8	Design Widths of Pavement for Ramp Design	E8-14
E9-1	Deceleration Lengths for Left Turn Lanes; For 2-Lane and 4-Lane Highways; Flat Grade 2% or Less	E9-2
E9-2	Grade Factors for Deceleration Length	E9-2
E9-3	Additional Storage Lane Length for WB-15 Trucks	E9-3
E10-1	Deceleration Lengths for Left Turn Lanes at Median Opening Design	E10-10
E11-1	Parallel Lane and Taper Lengths for Transition between Four-Lane Highway and Two-Lane Highway	E11-1

**CHAPTER E
AT-GRADE INTERSECTIONS**

LIST OF FIGURES

E2-1	Types of Manoeuvres	E2-3
E2-2	Basic Intersection Forms	E2-4
E2-3	Conflict Areas at Intersections.	E2-5
E2-4	Conflict Points at Intersections	E2-6
E2-5	Intersections with Reduced Conflict Areas.	E2-7
E2-6	Angle of Intersection	E2-8
E2-7	Simple Open Throat Intersections.	E2-9
E2-8	Open Throat Intersections with Auxiliary Lanes for 'T' Intersections	E2-11
E2-9	Open Throat Intersection with Auxiliary Lanes for Cross Intersections.	E2-12
E2-10	Separation of Conflicts	E2-13
E2-11	Merging at a Flat Angle	E2-13
E2-12	Control of Paved Areas by Use of Islands	E2-14
E2-13	Speed Control	E2-14
E2-14	Refuge for Turning Vehicles and Pedestrians	E2-15
E2-15	Control of Prohibited Turns	E2-15
E2-16	Segregation of Traffic Movements.	E2-16
E2-17	Islands for Location of Traffic Poles	E2-16
E2-18	Merging Conditions with and without Speed Change Lane	E2-18
E2-19	Directional Islands	E2-20
E2-20	Divisional Islands	E2-21
E2-21	Refuge Islands.	E2-21
E3-1	Sight Distance at Intersections for Approaches	E3-2
E3-2	Sight Distance at Intersections for Departures.	E3-3
E3-3	Sight Distance and Visibility Triangle at 90° Intersections for Approaches with Stop Control	E3-6
E3-4	Stop Control on Side Road - Acceleration from Stop	E3-8
E3-5	Sight Distance Requirements for Crossing Movements from Stop Condition	E3-9
E3-6	Sight Distance Requirements for Stopping, Crossing and Turning Movements.	E3-10
E3-7	Design Requirements for Sight Distances at Intersections.	E3-12

**CHAPTER E
AT-GRADE INTERSECTIONS**

LIST OF FIGURES

E3-8	Decision Sight Distance for Critical Locations	E3-13
E3-9	Sight Distance at a Structure	E3-13
E3-10	Sight Distance at Railway Crossings	E3-15
E4-1	Desirable Horizontal Alignment	E4-2
E4-2	Re-Alignment of Side Road at Skewed 'T' Intersection	E4-3
E4-3	Re-Alignment of Skewed Cross-Intersection, Point of Intersection Retained	E4-4
E4-4	Re-Alignment of Skewed Cross-Intersection, Point of Intersection Relocated	E4-5
E4-5	Side Road Approach Grade	E4-6
E4-6	Pavement Cross Sections Typical Side Road Profile Adjustment	E4-8
E4-7	Pavement Cross Sections Adjustment of Cross Slope	E4-9
E4-8	Pavement Cross Sections No Adjustment on Side Road Profile.	E4-10
E4-9	Pavement Cross Sections Adjustment on Side Road Profile.	E4-10
E4-10	Pavement Cross Sections Typical Adjustment of Profile and Cross Slope at Two Main Highways	E4-11
E4-11	Pavement Cross Sections Side Road Profile Adjustment	E4-12
E4-12	Shoulder Transition at Open Throat Intersections with Auxiliary Lanes	E4-14
E4-13	Gravel Shoulder Treatment at Simple Open Throat Intersections	E4-14
E4-14	Paved Shoulder Treatment at Intersections	E4-15
E4-15	Shoulder Treatment with Concrete Curb and Gutter at Intersections	E4-15
E4-16	Guidelines for Shoulder Treatment at Open Throat Intersections	E4-16
E5-1	Design Vehicle Types	E5-3
E5-2	Turning Path of Design Vehicle	E5-5
E5-3	Truck Turning Templates, Minimum Turning Path for SU Design Vehicle	E5-7
E5-4	Truck Turning Templates, Minimum Turning Path for WB-15 Design Vehicle	E5-8
E5-5	Truck Turning Template, Minimum Turning Path for WB-17.5 Design Vehicle.	E5-9
E5-6	Truck Turning Templates, Minimum Turning Path for WB-20.5 Design Vehicle	E5-10
E5-7	Application of Design Vehicle Turning Templates.	E5-11

**CHAPTER E
AT-GRADE INTERSECTIONS**

E5-8	Application of Design Vehicle Turning Templates	E5-12
E5-9	Application of Design Vehicle Turning Templates	E5-12
E5-10	Widening of Side Road at `T' Intersections	E5-13
E5-11	Widening of Side Road at `T' Intersections	E5-14
E5-12	Widening of Side Road at `T' Intersections	E5-14
E5-13	Widening of Side Road at `Cross' Intersections	E5-15
E6-1	Edge of Pavement Design at Simple Open Throat Intersections for P, SU & B-12 Design Vehicles	E6-2
E6-2	Edge of Pavement Design at Simple Open Throat Intersections for Tractor-Semitrailer Combinations	E6-3
E7-1	Right Turn Taper Lane Design at `T' Intersections	E7-1
E7-2	Right Turn Taper Lane Design at `Cross' Intersections	E7-1
E7-3	Right Turn Taper with Parallel Deceleration Lane Design	E7-2
E8-1	Deceleration Taper at Channelized Intersections	E8-1
E8-2	Parallel Deceleration Lane with Taper at Channelized Intersections	E8-3
E8-3	Acceleration Taper at Channelized Intersections	E8-3
E8-4	Parallel Acceleration Lane with Taper at Channelized Intersections	E8-5
E8-5	Yield Taper at Channelized Intersections, Main Highway to Side Road	E8-8
E8-6	Ramp Design without Spirals, Side Road to Main Highway	E8-10
E8-7	Ramp Design with Spirals, Main Highway to Side Road	E8-11
E8-8	Approach-End Design	E8-12
E8-9	Ramp Design with Spirals and Pavement Widening, Side Road to Main Highway	E8-15
E8-10	Merge-End Design	E8-16
E8-11	Separate Right Turn Design with Directional Island	E8-17
E8-12	Design of Bullnose Location on Side Road; Preferred Design	E8-19
E8-13	Design of Bullnose Location on Side Road; Restricted Property	E8-19
E8-14	Fully Channelized Intersection	E8-20

**CHAPTER E
AT-GRADE INTERSECTIONS**

list of figures

E9-1	Left Turn Lane, Pictorial Description of TermsE9-1
E9-2	Left Turn Lanes at `T' IntersectionsE9-5
E9-3	Left Turn Lane at Cross IntersectionE9-6
E9-4	Left Turn Slip Around Design, Tangent AlignmentE9-7
E9-5	Left Turn Lane Design, 2-Lane HighwayE9-9
E9-6	Left Turn Lane Design on Side Road	E9-10
E9-7	Left Turn Lane Design, 4-Lane Undivided, `T' Intersection	E9-12
E9-8	Opposing Left Turn Lane, 4-Lane Undivided, Cross Intersection	E9-12
E9-9	Left Turn Lane Design, Alignment Improvement to Eliminate Deflections	E9-14
E9-10	Left Turn Lane Design, Alignment Improvement to Eliminate Deflections	E9-15
E9-11	Left Turn Lane Design, Alignment Improvement to Eliminate Deflections	E9-16
E9-12	Left Turn Lane Design, Alignment Improvement to Eliminate Deflections	E9-17
E10-1	Opposing Divisional Islands	E10-3
E10-2	Offset Divisional Islands	E10-3
E10-3	Opposing Divisional Islands at `T' Intersections.	E10-5
E10-4	Offset Divisional Islands at `Cross' Intersections	E10-5
E10-5	Widening through a Signalized Intersection	E10-6
E10-6	Exclusive Double Left Turn Lanes; Both Lanes Protected	E10-7
E10-7	Double Left Turn Lanes; One Lane Protected	E10-8
E10-8	Double Left Turn Lanes; One Lane Optional	E10-8
E10-9	Turning Paths for Double Left Turns	E10-9
E10-10	Design of Median Opening - Narrow Median, Bullet-Nose Design	E10-11
E10-11	Design of Median Opening - Wide Median, Flat-Nose Design	E10-11
E11-1	Transition between Four-Lane Highway and Two-Lane Highway at Intersection	E11-1
E11-2	Transition between Four-Lane and Two-Lane Highway, Merge on Curved Alignment	E11-2
E11-3	Transition between Four-Lane and Two-Lane Highway, Merge on Tangent Alignment	E11-3

E.1 INTRODUCTION

E.1.1 DEFINITION AND GENERAL DESCRIPTION

An intersection is defined as the general area where two or more roadways join or cross. It is an integral and important part of the highway system since much of the efficiency, safety, speed, cost of operation and maintenance, as well as capacity depend upon its design.

E.1.2 COMPARISON OF AT-GRADE INTERSECTIONS WITH INTERCHANGES

Intersections at-grade differ from interchanges in several aspects; the most significant differences are the grade separation and the traffic volume that can pass through each of these intersection forms. Other differing aspects include costs of construction and maintenance, safety, complexities of design features, signing and traffic signals.

A well designed at-grade intersection can handle traffic efficiently and safely until volumes are such, that delays and congestion develop at which point a grade separation or an interchange should be introduced.

E.1.3 DESIGN OBJECTIVES

The incidence of possible conflicts at intersections are very high, therefore, they are considered to be areas of high accident potential. The designer must strive to minimize these conflict points in his design, while providing adequately for the through, crossing and turning movements.

In the design of intersections careful consideration should be given to the appearance of the intersection as the driver will see it. Upon approaching an intersection a reverse curve may appear compressed and confusing to the driver. To avoid abrupt changes in alignment, sufficient transitions or compound curves should be provided to allow the driver to comfortably negotiate them, and to ensure a pleasing appearance.

An understanding of driving habits and application of human factors is indispensable in the development of appropriate geometric design and the subsequent operational quality of the intersection. Operational safety and efficiency of an intersection depends highly on the design suitability. The driver's performance is improved when they use a highway facility designed to be within their capabilities and limitations.

When a design is incompatible with the attributes of drivers, the chances for driver error increases. Inefficient operation and accidents are often a result.

In this manual, minimum and standard geometric features and designs are developed from considerations which provide adequately for all anticipated vehicle movements at intersections at-grade.

E.1.4 DESIGN CONSIDERATIONS

In varying degrees four basic elements enter into the design consideration of at-grade intersection. These elements are:

- traffic factors,
- physical factors,
- economic factors; and
- human factors.

Although intersections have many common factors, they are not subject to class treatment and they must be looked upon as individual problems.

Among the traffic factors the capacity analysis is one of the most important consideration in the design of intersections. Optimum capacities can be obtained when at-grade intersections include auxiliary lanes, proper use of channelization, and traffic control devices. For more complete coverage of capacity of intersections, including procedures for making capacity computations, reference should be made to Chapter B, Traffic and Capacity.

E.2 DESIGN PRINCIPLES

Data relative to the traffic, physical and economic factors must be available before undertaking intersection design. For the redesign of an existing intersection, accident data are also required.

In the redesign of an existing intersection, standards could be modified due to the high cost of existing development, property acquisition or to the necessity of meeting rigid physical controls.

In the design of a new intersection, however, such controls can be minimized by adjusting the highway centre line or grade.

E.2.1 ELEMENTS AFFECTING DESIGN

In analyzing an intersection design, the following basic elements must be considered:

E.2.1.1 Traffic Factors

- (1) Present and projected turning movements and turning volumes, including truck volumes,
- (2) capacity and service volumes, DHV'S, AM & PM peak hours,
- (3) physical and operating characteristics of vehicles,
- (4) vehicle operating speeds approaching the intersection, posted speeds and design speeds,
- (5) accident statistics,
- (6) warrants for traffic signals,
- (7) pedestrian movements,
- (8) parking controls,
- (9) public transit operations,
- (10) regulatory, directional and destination signing.

E.2.1.2 Physical Factors

- (1) Functional classification of the roadways involved,
- (2) basic lane requirements; present and future,
- (3) land use development adjacent to the intersection area,
- (4) site topography,
- (5) grades and sight distances,
- (6) angle of intersection,
- (7) environmental considerations,
- (8) aesthetics.

E.2.1.3 Economic Factors

- (1) Lane costs,
- (2) construction costs,
- (3) maintenance costs,
- (4) compensating costs to business adversely affected by the design,
- (5) cost/benefit comparison of the above.

E.2.1.4 Human Factors

- (1) Driving habits,
- (2) natural paths of movement,
- (3) physical comfort of the driver,
- (4) driver's expectations,
- (5) ability of drivers to make decisions and react,
- (6) effect of surprise (sudden appearance of channelized islands, and other obstructions).

Proper evaluation of these factors enable the designer to evolve an intersection design which will assure an orderly movement of traffic, increase the capacity of the intersection, improve safety by minimizing the conflict points and provide maximum convenience to the travelling public.

E.2.2 TYPES OF MANOEUVRES

At each intersection at grade, the driver of a vehicle is faced with the possibility of four types of manoeuvres:

- . Diverging
- . Merging
- . Weaving
- . Crossing

These manoeuvres are illustrated in Figure E2-1 and the relative severity of the potential conflict of each increases in the order shown.

The right and left vehicle turns at intersections consist of the following types of manoeuvres:

- diverging and merging for the right turn and
- diverging, crossing and merging for the left turn.

The various manoeuvres can be identified in Figure E2-4.

It is the objective of the designer to develop a design which will allow these manoeuvres to be accomplished in a proper and safe manner.

E.2.3 BASIC INTERSECTION FORMS

Intersections can occur in a number of basic forms, as indicated below and shown in Figure E2-2:

- | | |
|-----------------|------------------------------|
| . T | . Cross |
| . T-Skewed | . Cross Skewed |
| . Y | . Multileg |
| . Offset Right | . Single Ramp Channelization |
| . Offset Left | . Fully Channelized |
| . Offset Skewed | . Rotary |

Any one basic intersection form can vary greatly in scope and shape.

The form of an intersection is determined by the needs of that particular intersection. Once the intersection form is established it is a matter of applying the design controls and criteria as well as the elements of intersection design to arrive at a suitable geometric plan.

Intersections should be designed to have a 90° or near 90° angle of intersection and not more than four, two-way intersecting legs. Multileg intersections should be reduced to a maximum of four legs if possible, by realigning the additional legs to intersect on the minor road or if this is not feasible by realigning the legs to the major road at points removed from the intersection. This permits the design of suitable intersection angles for vision and signalization, and allows for easier turning manoeuvres.

Offset intersections are undesirable unless the distance between the intersecting side roads is adequate for weaving and or storage of left turning vehicles. A left offset condition is better than a right off-set, since a vehicle having entered and travelled along the highway can make a non-stop right turn to exit from the highway with a minimum of interference to through vehicles. Rotary intersection designs are not recommended by this Ministry.

E.2.4 CONFLICT AREAS AT INTERSECTIONS

Every at-grade intersection has conflict areas and one of the main objectives of intersection design is to minimize the severity of potential conflicts between all intersection manoeuvres.

A good design will reduce the accident potential by reducing the size of the conflict areas.

The conflict areas are divided into two categories:

- a) Major conflict areas are those where head on or near head on collisions occur, and
- b) minor conflict areas are those where merging type collisions may take place.

Illustrations of conflict areas are shown in Figure E2-3. It should be noted, that the 90° "T" and cross intersections have the smallest conflict areas in comparison to the cross skewed and multileg intersections which have the largest. The conflict points for various manoeuvres at Cross and "T" intersections are shown in Figure E2-4.

Channelized intersections further reduce the conflict area size and the number of vehicles passing through the original intersection point by separating traffic movements into definite paths of travel using pavement markings and islands, see Figure E2-5.

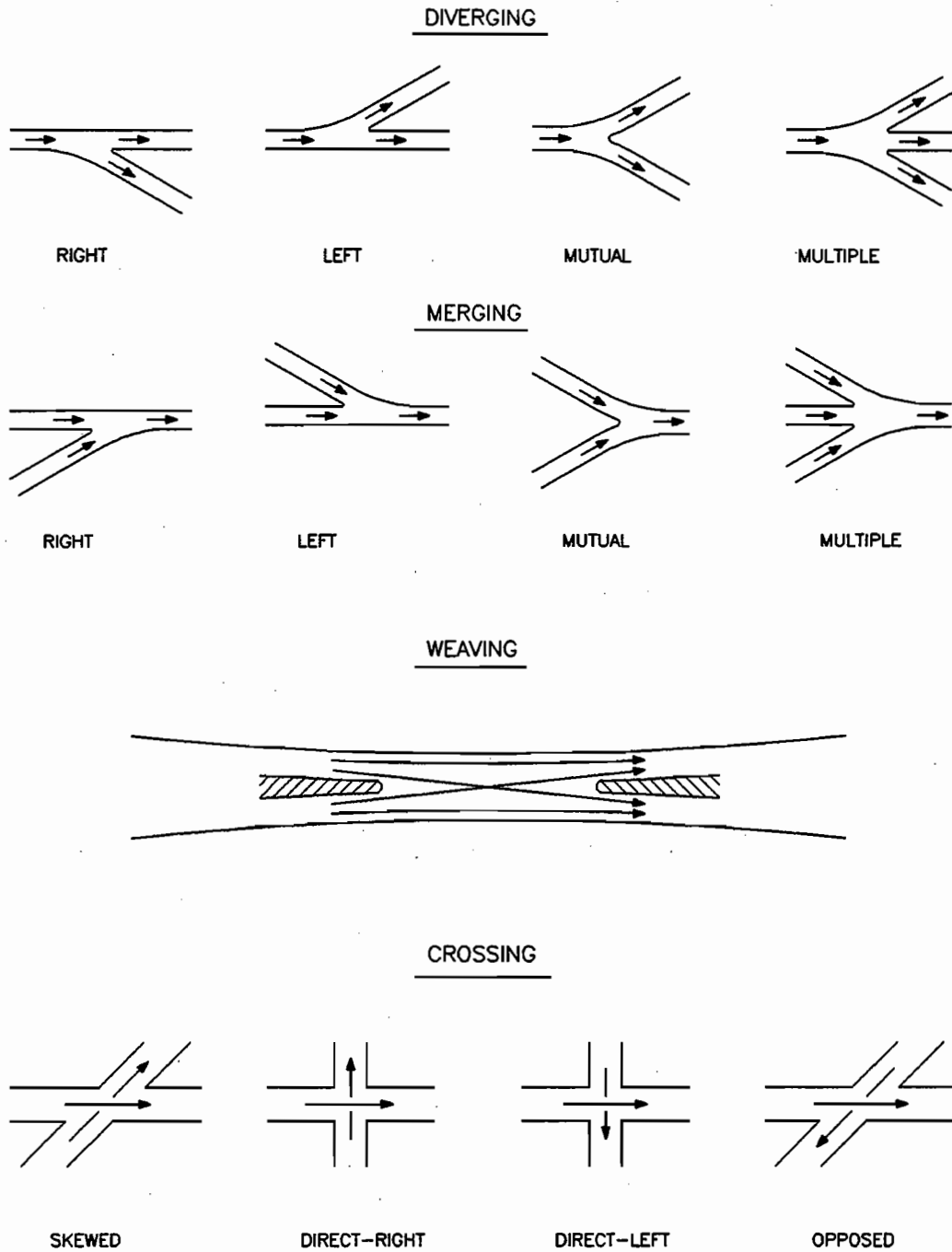
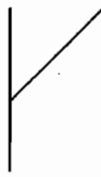

Figure E2-1
Types of Manoeuvres



T



T-SKEWED

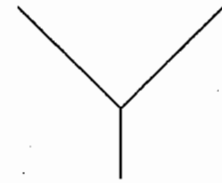

Y



OFFSET RIGHT



OFFSET LEFT

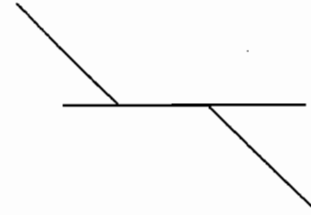

OFFSET SKEWED

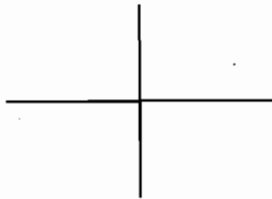

CROSS

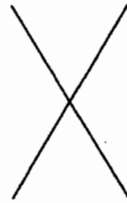

CROSS SKEWED

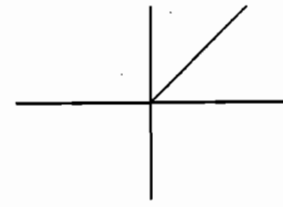

MULTILEG

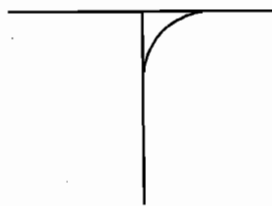

SINGLE RAMP
CHANNELIZATION

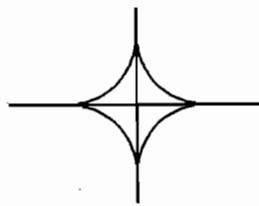

FULLY
CHANNELIZED

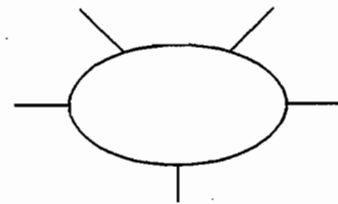

ROTARY

Figure E2-2
Basic Intersection Forms

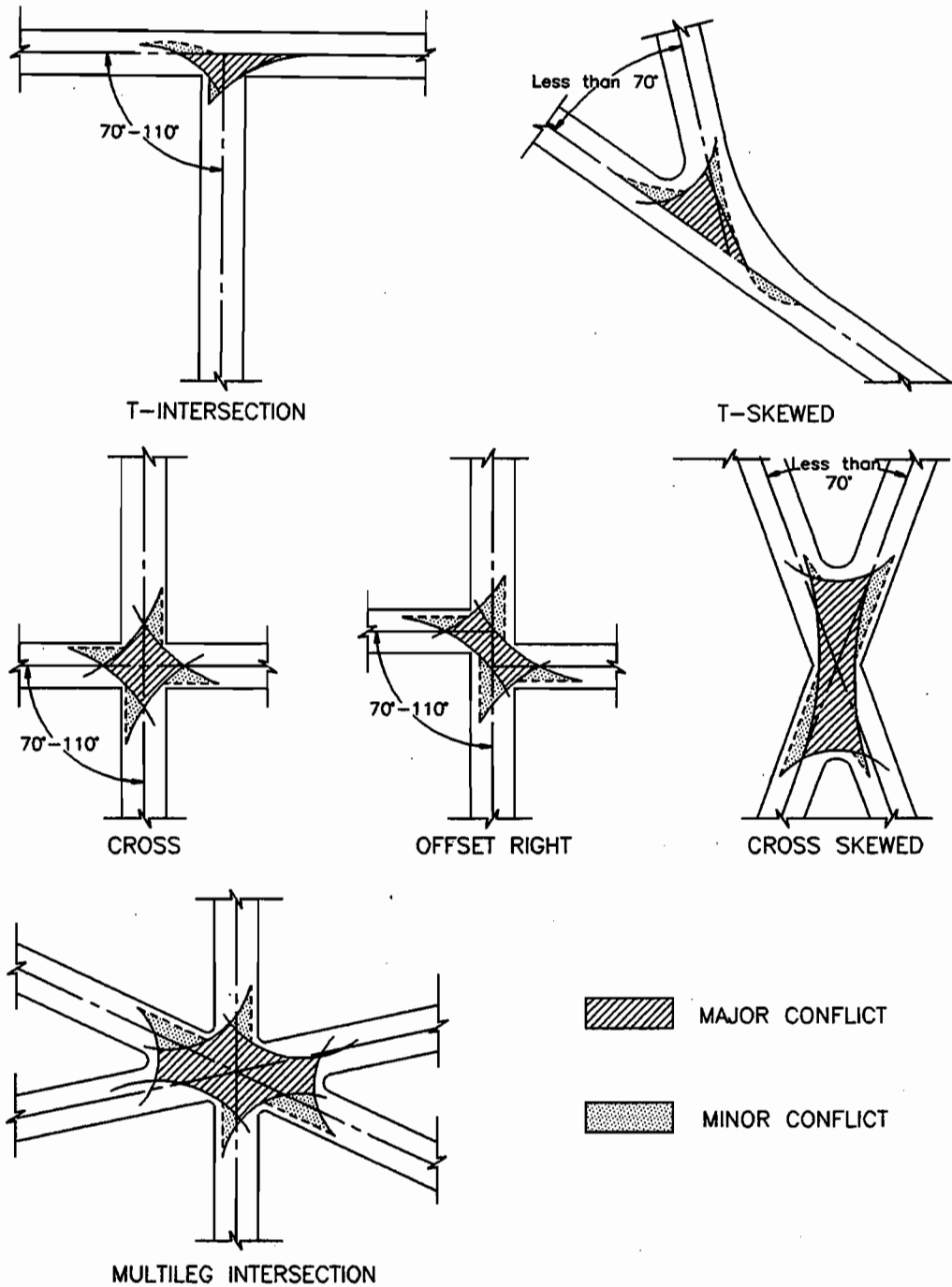
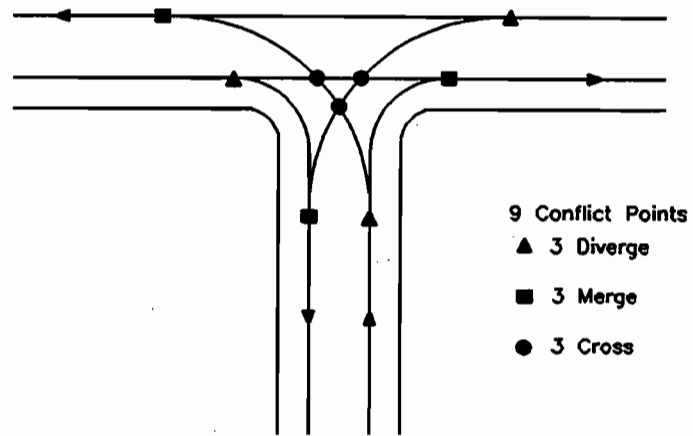
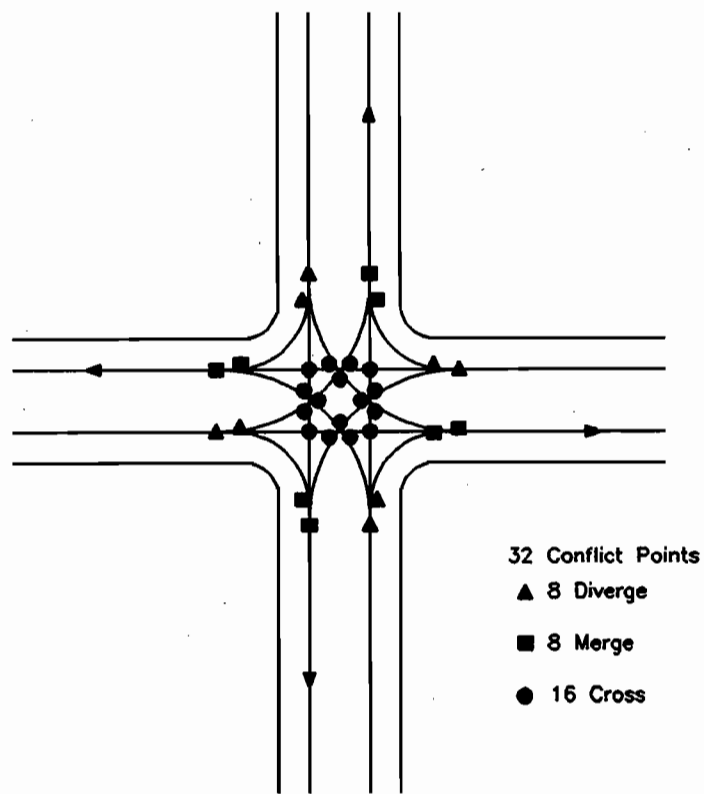

Figure E2-3
Conflict Areas at Intersection



T-INTERSECTION



CROSS-INTERSECTION

Figure E2-4
Conflict Points at Intersection

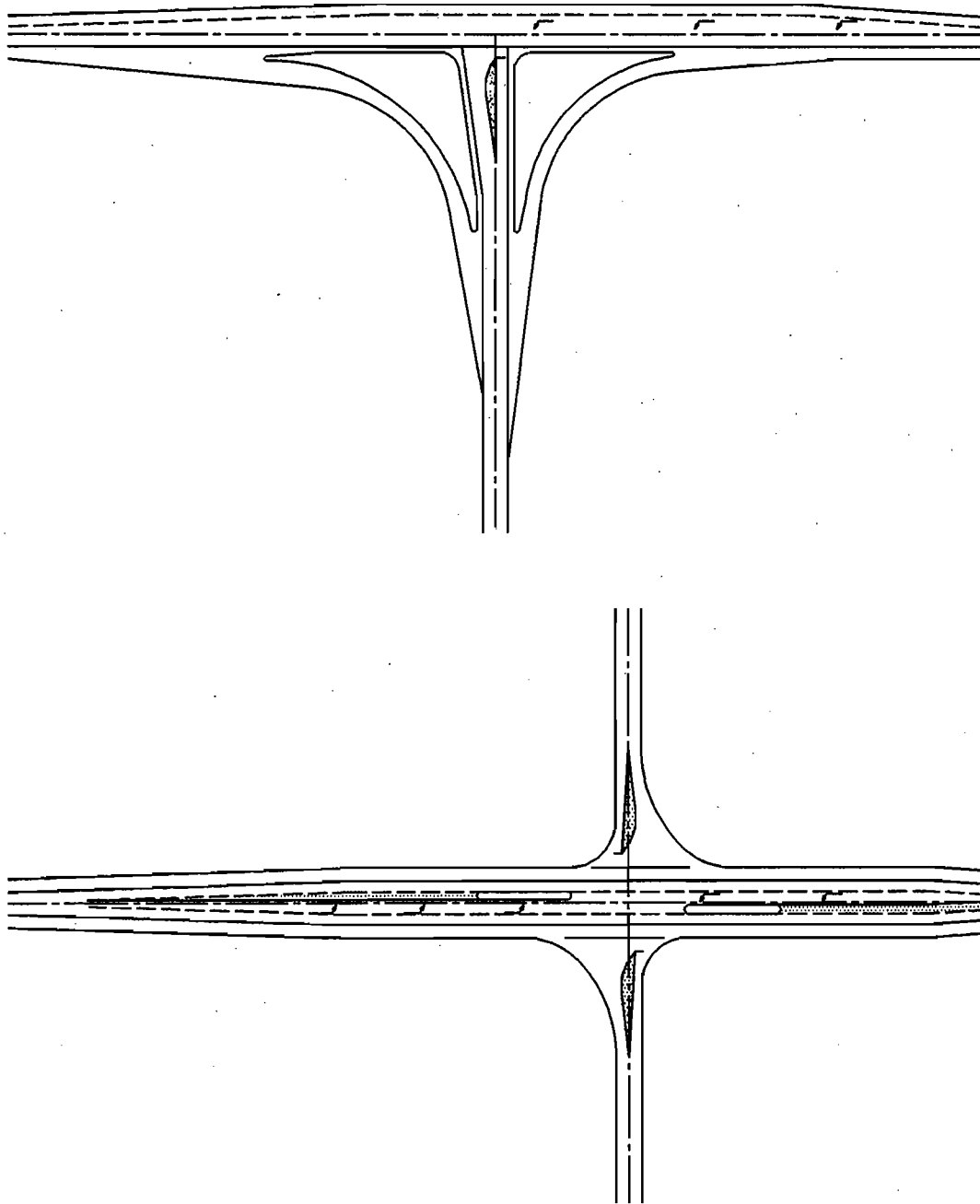

Figure E2-5
Intersections with Reduced Conflict Areas

E.2.5 ANGLE OF INTERSECTION

When two roads intersect it is desirable that the angle of intersection is at or nearly at right angles.

The benefits of a 90° angle of an intersection are:

- (1) Reduced size of conflict area.
- (2) More favourable condition for drivers to judge the relative position and relative speed of an approaching vehicle and to decide when to enter or cross the main road.
- (3) Reduced length of time of a crossing manoeuvre.

The results of vehicular accidents occurring at an impact angle of 90° are generally less severe than those occurring at angles of greater than 90°.

While a crossing at 90° is preferable in most cases, it is sometimes necessary to skew the crossing, and also sometimes advantageous (for instance, to favour a heavier turning movement).

POLICY

INTERSECTION ANGLES LESS THAN 70° OR GREATER THAN 110°, ARE NOT RECOMMENDED.

CONSIDERATION SHOULD BE GIVEN TO MAINTAINING AN ANGLE OF SKEW WITHIN $\pm 10^\circ$ OF RIGHT ANGLE (I.E. BETWEEN 80° AND 100°) WHEN ANY OF THE FOLLOWING CONDITIONS EXIST:

- **TWO SIDEROADS INTERSECTING WITH DHV GREATER THAN 200 ON BOTH ROADS.**
- **SIDEROAD WITH DHV GREATER THAN 200 INTERSECTING WITH ANY KING'S HIGHWAY.**
- **TWO KING'S HIGHWAYS INTERSECTING.**
- **EITHER INTERSECTING ROAD HAS MORE THAN TWO BASIC LANES.**
- **SIGHT DISTANCE IS AT MINIMUM STANDARD.**
- **DESIGN SPEED ON EITHER INTERSECTING ROAD IS GREATER THAN 80 KM/H.**

Skewed "T" intersections intersecting with less than 70° should be treated as outlined in Section E.4.1, Horizontal Alignment.

In the case of a cross intersection, the side road should intersect at the same angle on both sides of the highway. See Figure E2-6.

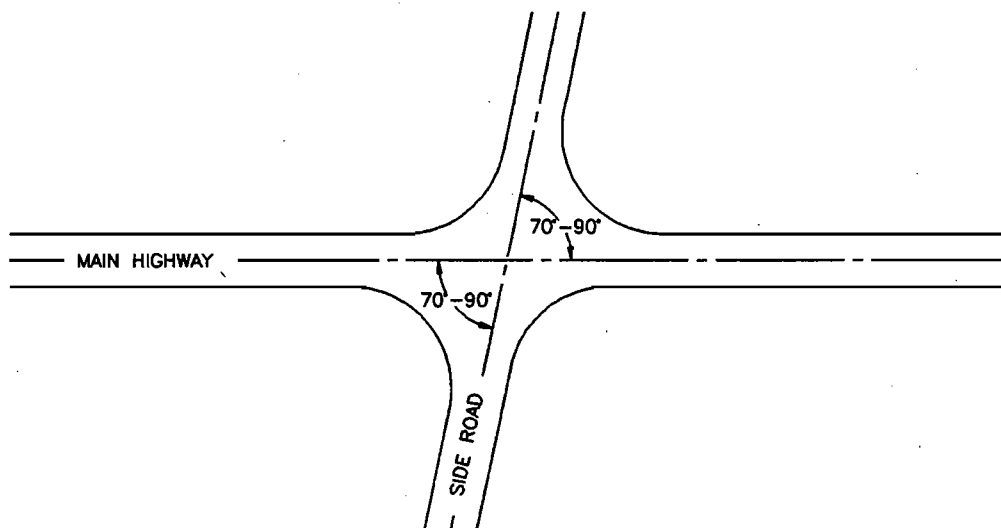

**Figure E2-6
Angle of Intersection**

E.2.6 SIMPLE INTERSECTION DESIGN

The simple intersection design is comprised of two types of intersection treatments having limited improvements in order to facilitate the traffic flow through the intersection area and provide sufficient pavement for the turning vehicles. These are:

- Simple Open Throat and
- Open Throat with Auxiliary Lanes.

E.2.6.1 Simple Open Throat

In the simple open throat design the normal lane width of the main highway and the intersecting road are maintained through the intersection. The simple open throat design provides minimum radii treatment. This type of intersection fits junctions of minor roads and

highways and are designed where one or more of the following conditions exist:

- (1) An area of extensive road side development involving high property cost.
- (2) Low turning volumes.
- (3) Low turning speed (25 km/h or less).
- (4) An intersection of minor road with a through highway.
- (5) Where environmental sensitivities exist.

For detail design of the simple open throat, see Sub-Chapter E.6.

The simple open throat design is applicable to two forms of intersections: the "T" also known as a 3-leg intersection, and the "Cross", also known as a 4-leg intersection, see Figure E2-7. This design is applied where the turning vehicles do not appreciably impede the through traffic.

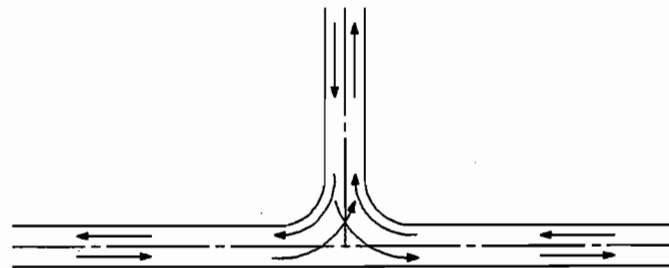

'T' INTERSECTION

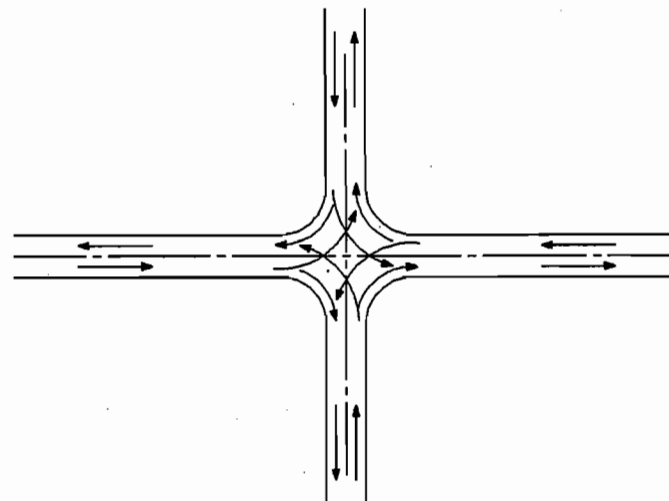

'CROSS' INTERSECTION

**E2-7
Simple Open Throat Intersections**

E.2.6.2 Open Throat with Auxiliary Lanes

The open throat with auxiliary lanes is also referred to as flared intersections and they provide additional lanes and/or tapers for through and turning traffic movements.

Auxiliary lanes may be placed on the right side of the through lanes and between two opposing traffic streams, see Figure E2-8 and E2-9.

Figures E10-10 and E10-11 illustrate the design of auxiliary lanes for divided highways on the left side of the through lanes.

Auxiliary lanes are used for vehicles either entering or leaving the through traffic lanes and function as acceleration or deceleration lanes and tapers.

Auxiliary lanes reduce the hazard caused by turning vehicles and increase capacity. Left turns from the through highway are particularly hazardous because vehicles must slow down and often stop before completing the turn, while an auxiliary lane enables the following through vehicles to manoeuvre around the slower turning vehicles.

Open throat with auxiliary lane design is applied where speeds are higher and turning movements are of sufficient numbers to increase accident potential.

Figure E2-8(a) shows an added lane on the side of the through highway adjacent to the intersecting road acting as a speed change lane for right turns. This arrangement is applicable where the right turning movement from the through highway is substantial but does not exceed 60 vehicles per hour and the left turning movement from the through highway is minor.

Figure E2-8(b) shows an added lane on the side opposite the intersecting road. This arrangement is applicable where the left turning movement from the through highway is substantial but insufficient to warrant a left turn lane, and the right and left turning movement from the side road is minor. The added lane affords the opportunity for the following through drivers to pass on the right of the slower moving or stopping vehicles preparing to turn left. For details see "slip around" design in Section E.9.1.2.

Figure E2-8(c) shows the added lane in the middle of the through highway. The additional lane is used for left turns from and to the highway. A driver turning left from the through highway naturally edges towards the centre and through traffic is encouraged to pass on the right of the vehicle slowing down or stopping to turn left. For left turn storage lane warrants see Sub-Chapter E.9.

The arrangements shown in Figures E2-8(a) and (c) are also applicable to cross intersections. The "slip around" shown in Figure E2-8(b) is applicable to "T" intersections only.

Figure E2-9 illustrates an open throat intersection with auxiliary lanes by adding a right turn lane on each side of the through highway. Such an arrangement may be appropriate where the capacity of the 2-lane highway at the intersection is taxed by the traffic volume and where signal control is required.

Auxiliary lanes and tapers are covered in detail in Sub-Chapters E.7 and E.9.

E.2.7 CHANNELIZATION DESIGN

Where an at-grade intersection has large uncontrolled paved areas and traffic volumes are greater than those normally found at simple open throat and open throat with auxiliary lanes intersections, a channelized design may be applied. Conflicts may be reduced in extent and severity by the use of channelizing islands, directing traffic movements into specific and clearly defined paths.

E.2.7.1 Criteria and Functions of Channelization

Traffic volumes, speeds and the type of roadways forming the intersection are the essential factors considered in the channelization design.

At rural locations where high speeds are prevalent, and accidents are usually of a more severe nature, channelization is usually used for safety purposes.

In urban areas where speeds are lower, but where traffic volumes are usually higher, channelization is used primarily to increase the capacity of an intersection.

POLICY

THE RIGHT TURN CHANNELIZATION VOLUME CRITERIA PRESENTLY IN USE IS APPROXIMATELY 60 VEHICLES FOR THE DESIGN HOUR.

Channelization may be used for one or more of the following functions: (The figures referred to illustrate concepts only and do not represent actual design.)

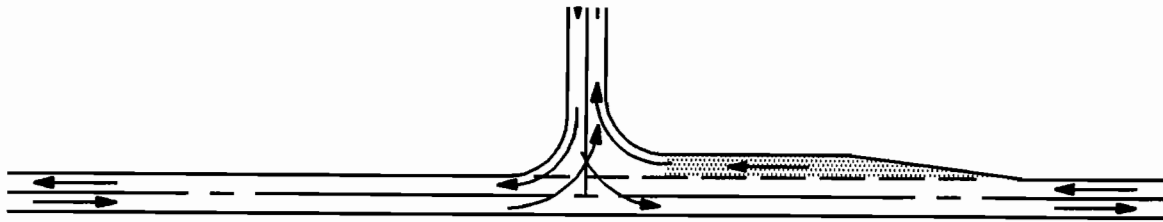

(a) ADDED LANE ADJACENT TO INTERSECTING ROAD

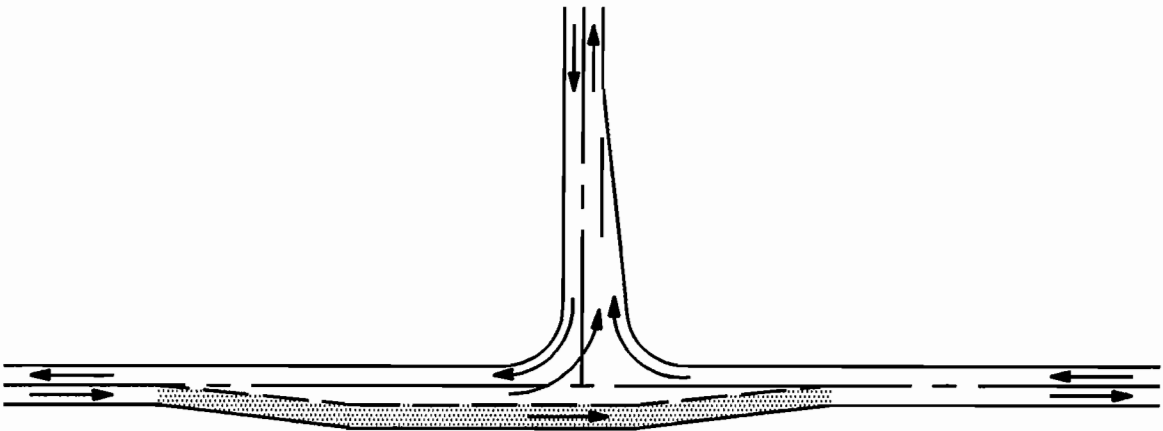

(b) ADDED LANE OPPOSITE INTERSECTING ROAD

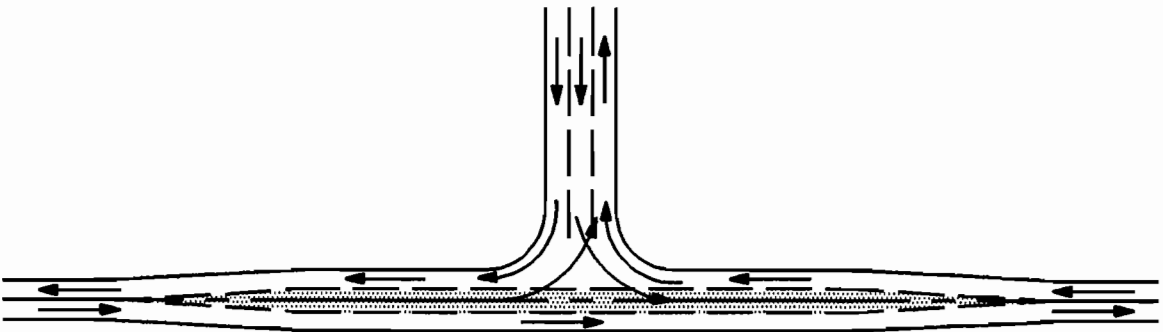

(c) ADDED LANE IN CENTRE

Figure E2-8
Open Throat Intersections with Auxiliary Lanes for
'T' Intersections

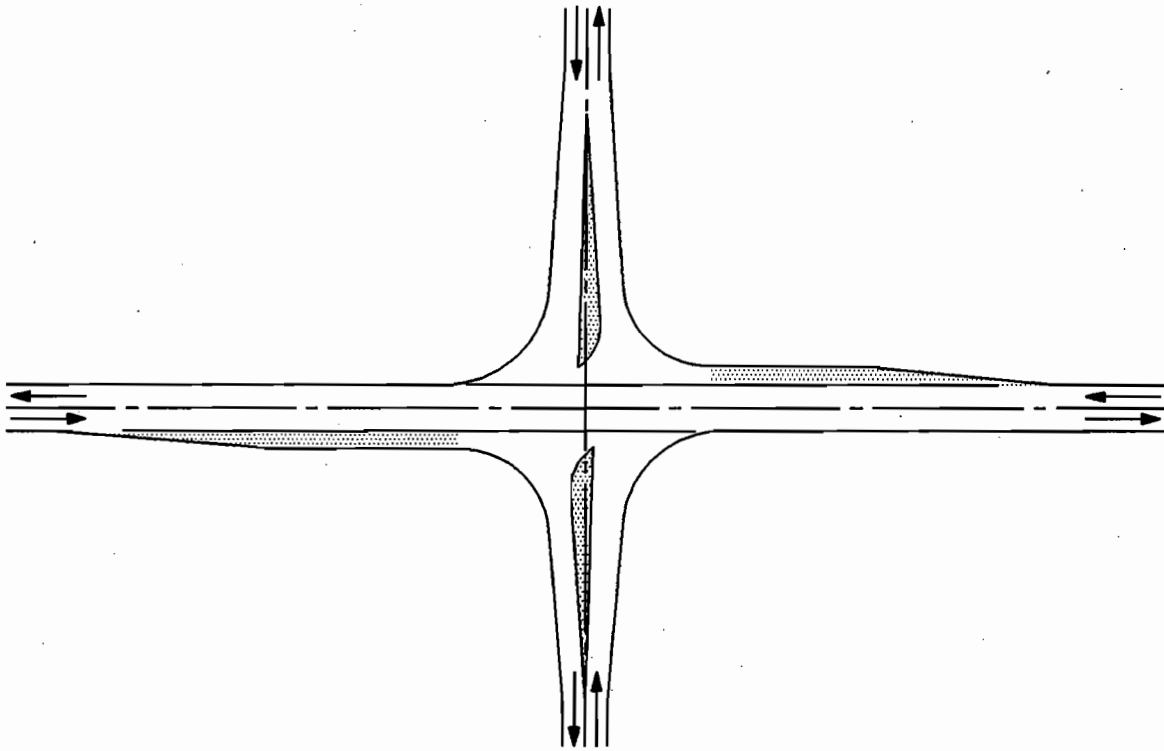

Figure E2-9
Open Throat Intersection with Auxiliary Lanes
for Cross Intersection

- (1) To separate conflicts caused by the overlapping of manoeuvre areas. This separation makes it possible to present the driver with only one important decision at a time. See Figure E2-10.
- (2) To control the angle of conflict and reduce relative speed differentials in merging, diverging, weaving and crossing manoeuvres. The potential severity of conflict may be decreased substantially by reducing the angle between the vehicle paths. See Figure E2-11.
- (3) To reduce excessive pavement areas caused by skewed and flared intersection arrangements. Large areas of open pavement may confuse drivers and cause erratic and improper manoeuvres. See Figure E2-12.
- (4) To control speed by bending and directing movements to support yield sign controls or reduce speed differentials prior to merging and weaving manoeuvres. See Figure E2-13.
- (5) To protect and store turning and crossing vehicles by enabling them to slow down or move out of the path of other traffic flows, and to protect pedestrians by providing a safe refuge between traffic streams. See Figure E2-14.
- (6) To block prohibited movements by making it impossible or inconvenient to perform illegal, improper or unsafe manoeuvres. See Figure E2-15.
- (7) To segregate traffic movements with different requirements in terms of speed, direction and stop or right-of-way control. See Figure E2-16.
- (8) To locate and protect traffic control devices such as signs, signals and illumination poles where the most desirable location for these devices is within the intersection area. See Figure E2-17.

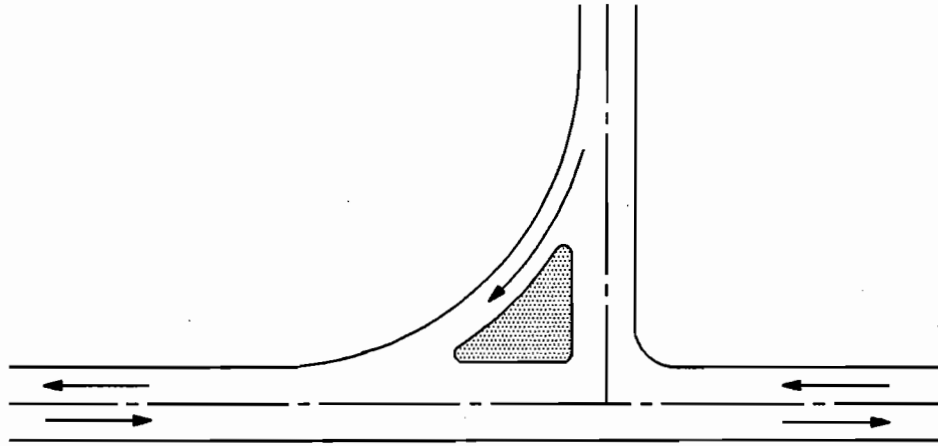

Figure E2-10
Separation of Conflicts

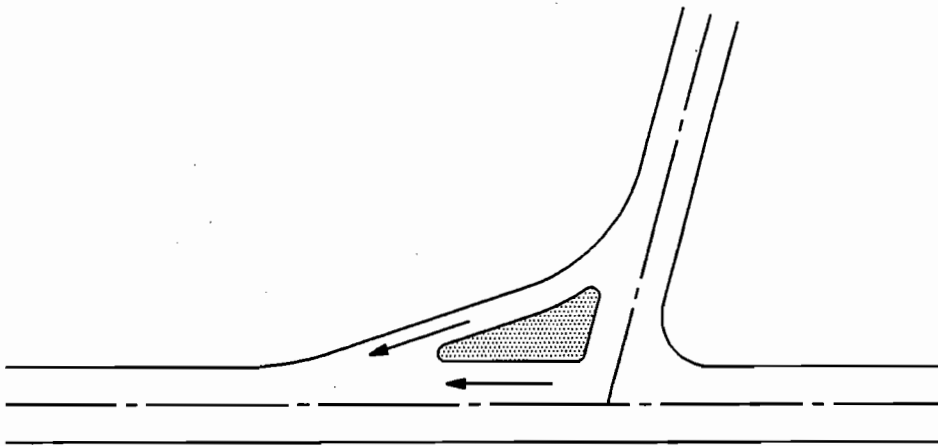

Figure E2-11
Merging at a Flat Angle

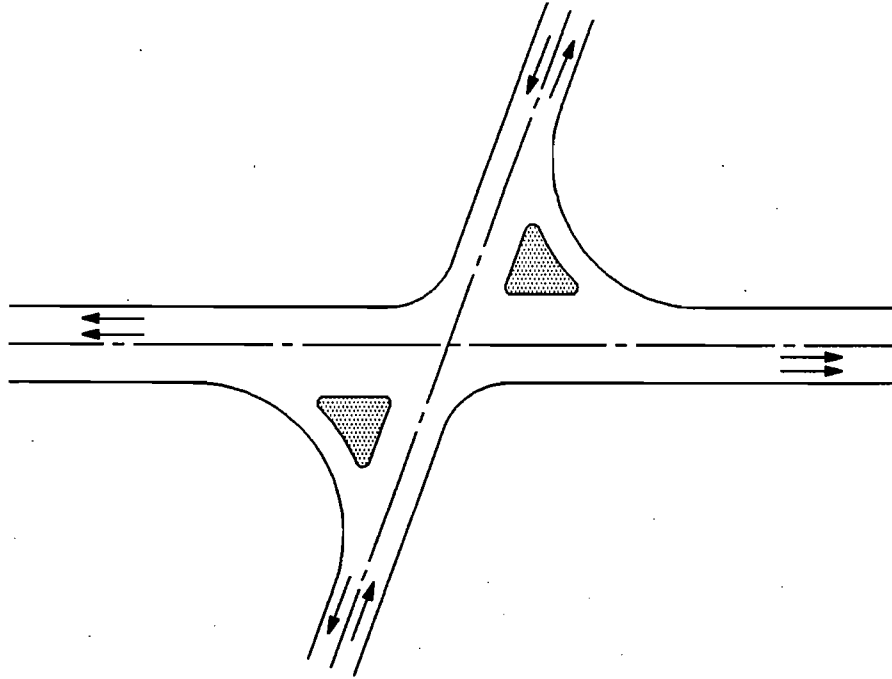

Figure E2-12
Control of Paved Areas by Use of Islands

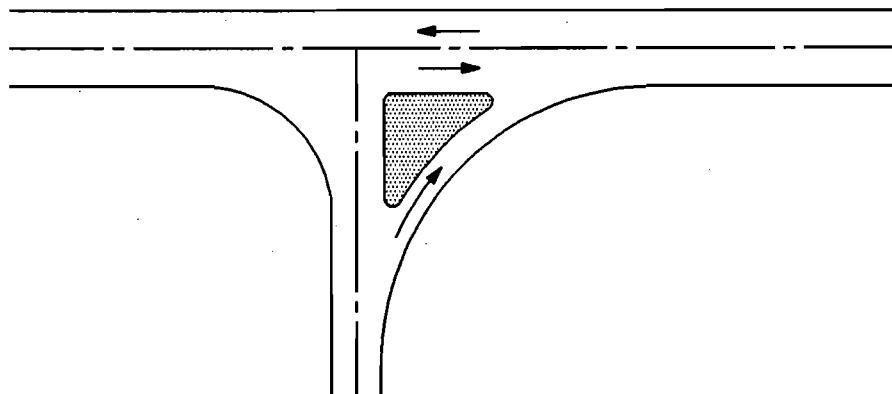

Figure E2-13
Speed Control

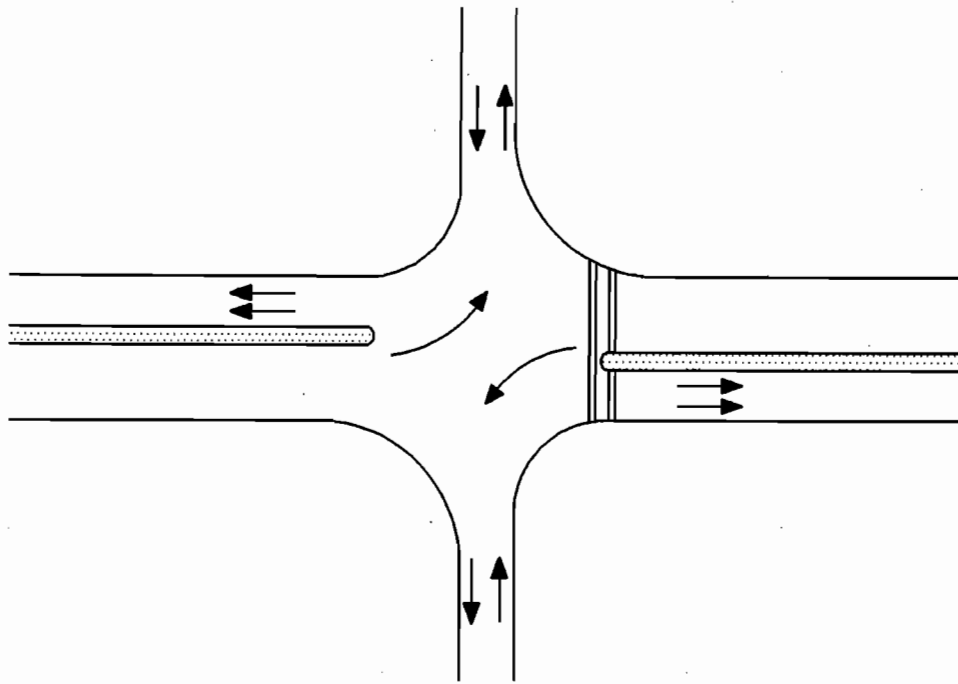

Figure E2-14
Refuge for Turning Vehicles and Pedestrians

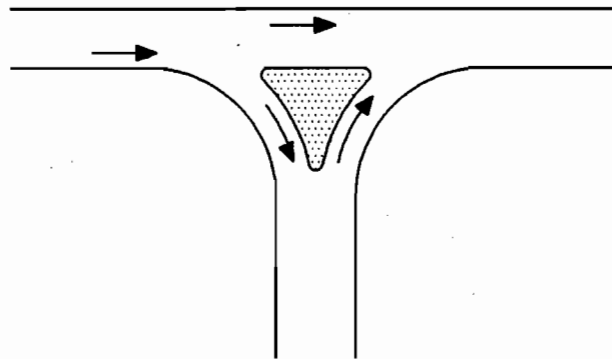

Figure E2-15
Control of Prohibited Turns

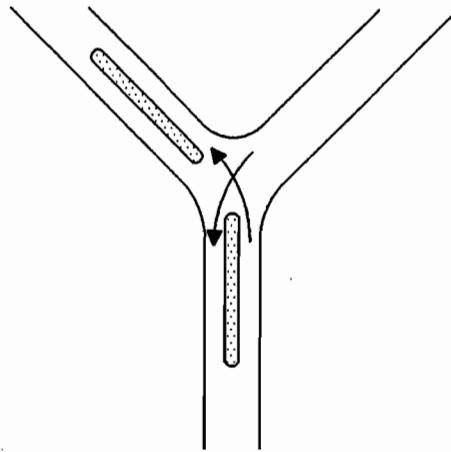

Figure E2-16
Segregation of Traffic Movements

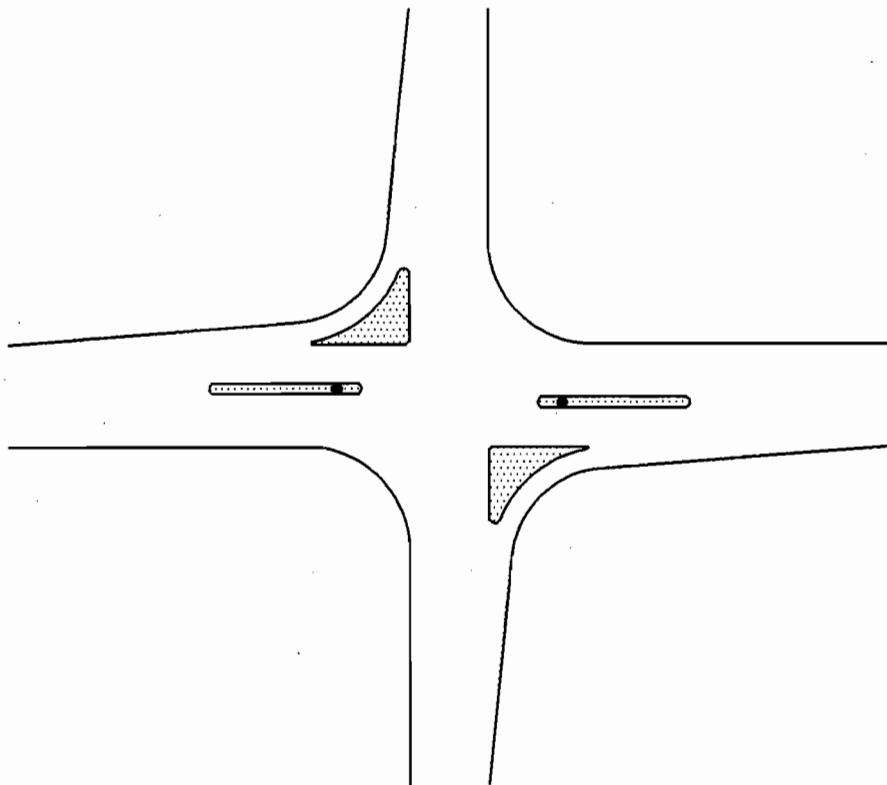

Figure E2-17
Islands for Location of Traffic Poles

E.2.7.2 Principles of Channelization Design

Channelization design does not lend itself to standardization. Traffic volumes, pedestrian movements and physical conditions vary, requiring individual treatment of each intersection. The combination of various design elements within a specific design requires engineering judgement.

Good design should adhere to the following principles:

- (1) The proper traffic channels should seem natural and convenient to drivers and pedestrians and the channelizing islands should be placed so that the proper course of travel is immediately obvious and easy to follow. Unnatural paths, such as reversed curvature or left turn manoeuvre requiring an initial turn to the right, should be considered only under special situations.
- (2) There should be only one well defined vehicle path to a destination providing the driver of the vehicle with no alternative in selecting the path of travel.
- (3) Channelization should be well defined and clearly visible. It should not be introduced where sight distance is limited. When an island must be located near a high point in the roadway profile, or near the beginning of a horizontal curve, the approach end of the island should be extended so that it will be obvious to approaching drivers.
- (4) The major traffic flow should be favoured. When curved alignment is unavoidable at intersections, the highway with the heavier traffic volume and higher speed should have the flatter curvature.
- (5) Traffic streams that cross should intersect at or near right angles.
- (6) Angle of intersection between merging streams of traffic should be small.
- (7) Drivers should not be confronted with more than one conflict and should not have to make more than one decision at a time.
- (8) Area of vehicle conflict should be reduced as much as possible. However, merging and

weaving areas should be as long as conditions permit. Channelization should be used to keep vehicles within well defined path that minimize the area of conflict.

- (9) The number of islands should be held to a practical minimum to avoid confusion.
- (10) Islands should be large enough to be effective as a method of guidance and not present problems in maintenance.
- (11) The approach end treatment and delineation of the islands should be consistent with the design speed of the roadway.

E.2.7.2.1 Merging conditions with and without Speed Change Lanes

Figure E2-18 compares the high and low relative speed differential that may occur at the merge end of a separate right turn lane. In the upper diagram (undesirable design) an acceleration lane has not been provided, therefore, the manoeuvring and merging takes place over a very short distance and at an angle greater than 10°. The large speed differential created requires the merging vehicle to yield or stop before entering the highway. This type would only be acceptable under tight urban conditions.

In the lower diagram (desirable design) a full acceleration lane has been provided permitting the merging vehicle to enter at a flat angle or to utilize the full length of the acceleration lane to select a gap and complete the merge manoeuvre at a speed close to through traffic.

The latter condition is recommended in channelization design.

E.2.7.3 Islands**A. Definition and Delineation**

An island is a defined area between traffic lanes for control of vehicle movements or for pedestrian refuge. Islands may be raised areas or may be marked out simply in paint on the pavement surface. The most desirable and commonly used treatment is the raised island with mountable curbs. In some cases barrier curbs are required to protect pedestrians and prevent vehicles striking poles, etc.

Delineation and approach end treatment is critical to good channelization design. Island delineation can be divided into the following types:

- (1) Raised islands outlined by curbs. This type can be applied universally and is the most positive. Mountable curbs should be used in most cases.
- (2) Islands delineated by pavement markings. This type of island is generally designed in urban or semi-urban areas where speeds are low and space is limited. Application of this type of island may be considered in rural areas in advance of raised median island.
- (3) Non-paved areas formed by pavement edges possibly supplemented by delineators or posts, other guide posts, a mounded earth

treatment or appropriate landscaping. This type necessarily applies to larger islands and is used mostly at rural intersections where there is sufficient space.

- (4) Temporary island installations. This type is usually constructed of asphalt curbing, precast bumper curbing or sand bags.

B. Functional Classes of Islands

Islands can be grouped into three functional classes as follows:

- (1) Directional Islands
- (2) Divisional Islands
- (3) Refuge Islands

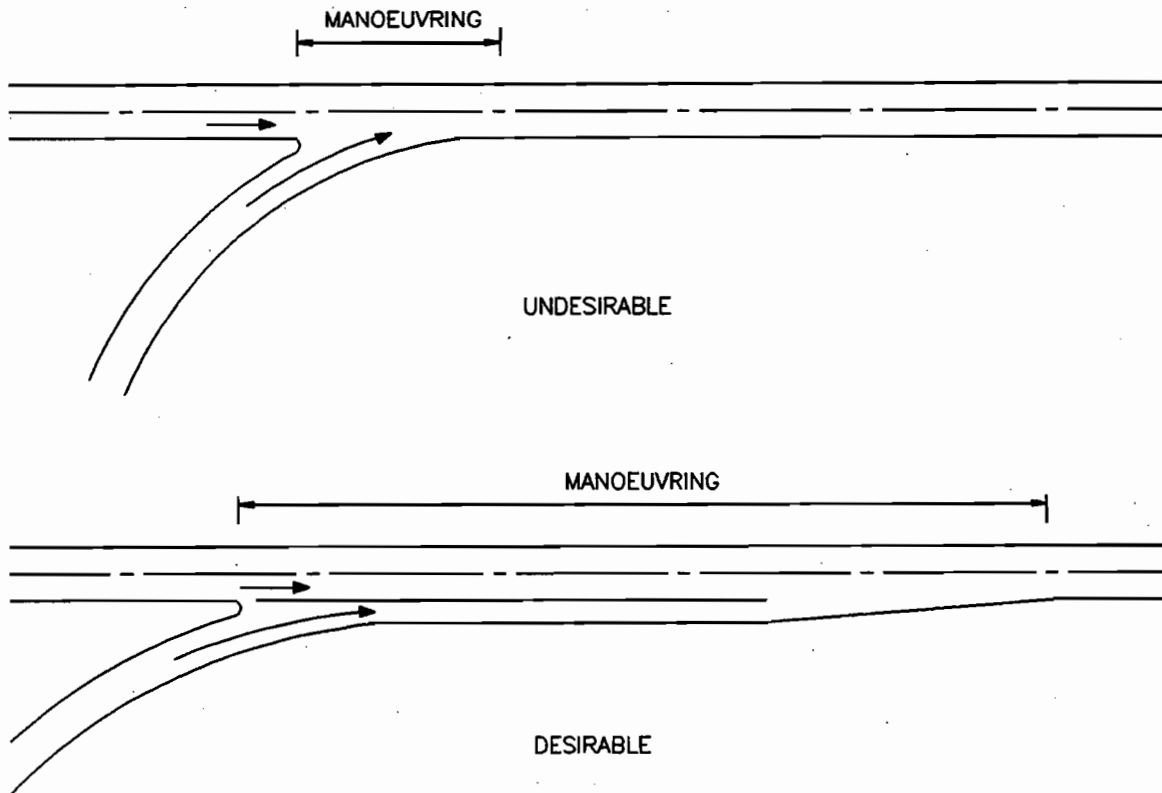

Figure E2-18
Merging Condition with and without Speed Change Lane

(1) Directional Islands

Directional islands are used in conjunction with a separate right turn lane design. See Figure E2-19. For details, see Section E.8.14, Directional Islands.

(2) Divisional Islands

Divisional Islands also called raised median islands, usually separate two traffic lanes in opposite direction where the highway cross-section consists of five lanes or more and the islands are required for traffic control devices. They also guide and protect vehicles entering the left turn lane, see Figure E2-20. For details, see Section E.10.1, Divisional Islands.

(3) Refuge Islands

Refuge Islands have barrier type curbs and are generally used at or near crosswalks to aid or protect pedestrians crossing the roadway, particularly at intersections in urban areas where complex signal phasing is used. Directional and divisional islands may serve as refuge islands when the need arises. See Figure E2-21.

It is undesirable to locate curbed islands in the centre of a highway as they are considered hazardous objects, particularly in high speed rural areas. However, depending on the cross-section of the highway, it often becomes necessary, at signalized intersections, to place signal poles and islands in the medians.

C. Island Shape

The shape of directional islands is the result of ramp and roadway alignments and intersection angle. Islands generally are either elongated or triangular in shape and are situated in areas normally not used as vehicle paths, the dimensions depending upon the particular intersection layout. See Figure E2-19.

The shape of a divisional island is elongated and is usually parallel to the direction of traffic lanes. See Figure E2-20.

The shape of a refuge island may vary depending on pedestrian needs and intersection configuration. Refer to illustrations of the directional and divisional islands. See Figure E2-21.

D. Island Design Objectives

When designing an island the designer should assure that its location and configuration does not result in a hazard to the travelling public. Other considerations are that they be relatively inexpensive to build and easy to maintain. The islands should occupy a minimum of roadway space and yet be commanding enough that motorists will not drive over them inadvertently or deliberately.

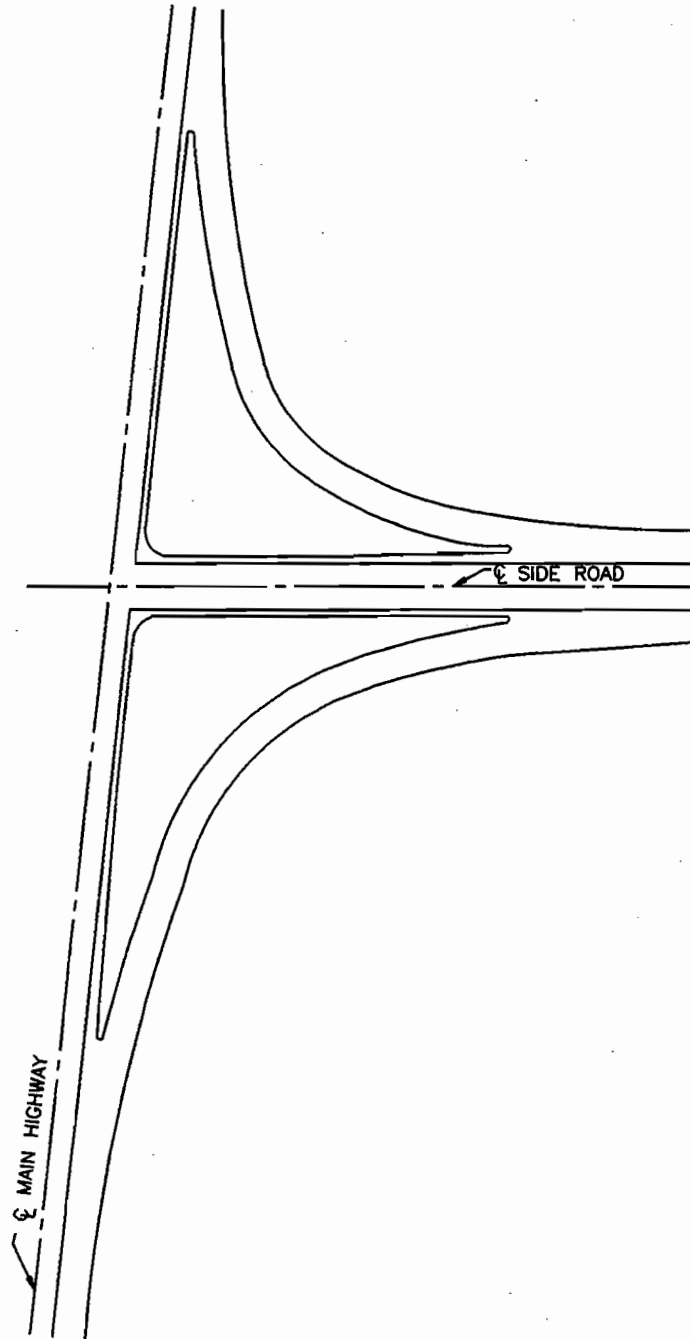

Figure E2-19
Directional Islands

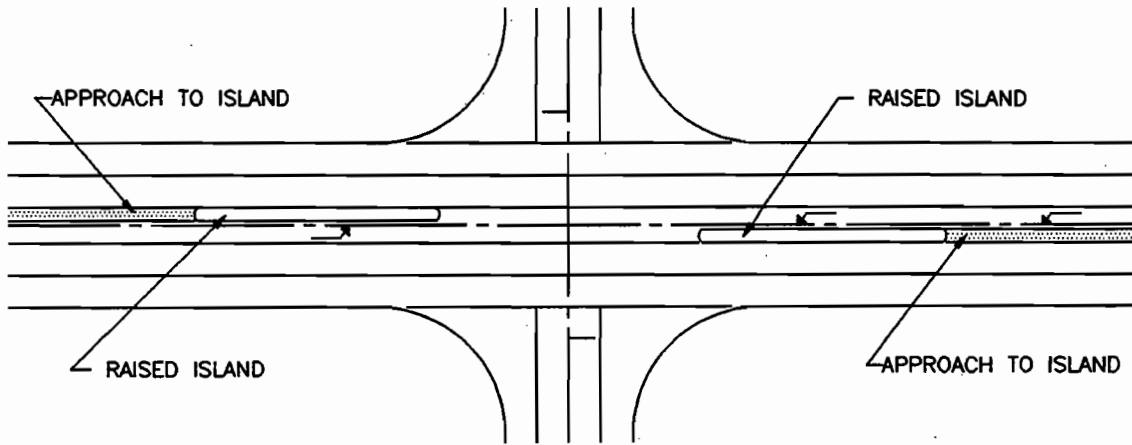

Figure E2-20
Divisional Islands

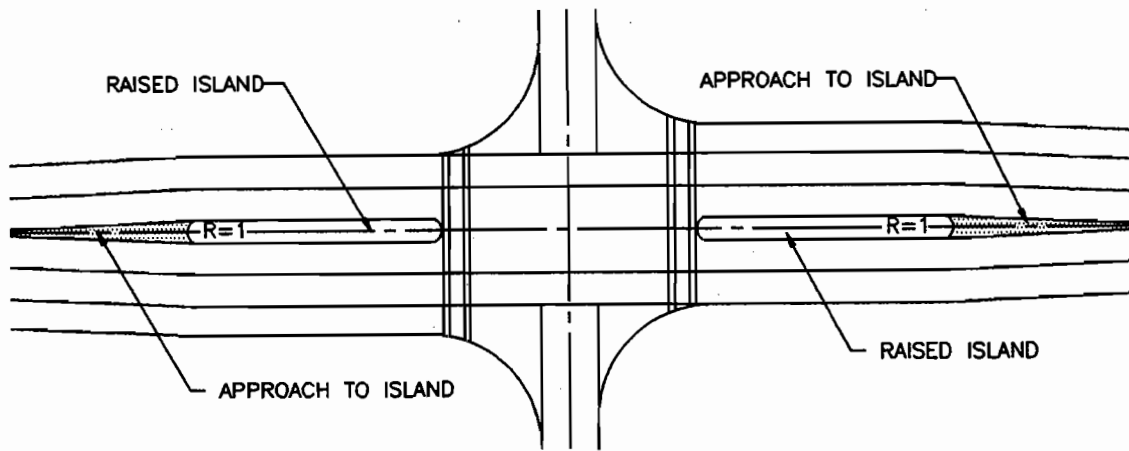

Figure E2-21
Refuge Islands

E.3 SIGHT DISTANCE AT INTERSECTIONS

Although there are potential vehicle conflicts at every intersection, the possibility of these conflicts actually occurring can be greatly reduced through proper channelization and appropriate traffic controls. But the avoidance of accidents and the efficiency of traffic operation must still depend to a large extent upon the judgement, capabilities and responses of the individual driver.

POLICY

THE INTERSECTION DESIGN MUST PROVIDE SUFFICIENT SIGHT DISTANCES FOR THE DRIVER TO PERCEIVE POTENTIAL CONFLICTS AND TO CARRY OUT THE ACTIONS NEEDED TO NEGOTIATE THE INTERSECTION SAFELY.

Sight distance requirements must be considered both for vehicles approaching the intersection and departing from the stopped position at the intersection.

E.3.1 MINIMUM SIGHT TRIANGLE**E.3.1.1 Approaches**

On the approaches to an intersection the required sight distances depend upon the approach speeds:

V_a - on the main highway,
 V_b - on the side road and

the particular action that the drivers may be required to take before reaching the point of potential conflict.

In general each driver has four possible actions: to accelerate, continue at present speed, slow down or stop.

The correct position of the sight line is established by determining:

d_a - the approach distance on the main highway and
 d_b - the approach distance on the side road.

The area within the triangle formed by the approach distances and sight line must be clear of sight obstructions.

Minimum sight triangles for various approach conditions are shown in Figure E3-1, a) and b). These exemplify the sight conditions from point B to point A on the left from the side road approach. A similar sight line for the minimum sight triangle is established from point B to the vehicle approaching from the right on the main highway.

E.3.1.2 Departures

After a vehicle has stopped at an intersection, the driver must have sufficient sight distance to make a safe departure and crossing of or turning within the intersection area.

Figure E3-2 a), b), and c) indicate the required sight lines for a safe crossing or turning manoeuvre from a stopped position. Distances ' d_a ' are the lengths travelled by vehicles at the design speed ' V_a ' of the main highway during the time it takes for the stopped vehicle to leave its stopped position and clear the intersection over the distance $S = D + W + L$ or make a turn to the left or to the right.

The intersection design should provide adequate sight distance for each of the vehicle manoeuvres permitted upon departure from a stopped position as described in Sub-Section E.3.2.3, Stop Control.

E.3.2 INTERSECTION TRAFFIC CONTROLS

The method of establishing the required sight distances along the intersection approaches and the resulting position of the required sight line is determined by the type of traffic control to be used on the intersection approaches. Four different cases are considered.

1. No control
2. Yield control
3. Stop control
4. Signal control

E.3.2.1 No Control

At intersections without traffic control signs or signals, it is desirable to have sufficient sight distance on each approach to enable a driver to see a vehicle on the intersecting road and to bring his vehicle to a stop before entering the intersection. See Figure E3-1 a) and b). The approach sight line for this requirement is based on distances ' d_a ' and ' d_b ' along the approaches equal to the minimum stopping sight distance for the design speed of the approach. These distances are given in Table E3-1.

Where the available sight distances in Figure E3-1 a) and b) are limited, it is necessary to relocate an obstructing object or reduce the approach speed on the side road in order to ensure a clear sight triangle. A revised value for ' d_b ' is determined which in turn would be referenced to Table E3-1 to obtain reduced approach speed on the side road.

V_a - Approach Speed on Main Highway
 V_b - Approach Speed on Side Road
 d_a - Approach Distance on Main Highway
 d_b - Approach Distance on Side Road

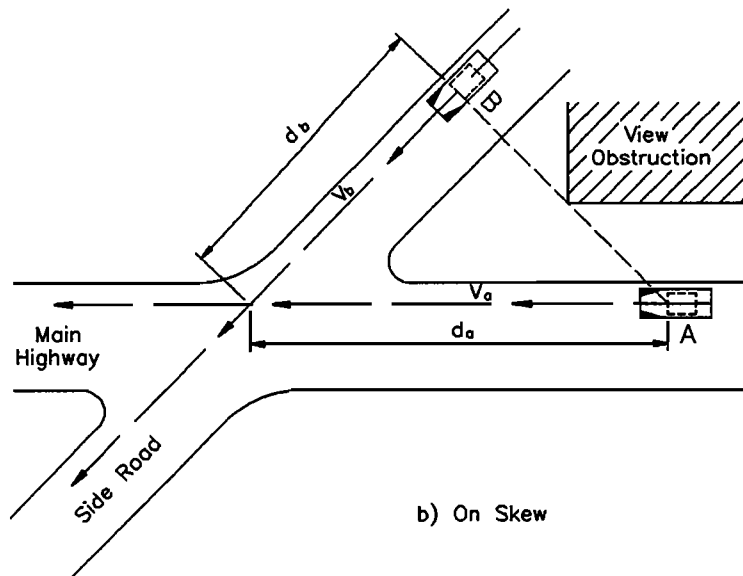
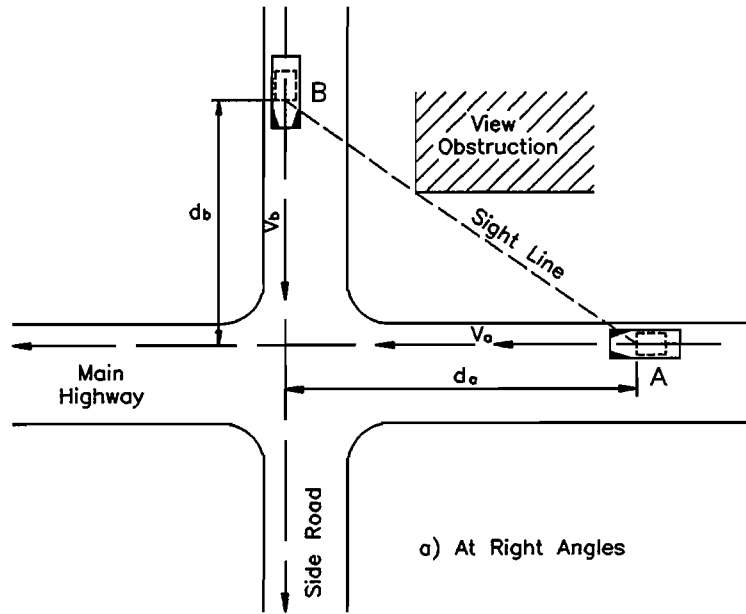

Figure E3-1
 Sight Distance at Intersections for Approaches

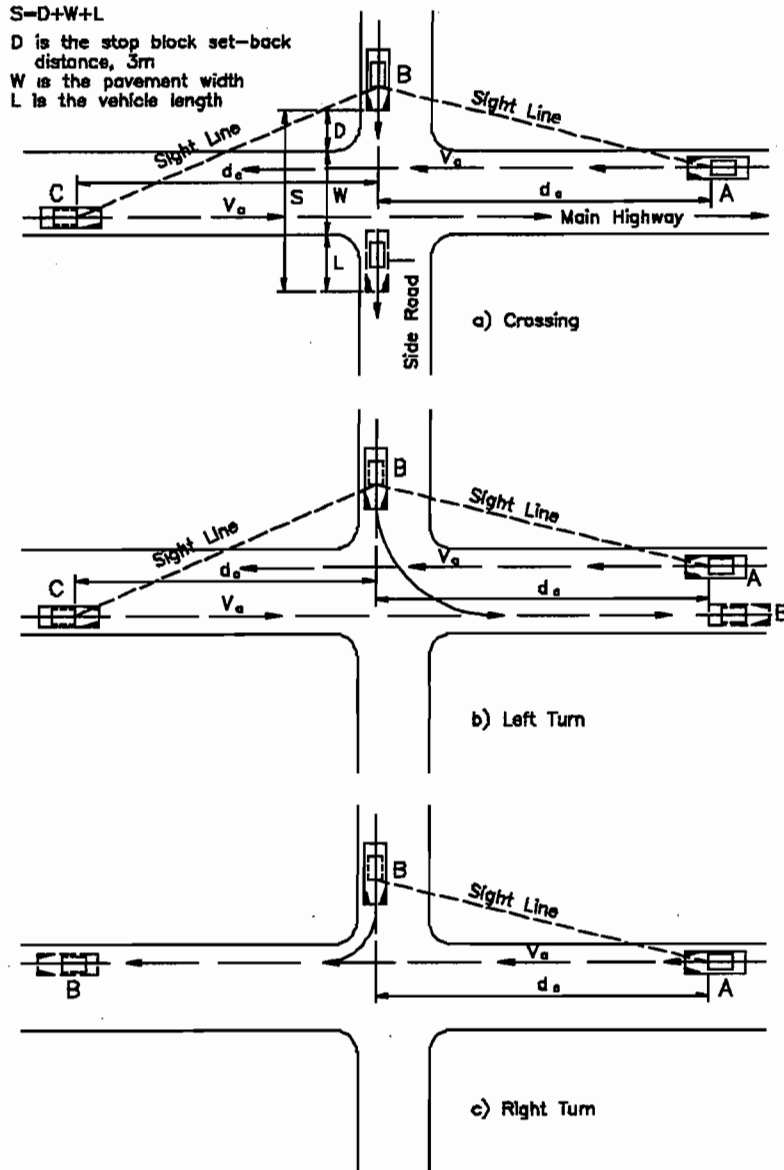

Figure E3-2

Sight Distance at Intersection for Departures

Design Speed, km/h	20	30	40	50	60	70	80	90	100	110
Minimum Stopping Sight Distance, m	20	30	45	65	85	110	135	160	185	215

**Table E3-1
Minimum Stopping Sight Distance**

The no control condition may be adequate at the intersection of a local road with a local road where the following conditions exist:

- the total AADT for the intersection is 1000-1500 vehicles or less;
- the safe approach speed (stopping sight distance) is approximately equal to or greater than the 85 percentile speed or the speed limit whichever is less;
- accident history indicates two or less right angle collisions per year.

As an absolute minimum requirement, drivers approaching an uncontrolled intersection must have at least sufficient sight distance to adjust their speeds to avoid collision while continuing through the intersection. For this situation three seconds are needed along each approach roadway for driver perception, reaction and braking. Distances required to allow three seconds are listed in Table E3-2 for various approach speeds.

It is assumed that vehicles will seldom be required to stop at uncontrolled intersections. In the event that a vehicle has to stop, the sight distance requirements for departure would be the same as those shown for stop control.

E.3.2.2 Yield Control

Where an intersection is controlled by a yield sign, on the side road it is assumed that a driver on that approach will reduce speed sufficiently to enable him/her to stop or to accelerate and pass through the intersection. The sight line for this condition is established by applying:

- the minimum stopping sight distance at a reduced speed along the controlled side road and

- the minimum stopping sight distance along the uncontrolled highway.

For design values see Table E3-1.

Suggested speeds on the yield controlled approach are:

- urban conditions - 20km/h,
- rural conditions - 30 or 40 km/h.

See Table E3-1 for the minimum stopping sight distances relating to these speeds.

The yield control condition is most applicable to the intersection of a local road with a local road or a local road with a collector under the following conditions:

- total AADT entering the intersection is 1500-3000 vehicles;
- a safe approach speed (stopping sight distance) is equal to or greater than 20 km/h;
- a history of three or more right angle accidents per year.

The sight line for the safe departure and crossing of a standing vehicle on the yield controlled side road is established in the same manner as for stop control, as discussed below.

E.3.2.3 Stop Control

POLICY

THE SIGHT DISTANCE ALONG THE MAJOR HIGHWAY SHOULD BE MEASURED FROM THE HEIGHT OF THE TURNING VEHICLE DRIVER'S EYE OF 1.05 M TO THE TOP OF THE APPROACHING VEHICLE 1.3 M ABOVE THE PAVEMENT. FOR THE EFFECT OF GRADE, TABLE C2-3 SHOULD BE APPLIED.

Design Speed, km/h	30	40	50	60	70	80	90	100	110
Distance, m	25	30	40	50	60	65	75	85	95

**Table E3-2
Minimum Distance Travelled in 3 s**

While all vehicles must stop on the side road at the stop sign controlled intersections, certain sight distances should be provided on the approach for the main highway in case a driver violates the stop sign.

The sight line and property requirements for this condition and for the purpose of providing daylighting or visibility on a two and four-lane highway, can be derived from Table E3-3 for intersections having a 90° intersection angle. The size of the daylighting or visibility triangle is a function of the number and width of lanes, the various design speeds on the main highway, 30 km/h on the side road and the right-of-way widths on both roads, see Figure E3-3.

The foregoing is based on the 3 s time criterion for both the highway and side road approaches permitting vehicles on both roads to adjust speeds in avoiding a collision.

Visibility triangle dimensions for skewed intersections for two-lane and four-lane highways have to be determined by the designer using the same principles that were employed for a 90° intersection angle.

The stop control condition is divided into two categories, namely, two-way stop and four-way stop control.

This section describes the controls as applied to two-way stop controls and may be justified under any one of several conditions as follows:

- at an intersection of a county road, local road, or township road with a provincial highway;
- intersection of an arterial with a collector or an arterial with a local unless other factors such as volume, accidents or delay dictate a higher type device (four-way stop control or traffic control signals);
- an accident experience of three or more right angle accidents per year over a period of three years, where less restrictive measures have not been effective;
- a total AADT in the range of 1500 to 8000 may be an indication of the need for two-way stop sign control. This is above the volume range where yield signs may operate satisfactorily and may be below the minimum of the volume ranges required for four-way stop control or traffic signal control. If an AADT volume in excess of 1500 vehicles is evident at the intersection of two local roads, the road classification plan should be re-evaluated.

E.3.2.3.1 Crossing Movement

Upon stopping at the stop block a driver on the side road must have sufficient sight distance to approaching vehicles on the main highway for a safe departure and crossing of the intersection from the stopped position. The sight line is based on the time it takes for the stopped vehicle to clear the intersection and the distance 'd_a' that a vehicle will travel along the main highway in that time. The distance 'd_a' may be calculated from the equation:

$$d_a = \frac{v}{3.6}(t_p + t_a)$$

v = Operational speed, km/h, of the vehicle on the main highway.

t_p = Perception-reaction time, of the driver of the stopped vehicle, 2 s assumed.

t_a = Acceleration time in seconds required for the stopped vehicle to start, accelerate and clear the intersection for a total distance S = D + W + L. See Figure E3-2.

The value of 't_a' can be read directly from Figure E3-4 for a given distance 'S' in metres for level conditions.

For a direct crossing of the intersection, the distance 'd_a' may be taken directly from Figure E3-5.

Figure E3-5 indicates the different sight distance requirements for passenger cars and trucks. A WB-15 design vehicle takes almost twice as long to pass through an intersection as a 'P' design vehicle. Design vehicles are defined in Sub-Chapter E.5.

E.3.2.3.2 Turning Movements

Upon stopping at the stop block a driver on the side road must have sufficient sight distance to approaching vehicles on the main highway for a safe departure and for turning onto the main highway. The sight distance required for a left turning vehicle must provide sufficient time for the turning vehicle to attain the assumed operating speed of the highway before being overtaken by an approaching vehicle travelling in the same direction at the design speed. Figure E3-6 indicates the sight distance requirements for stopping, crossing and turning movements for passenger vehicles on two-lane highways.

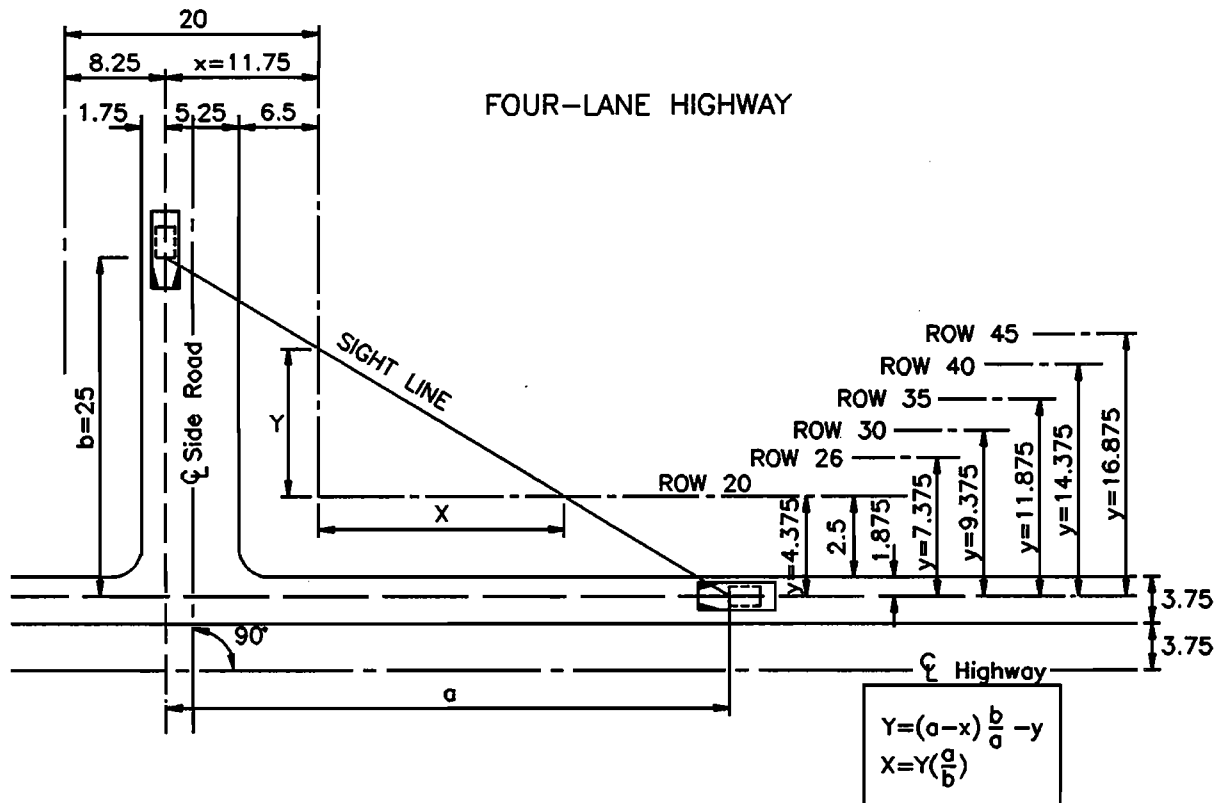
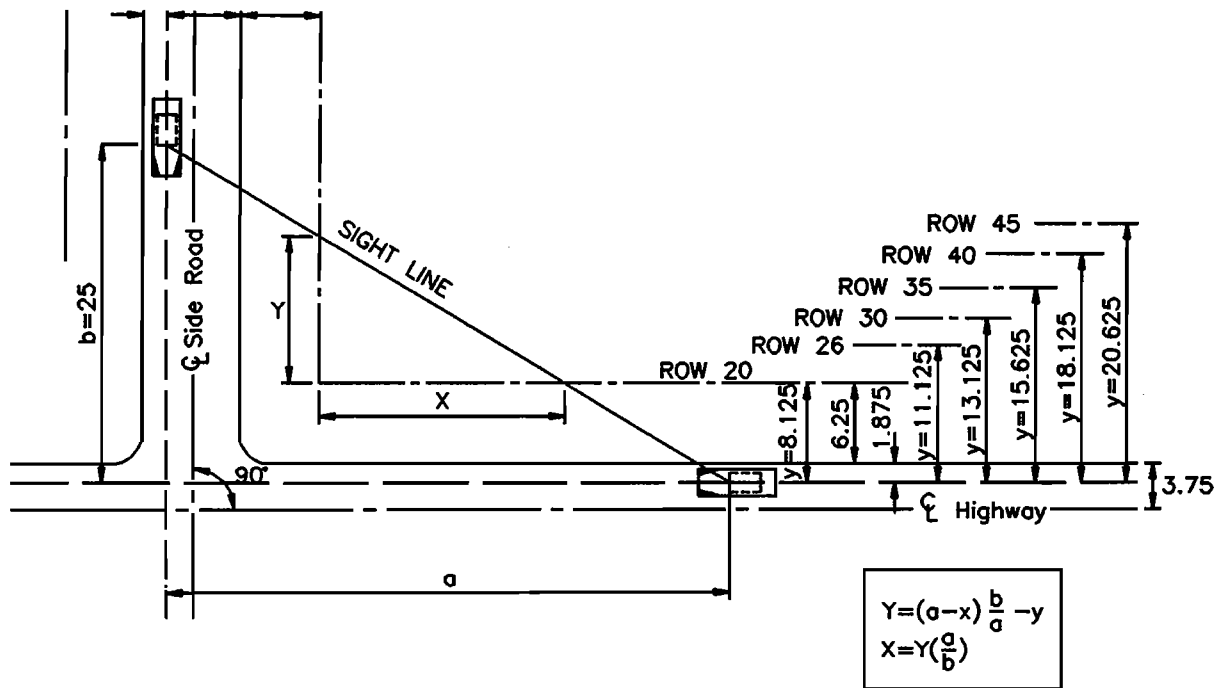

Figure E3-3
Sight Distance and Visibility Triangle at 90° Intersections
for Approaches with Stop Control

Two-lane Highway

Design speed on Highway	Approach Distance 'a' based on 3 s	Visibility Triangle: X & Y											
		Highway Right of Way (m)											
		20		26		30		35		40		45	
km/h	m	X	Y	X	Y	X	Y	X	Y	X	Y	X	Y
40	30	8	7	5	4	2	2	-	-	-	-	-	-
50	40	15	10	10	7	7	5	3	2	-	-	-	-
60	50	22	11	16	8	12	6	7	4	2	1	-	-
70	60	29	12	22	9	17	7	11	5	5	2	-	-
80	65	32	12	24	9	19	7	13	5	6	2	-	-
90	75	39	14	30	10	24	8	17	6	9	3	2	1
100	85	46	14	36	10	29	8	20	6	12	3	3	1
110	95	53	14	41	11	34	9	24	6	15	4	5	1

Four-lane Highway

Design speed on Highway	Approach Distance 'a' based on 3 s	Visibility Triangle: X & Y											
		Highway Right of Way (m)											
		20		26		30		35		40		45	
km/h	m	X	Y	X	Y	X	Y	X	Y	X	Y	X	Y
40	30	13	11	9	8	7	6	4	3	1	1	-	-
50	40	21	13	16	10	13	8	9	6	5	3	1	1
60	50	29	15	23	12	19	10	14	7	9	5	4	2
70	60	38	16	30	13	26	11	20	8	14	6	8	3
80	65	42	16	34	13	29	11	22	9	16	6	9	4
90	75	50	17	41	14	35	12	27	9	20	7	12	4
100	85	58	17	48	14	41	12	33	10	24	7	16	5
110	95	66	17	55	14	47	12	38	10	28	7	19	5

Table E3-3

Minimum Property Requirements at 90° Intersections for Approaches with Stop Control

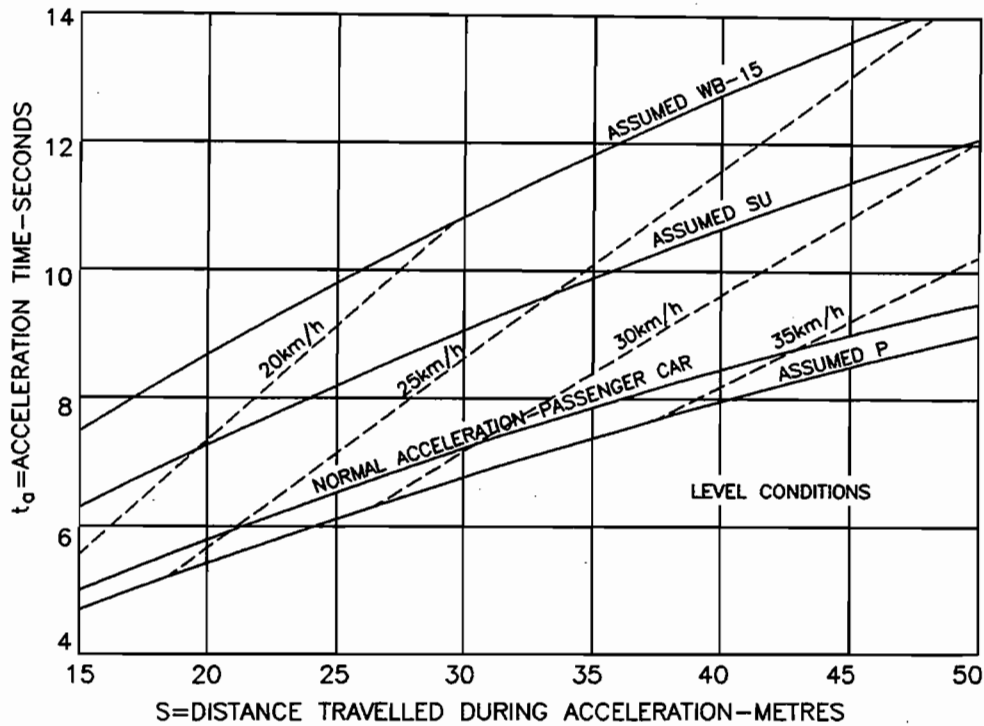

Figure E3-4

Stop Control on Side Road—Acceleration from Stop

The requirements for the right turn would be somewhat less than for the left turn. Requirements for trucks making left or right turns would be substantially greater than for passenger vehicles.

It is a basic requirement for all signal controlled intersections that drivers must be able to see the control device soon enough to perform the action it indicates. For this requirement the signal head must be clearly visible for a distance as shown in Table E3-4

E.3.2.4 Signal Control

Intersections controlled by traffic signals presumably do not require sight distance between intersecting traffic flows because the flows move at separate times. However it is desirable to provide drivers with some view of the intersecting approaches in case a crossing vehicle should violate the signal indication. A time of 3 s is provided to allow vehicles on the side road and the highway to adjust their speeds in avoiding a collision while continuing through the intersection. The sight distance requirements for signal controlled intersections is the same as for stop control; see Table E3-2, minimum distance travelled in 3 s.

Speed km/h	50	60	80	100	110
Distance m	100	120	165	215	275

**Table E3-4
Minimum Distance to Signal Heads***

At a signalized intersection of two highways the 3 s criterion with corresponding design speeds applies to all approaches. The side road approach speed as noted in the stop control does not apply.

The sight distance for right turn movements on the red phase of a signal controlled intersection is the same as for stop control.

* Manual of Uniform Traffic Control Devices, February 1982. B.5.02, DISTANCE VISIBILITY.

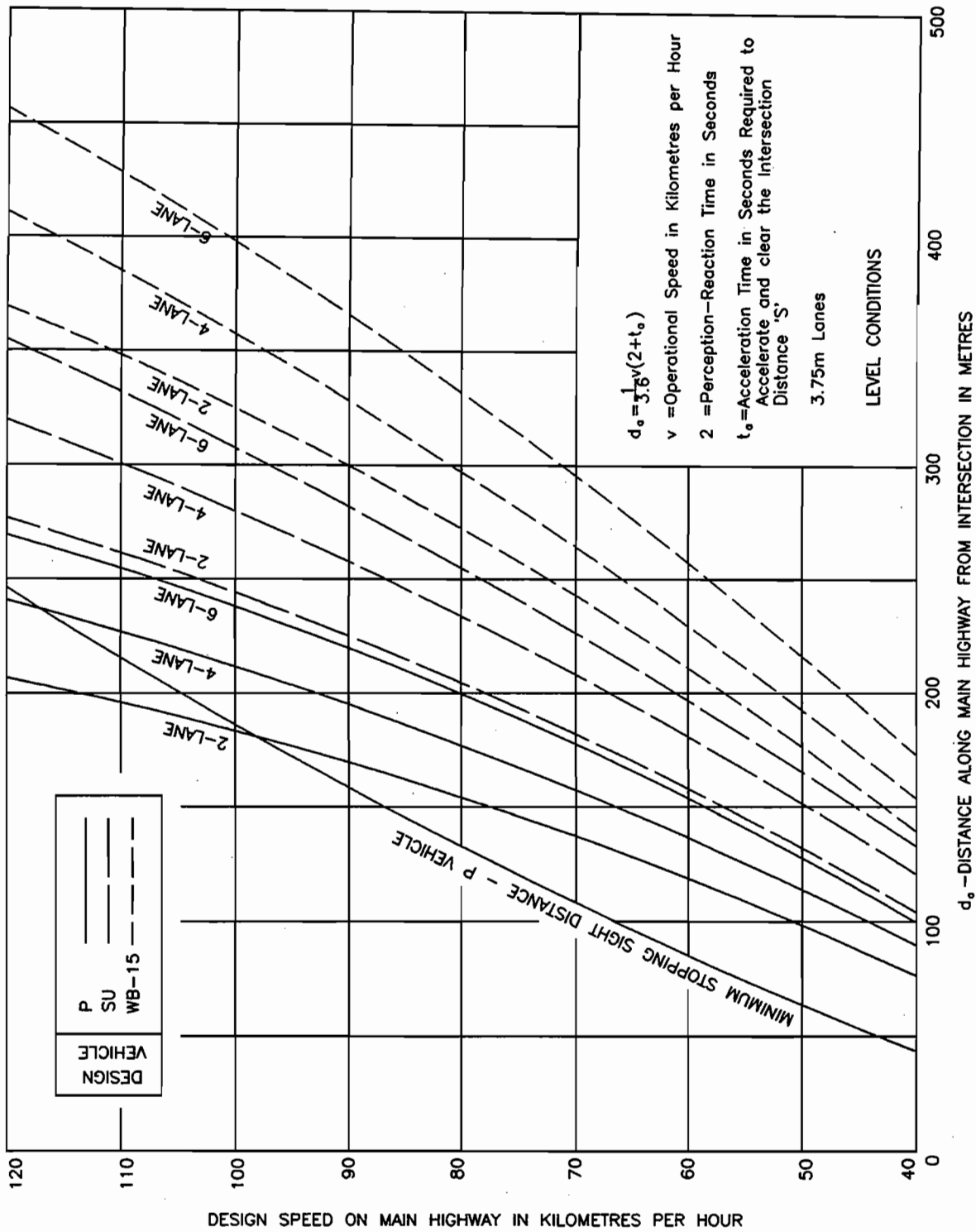

Figure E3-5
Sight Distance Requirements for Crossing Movements from Stop Condition

- A - Minimum Stopping Sight Distance, Table E3-1.
- A₁ - Distance travelled in 3 s, Table E3-2.
- B - Safe Sight Distance for P vehicle, crossing 2-lane highway from stop.
- C - Safe Sight Distance for P vehicle, turning left into 2-lane highway across P vehicle approaching from left.
- D - Safe Sight Distance for P vehicle to turn left into 2-lane highway and attain assumed operating speed before being overtaken by P vehicle approaching in same direction at design speed.
- E - Safe Sight Distance for P vehicle to turn right into 2-lane highway and attain assumed operating speed before being overtaken by P vehicle approaching in same direction at design speed.

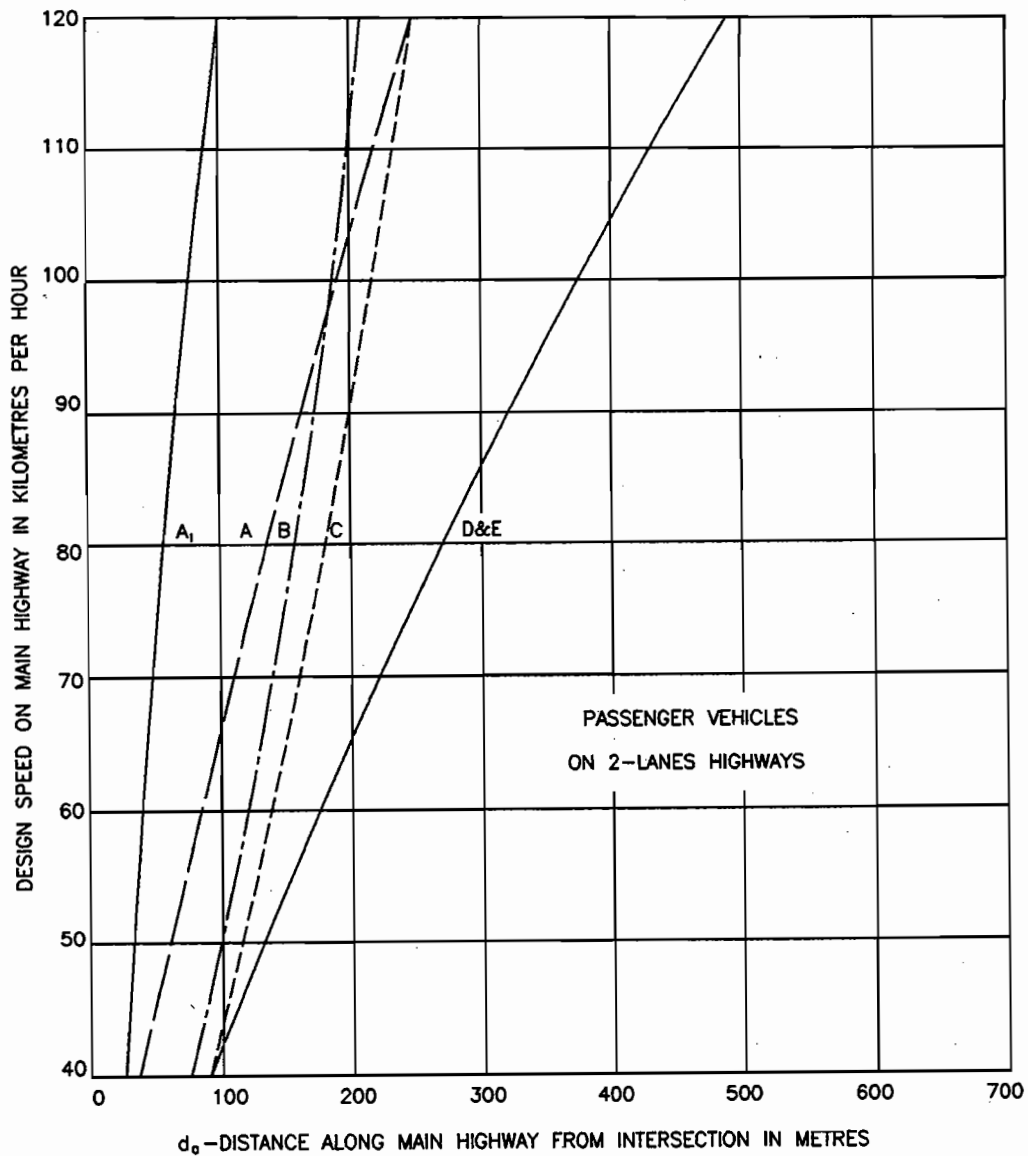

Figure E3-6

Sight Distance Requirements for Stopping
Crossing and Turning Movements

E.3.2.5 Summary of Design Requirements for Sight Distance at Intersections

The design requirements for sight distance at intersections relating to passenger vehicle dimensions and the four cases: no control, yield control, stop control and signal control are outlined in Figure E3-7.

E.3.4 DECISION SIGHT DISTANCE

Minimum stopping sight distance values generally suffice to allow the drivers to bring the vehicle to a stop, however, these distances are often inadequate when drivers must make instantaneous decisions, where information is difficult to perceive, interpret or unexpected manoeuvres are required.

Drivers may require longer sight distances at critical locations, such as intersections where sources of information compete or where the intersection is on or beyond a crest of a vertical curve, or where there is substantial horizontal curvature on the approach to the intersection area.

The decision sight distances provide designers with values for appropriate sight distance at critical locations and serve as criteria in evaluating the suitability of the sight lengths at these locations. If it is not feasible to provide these distances because of horizontal or vertical curvature, special attention should be given to the use of traffic control devices for providing advance warning of the conditions to be encountered.

A range of decision sight distance values has been developed, see Figure E3-8. The range recognizes the variation in complexity that may exist at various sites.

Decision sight distance is based on pre-manoeuve and manoeuvre times converted into distance and verified empirically. Pre-manoeuve time is the time require for a driver to process information relative to a hazard. It consists of:

- (1) detection and recognition,
- (2) decision and response initiation times.

Manoeuvre time is the time to accomplish a vehicle manoeuvre. For design purposes the calculated values are rounded.

POLICY

FOR MEASURING DECISION SIGHT DISTANCE, THE HEIGHT OF EYE OF 1.05 M SHOULD BE USED AND THE HEIGHT OF OBJECT OF 0.38 M WHICH IS THE LEGISLATED MINIMUM HEIGHT OF TAILLIGHT.

For some locations, depending on the anticipated prevailing conditions, the height of object may be the road surface, in which case the object height is zero.

3.5 SIGHT DISTANCE AT A STRUCTURE

Where a structure is located close to an at-grade intersection, adequate sight distance should be provided past the handrail of the structure between the vehicle on the main highway and a vehicle standing on the side road.

3.5.1 Sight Distance for Minor Side Road and Highway Entrance

The sight line for a minor side road or highway entrance is determined from the centre of the lane of the approaching vehicle, clearing the handrail at the distance 'A' and is extended to the back of the car 9 m from the edge of pavement on the side road or entrance. The established sight line should correspond to the minimum stopping sight distance or better, see Figure E3-9.

In restricted right-of-way conditions where the minor side road must be located closer to the structure, the required sightline could be measured to a reduced 'B' dimension. The absolute minimum for this condition is the position of the driver's eye at 5 m from the edge of pavement.

3.5.2 Sight Distance at Interchange Ramp Terminals

At interchange ramp terminals the geometric features and operational characteristics are that of an at-grade intersection. Consequently all design elements of the at-grade intersection apply with particular emphasis to the sight distance requirements.

For the sight distance design, see Sub-Section E.3.2.3.2, Turning Movements; and the adjustments for grade must be applied as outlined in Chapter C, Sub-Section C.2.3.5.

Intersecting Road	Intersection Traffic Controls - Approaches			
	No Control	Yield Control	Stop Control	Signal Control
Side Road	<p><u>Desirable</u> Minimum Stopping Sight Distance</p> <p><u>Minimum</u> Distance travelled in 3 s at Design Speed</p>	<p>Minimum Stopping Sight Distance</p> <p>a) Urban - 20 km/h b) Rural - 30 or 40 km/h</p>	<p>25 m = Distance travelled in 3 s at 30 km/h Design Speed</p>	<p>25 m = Distance travelled in 3 s at 30 km/h Design Speed</p>
Highway	<p><u>Desirable</u> Minimum Stopping Sight Distance</p> <p><u>Minimum</u> Distance travelled in 3 s at Design Speed</p>	<p>Minimum Stopping Sight Distance for the Design Speed</p>	<p>Distance travelled in 3 s at Design Speed</p>	<p>Distance travelled in 3 s at Design Speed</p>

Intersecting Road	Intersection Traffic Controls - Departures			
	No Control	Yield Control	Stop Control	Signal Control
Side Road	<p>Stop Control applies</p>	<p>Stop Control applies</p>	<p>Stop Control applies</p>	<p>Stop Control for Right Turns</p>
Highway	<p>Stop Control applies</p>	<p>Unrestricted Open Highway Condition applies</p>		<p>Stop Control for Right Turns</p>

Figure E3-7
Design Requirements for Sight Distances at Intersections

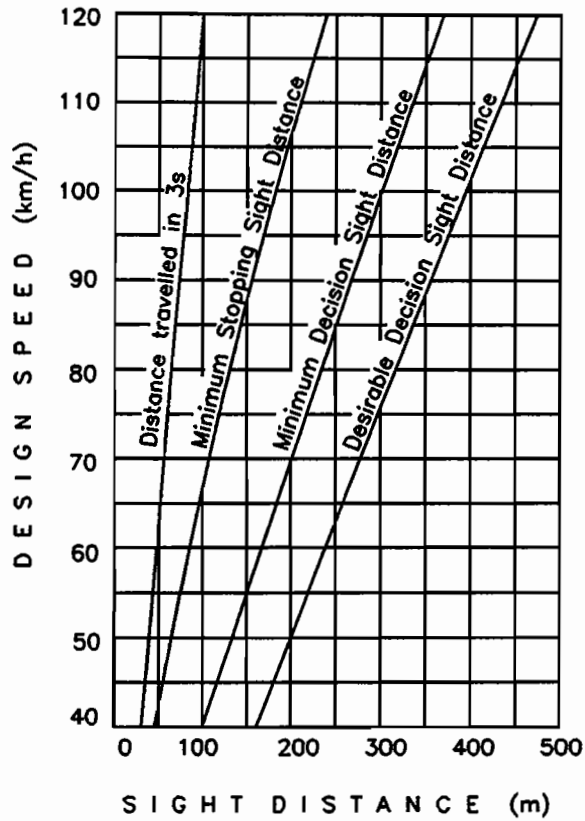

Figure E3-8
Decision Sight Distance for Critical Locations

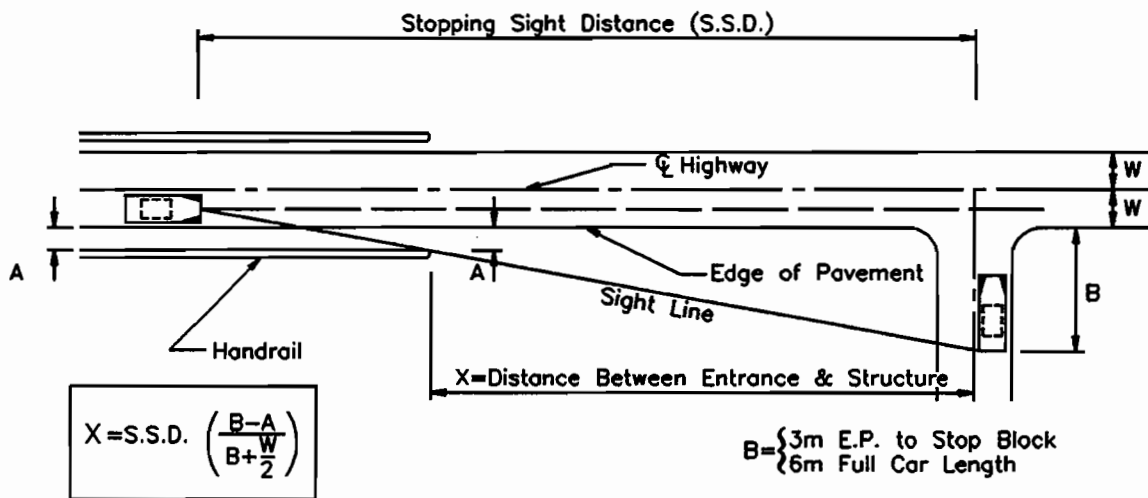

Figure E3-9
Sight Distance at a Structure

E.3.6 SIGHT DISTANCE AT RAILWAY CROSSINGS**(I) Rural environment****POLICY**

SIGHT DISTANCE IS A PRIMARY CONSIDERATION AT RAILWAY CROSSINGS. THE DESIRABLE SIGHT TRIANGLE IS SUCH THAT A DRIVER APPROACHING THE GRADE CROSSING IS ABLE TO SEE A TRAIN AT A DISTANCE THAT, IF IT PROCEEDED WITHOUT SLOWING DOWN, WOULD REACH THE CROSSING AT THE SAME TIME THE HIGHWAY VEHICLE CAN BE BROUGHT TO A STOP IN ADVANCE OF THE CROSSING.

To satisfy this condition, two sides of the minimum sight triangle are:

- a distance along the highway, measured from the stop line at the crossing, corresponding to the minimum stopping sight distance for the design speed of the highway, shown in Table E3-1 and

- a distance along the track, measured from the edge of pavement, equivalent to the distance travelled by the train during the time interval required for the highway vehicle to be brought to a stop. The sight line for this condition can be derived from Table E3-5.

The position of the sight line is established by determining the approach distance on the highway, d_a , and the approach distance on the railway track, d_b see Figure E3-10.

In some locations, it might be necessary to rely on speed control signs and other warning devices, and to predicate sight distance on a reduced vehicle speed.

(ii) Urban environment

No sight obstruction of any kind, including commercial signs, should be permitted near a railway grade crossing for a distance of 100 m. The safety warning devices associated with such crossings should be clearly visible.

Guidelines for horizontal and vertical alignment restrictions and additional elements of design are outlined in Section E.12.

**Table E3-5
Sight Distance Requirements for Railway Crossings**

Train Speed (km/h)	Vehicle Design Speed (km/h)					
	Vehicle Departure from Stop Line	Moving Vehicle				
		0	60	70	80	90
	Distance Along Railroad from Crossing, d_b (m)					
30	150	70	80	90	90	100
80	405	180	210	230	240	250
100	505	230	260	280	300	320
150	755	350	390	420	460	480
Distance Along Highway from Crossing, d_a (m)						
		90	115	140	165	190

Note: Adjustment for grade must be applied as outlined in Chapter C, Sub-Section C.2.3.5

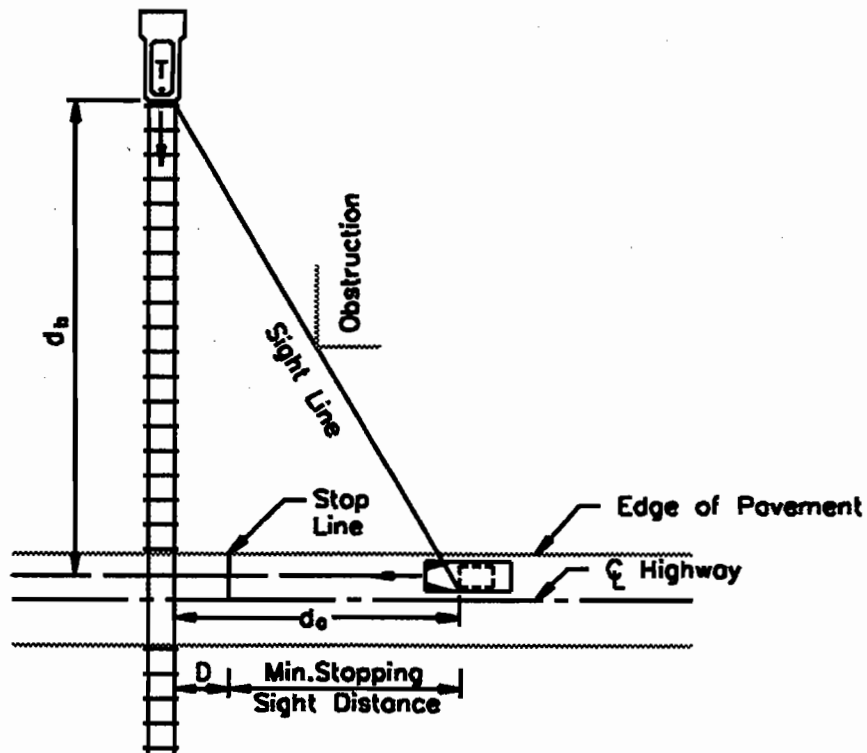

**$D=4.5\text{m}$; Stop Block
Set-Back Distance**

**Figure E3-10
Sight Distance at Railway Crossings**

E.4 INTERSECTION GEOMETRIC CONTROLS

This section covers the following geometric design features:

- . horizontal alignment,
- . vertical alignment and
- . cross-sections.

Coordination of all three design aspects is essential. Careful consideration should be given to the combination of horizontal and vertical alignment. A sharp horizontal curve following a crest vertical curve is very undesirable in the intersection area. Horizontal and vertical alignment should provide for a safe and continuous operation. At intersections the site conditions generally establish definite alignment limitations on intersecting roads. It is usually possible to modify an alignment, however, and thereby improve traffic conditions and reduce hazards, particularly on rural highways. On vertical alignments at intersections, composition of grade lines that make vehicle control difficult should be avoided. It is desirable to avoid substantial grade changes, but it is not always feasible to do so. Adequate sight distance should be provided along the roadways and across the corners, particularly where one or both intersecting roadways are on vertical curves.

E.4.1 HORIZONTAL ALIGNMENT

Where practicable, it is preferable to have the highway alignment and side road alignment on tangent through the intersection area, see Figure E4-1. If curves are unavoidable, a curve with 1200 m radius, or larger, should be used where speeds are 80 km/h or more, and a minimum radius of 300 m (600 m radius is preferred) where speeds are under 80 km/h. Wherever possible the flattest practical highway horizontal curve should be used through intersections resulting in the

application of lower superelevation rates. Approach alignment should be such as to provide better than minimum stopping sight distance for each road; for details see Chapter C, Alignment.

At a skewed 'T' intersection with an angle less than 70° certain undesirable conditions exist because of the flat angle of entry, drivers are encouraged to disobey the control device and enter the highway without stopping. Vehicles which do stop are standing in a position that affords poor visibility for judging the speed and the distance of approaching vehicles on the highway. Also vehicles leaving the highway to enter the side road, because of the flat angle, are encouraged to do so at high speeds and tend to cut the corner thereby travelling in the opposing lane for a considerable distance. See Figure E4-2, condition (a).

In a case of an intersection with sharp curvature as shown on Figure E4-2, condition (b), an undesirable condition exists since drivers on the side road approaching the highway at relatively high speeds could go out of control on the tight curve, or, if they negotiate the curve, fail to stop in time to prevent entering the highway. The design of the intersection treatment can be improved by realigning the sideroad and providing a length of tangent (preferably 25 m long) between the turning radius and the curve of the sideroad. The length of tangent should be adequate to provide for superelevation transition, tangent runoff and braking distance. The curve should have a 45 m radius for a low speed sideroad condition and 80 m radius for a higher speed road condition with an appropriate spiral in advance of the curve. This design will control the speed of the vehicles on the sideroad as they approach the stop condition at the intersection. The revised angle of intersection may vary from 70° to 90°, see Figure E4-2, condition (c). Condition (c) is also the solution for condition (a).

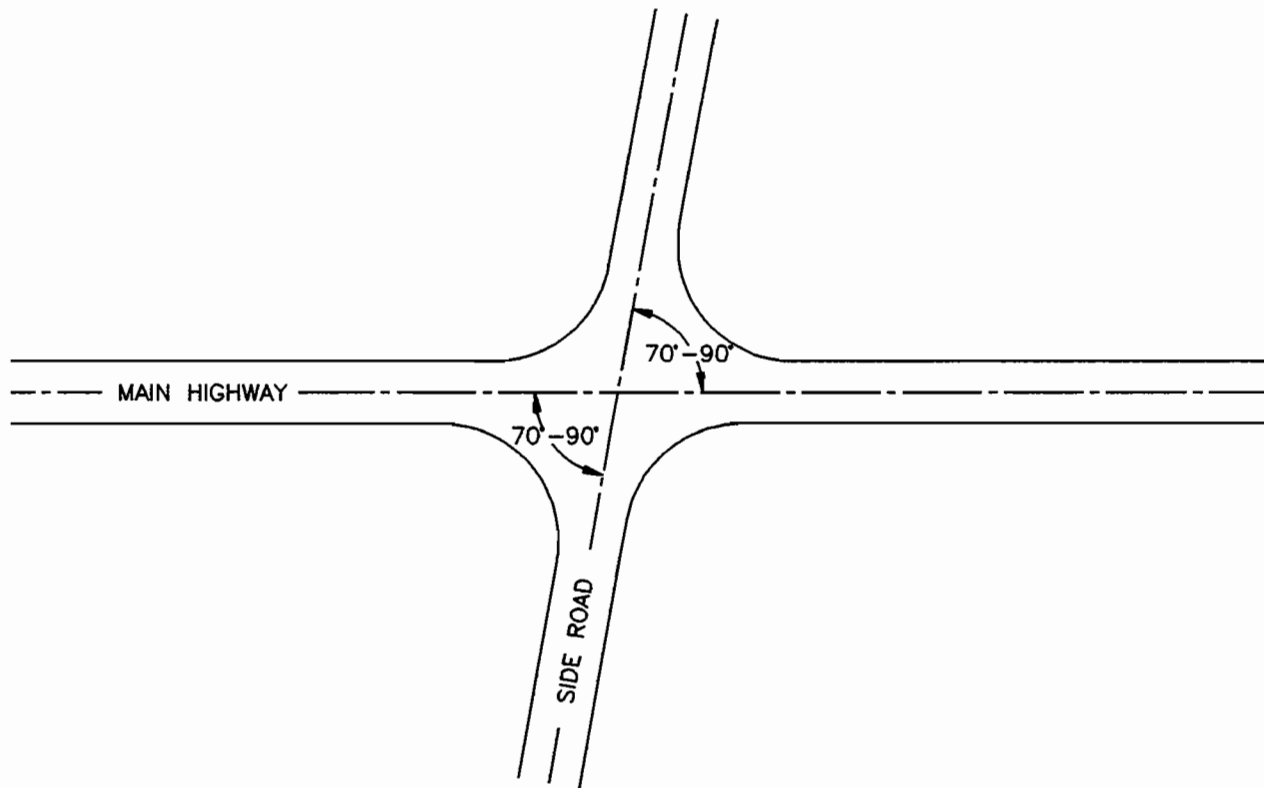

Figure E4-1
Desirable Horizontal Alignment

On any roadway where realignment takes place, the original roadway should be closed off and screened by appropriate landscaping and shrubbery. Similarly at a skewed cross intersection with an angle $<70^\circ$ or $>110^\circ$, the design can be improved by realigning the sideroad with 45 m radius curves adjacent to the intersection preceded by variable curves and spirals as shown in Figures E4-3 and E4-4.

In instances where a sideroad, having several kilometres of straight uninterrupted alignment, suddenly intersects a through highway, and where

there is a poor observance of the stop sign and where there is a high incidence of accidents due to drivers over-shooting the stop sign, the situation can usually be improved by placing a stop ahead sign 250 m in advance of the stop sign. The safety aspect could also be improved by introducing a curve, or series of curves, on the sideroad just before the intersection. The use of the curves here tends to alert the driver and prepare him for the highway signs and intersection ahead.

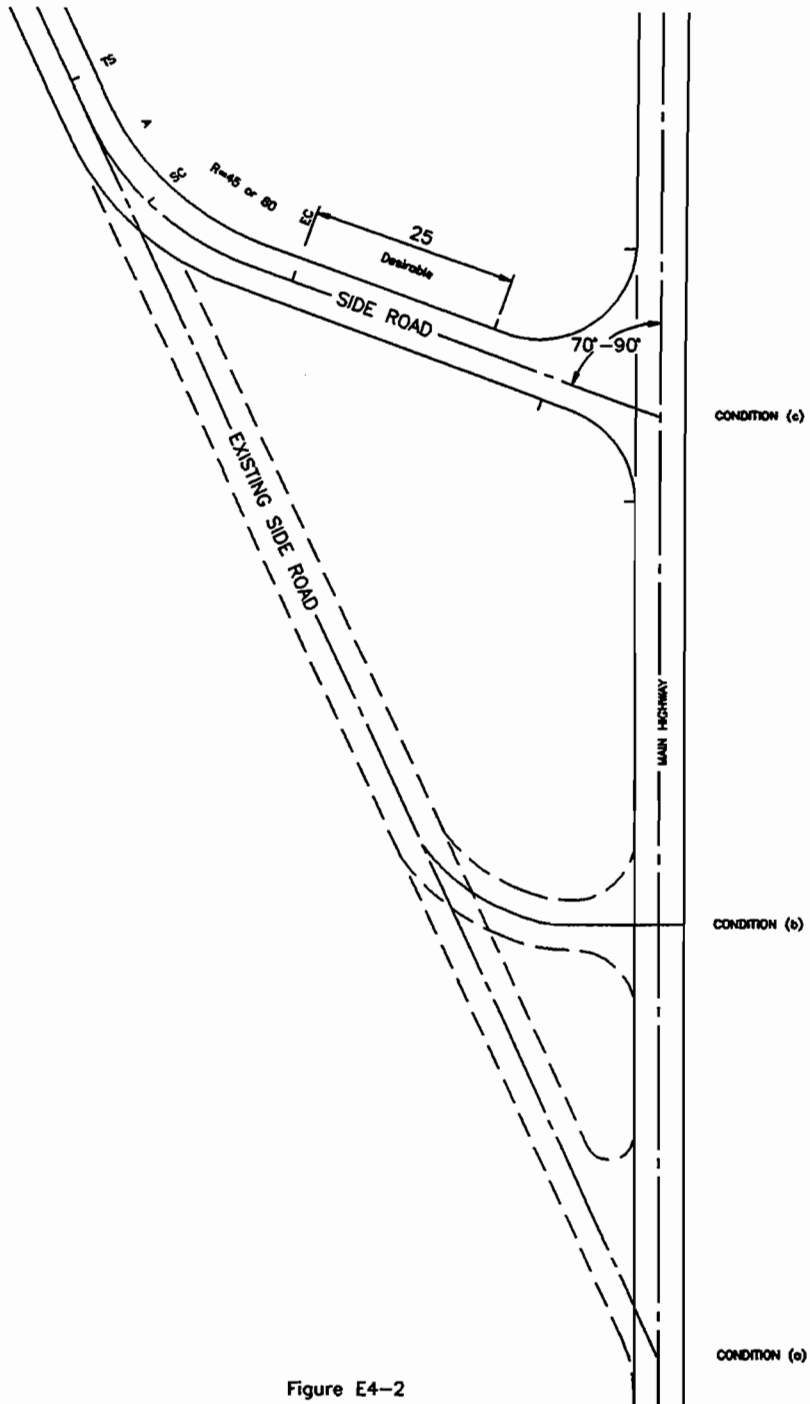

Figure E4-2

Re-Alignment of Side Road at Skewed 'T' Intersection

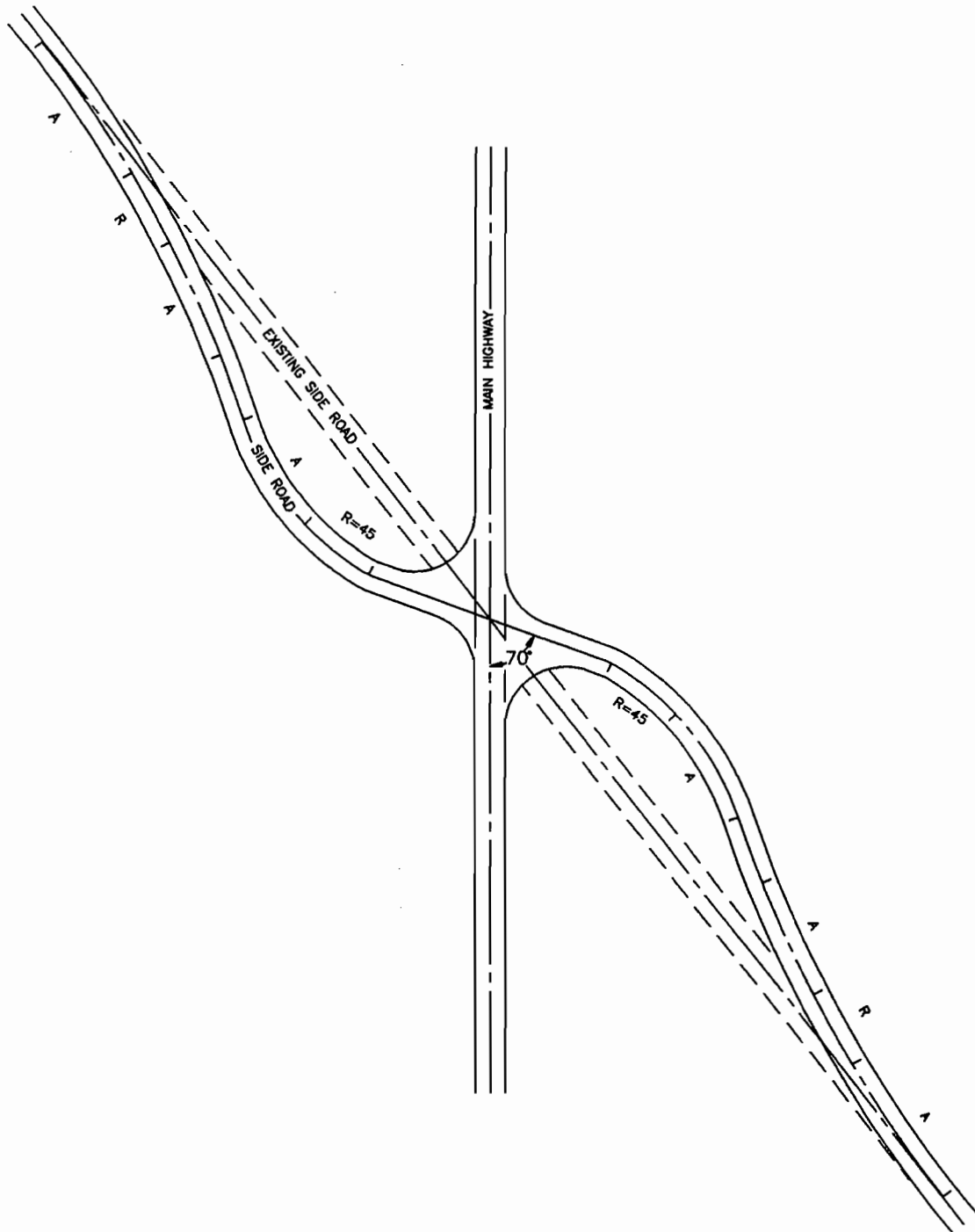

Figure E4-3
Re-Alignment of Skewed Cross-Intersection,
Point of Intersection Retained

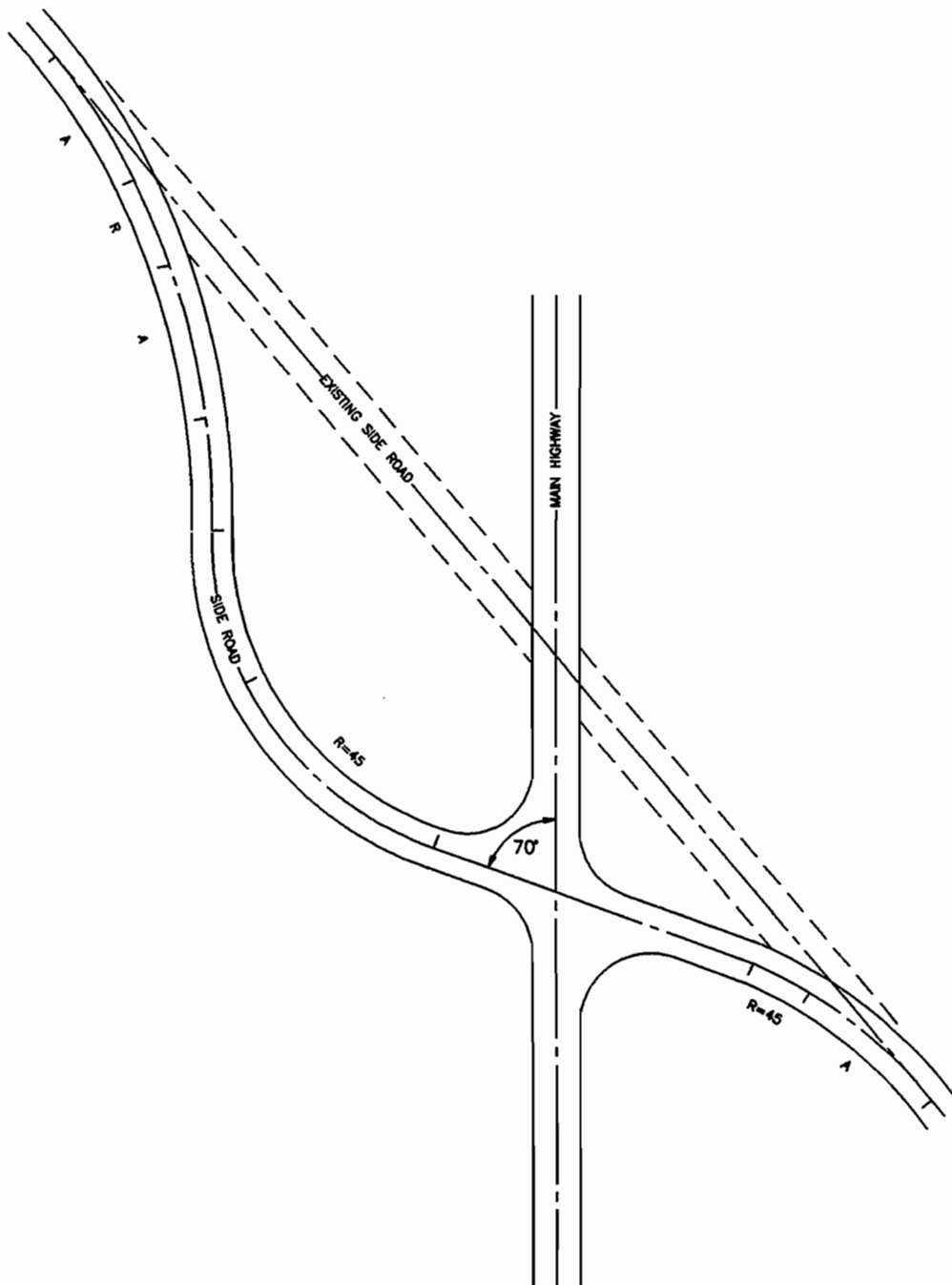

Figure E4-4
Re-Alignment of Skewed Cross-Intersection,
Point of Intersection Relocated

E.4.2 VERTICAL ALIGNMENT

Vertical curves and grades on the through highway and the intersecting road should be such as to provide better than minimum stopping sight distance for each road. The grades on both roads through the intersection should be as near level as is practicable, particularly where vehicles must stop and wait as in left turn storage lanes and on the sideroad. On the main road the grades should be from 0.15% to 3%. On the sideroad the approach grades should be between 0.5% and 2% upgrade and should extend approximately 25 m back from the edge of the highway, see Figure E4-5.

Where the sideroad grades drop rapidly on the approach to the highway, grades up to +2% are acceptable and the 25 m desirable distance can be reduced to one or two car lengths for light traffic volumes.

K factor (for definition of K factor refer to Chapter C, Alignment) of 4 minimum or other suitable values should be selected for the vertical curve depending on the terrain.

E.4.3 PAVEMENT CROSS-SECTIONS AT INTERSECTIONS

Usually, for the stop-controlled intersections, the pavement cross-section of the highway is held constant through the intersection and the sideroad is adjusted to fit; see Figure E4-6; or, the sideroad profile is retained with appropriate cross-section adjustment on both the main highway and the side road, see Figure E4-7.

Where the vertical alignment of a side road conforms to the superelevation of the cross slope of the main highway, little or no adjustment is required, see Figure E4-8.

Where the vertical alignment of a side road does not conform to the superelevation of the cross slope of the main highway, some adjustment is required, see Figure E4-9.

Where the intersecting roads are nearly equal in importance, as in the case of two highways, or at a signalized intersection, a mutual adjustment in profiles and cross-sections may be required, see Figure E4-10. In this case a 0.5% cross-fall is desirable, for both intersecting roads. Drainage may be an additional control, particularly for curbed pavements at low points.

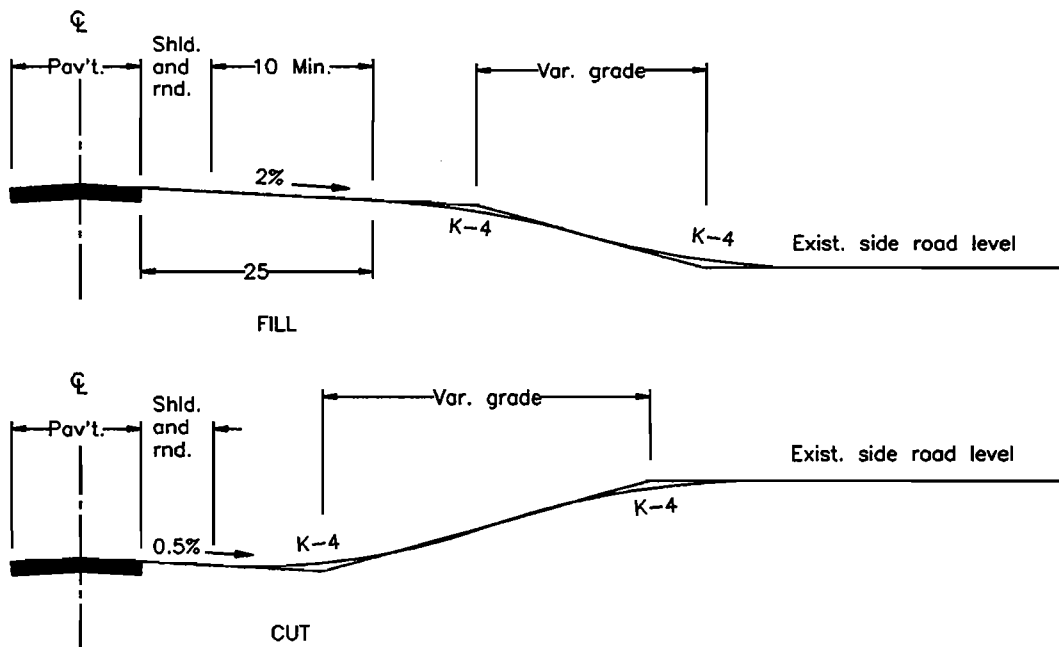

Figure E4-5
Side Road Approach Grade

AT-GRADE INTERSECTIONS

At an unsignalized intersection of two highways of nearly equal importance, usually one facility is designated to give way to the other by means of a traffic regulatory sign.

Where there is no priority to determine which traffic flow should be stopped, a thorough study should be made and the possibility of signaling the intersection in the future, analyzed.

INTERSECTION GEOMETRIC CONTROLS

If the terrain conditions are such that a "break" in cross slope is required between the edge of pavement of the main highway and the sideroad, the effect of roll-over must be taken into consideration from an operational and visual point of view. The difference should desirably be 4% and not exceed 6%, see Figure E4-11.

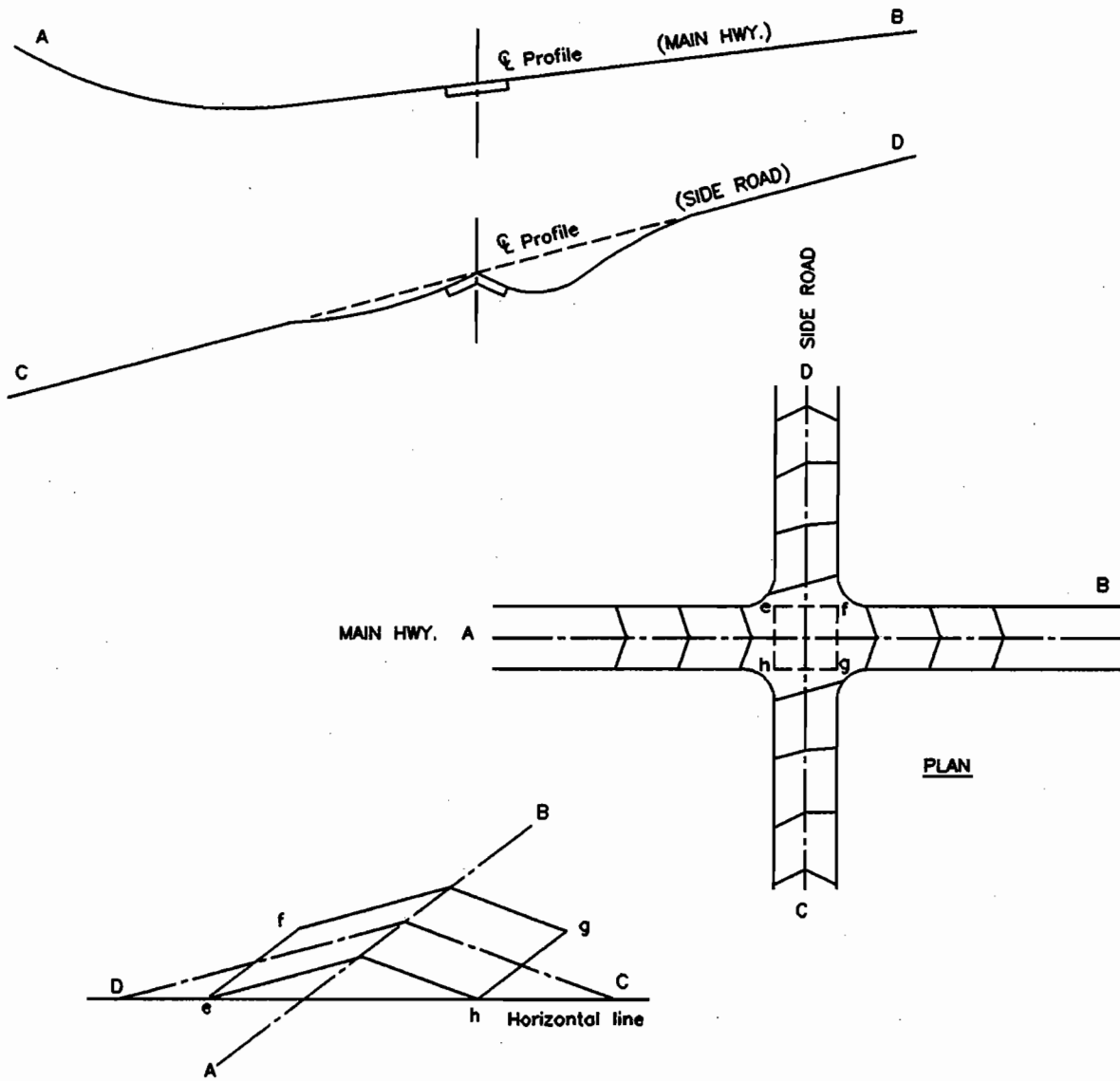

Figure E4-6

Pavement Cross Sections
Typical Side Road Profile Adjustment

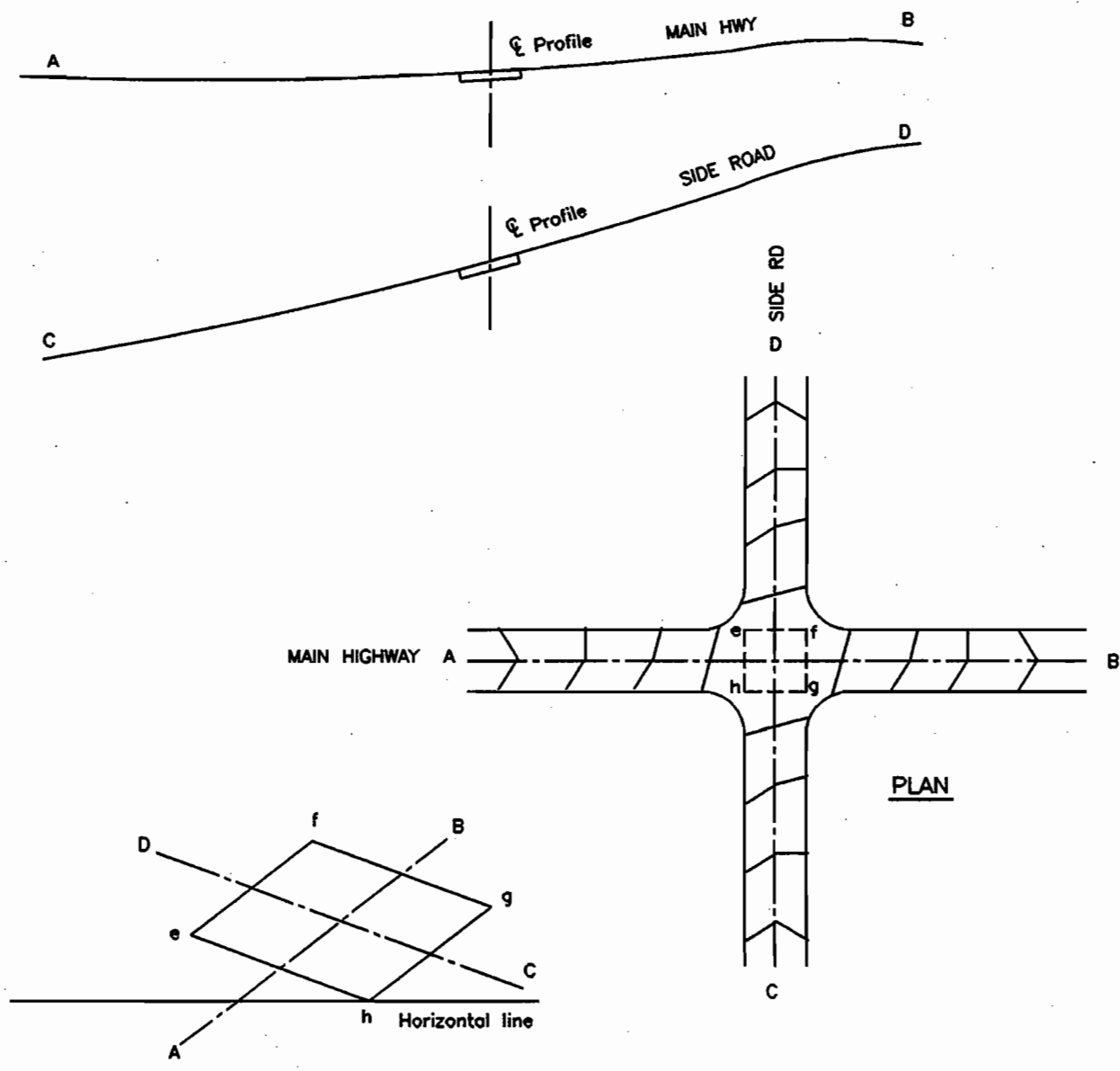

Figure E4-7

Pavement Cross Sections
Adjustment of Cross Slopes

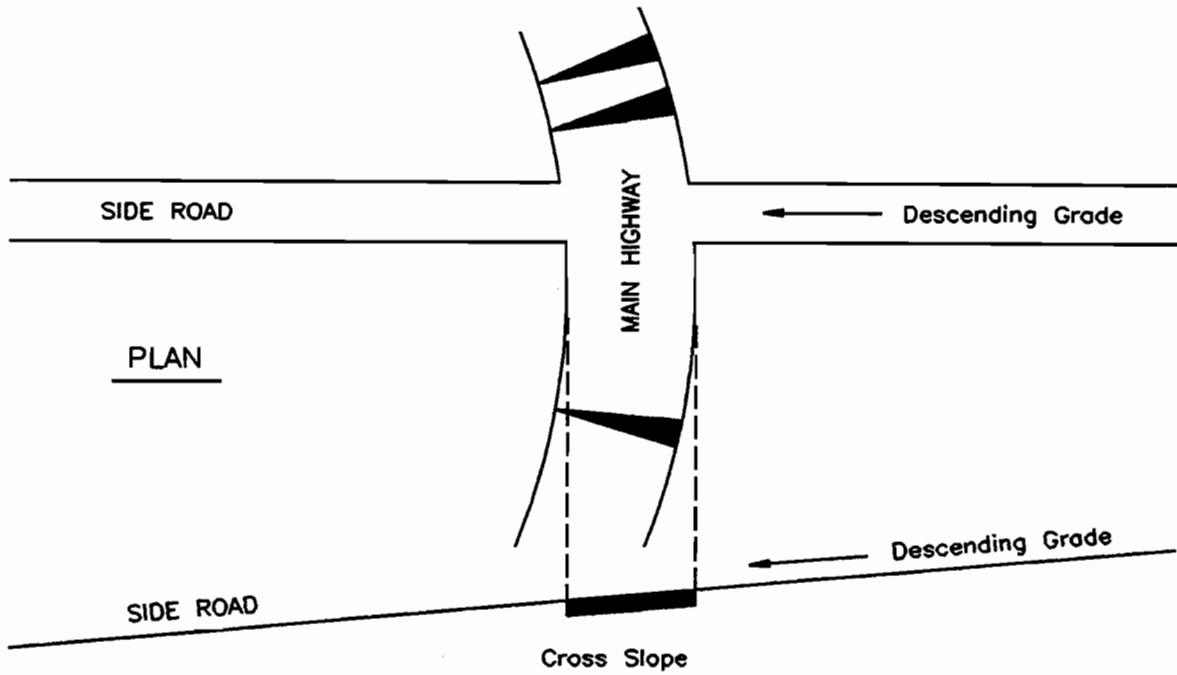

Figure E4-8
Pavement Cross Sections
No Adjustment on Side Road Profile

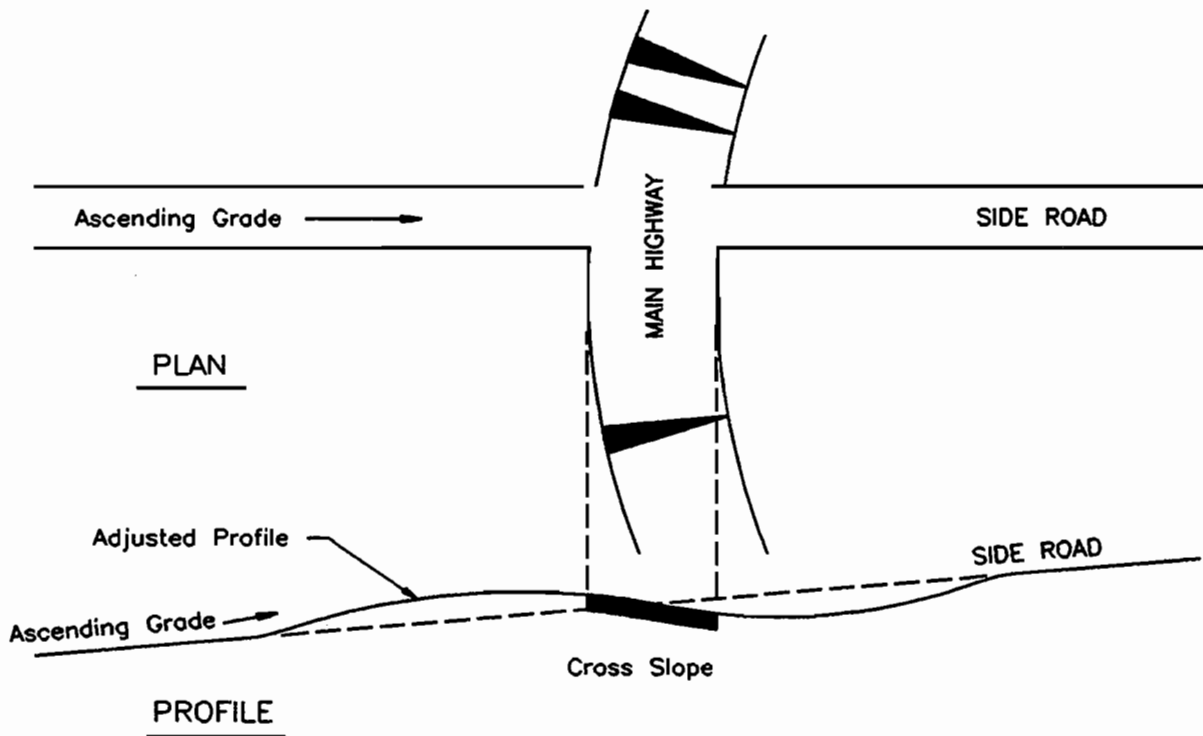

Figure E4-9
Pavement Cross Sections
Adjustment on Side Road Profile

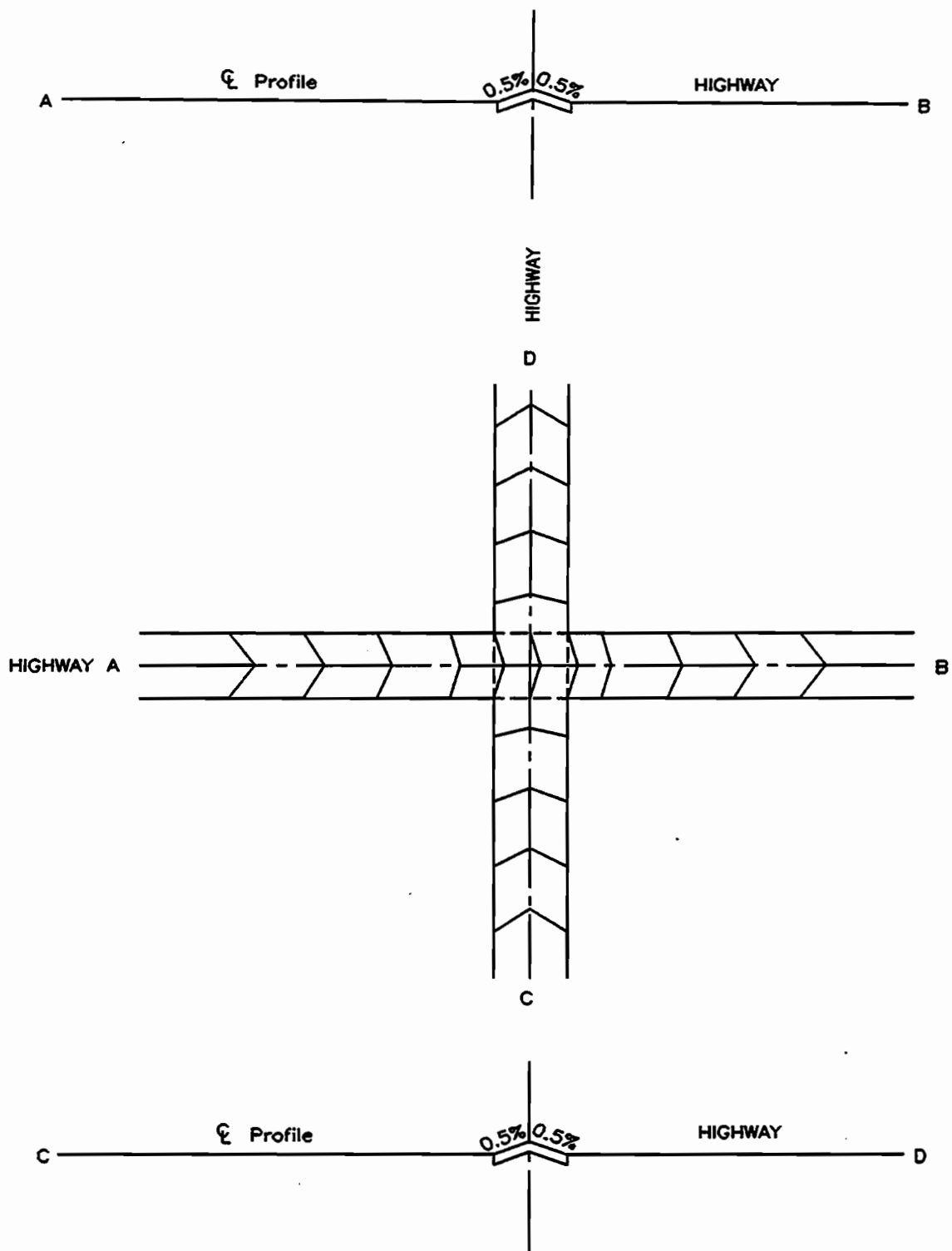

Figure E4-10

Pavement Cross Sections
Typical Adjustment of Profile and Cross Slope
at Two Main Highways

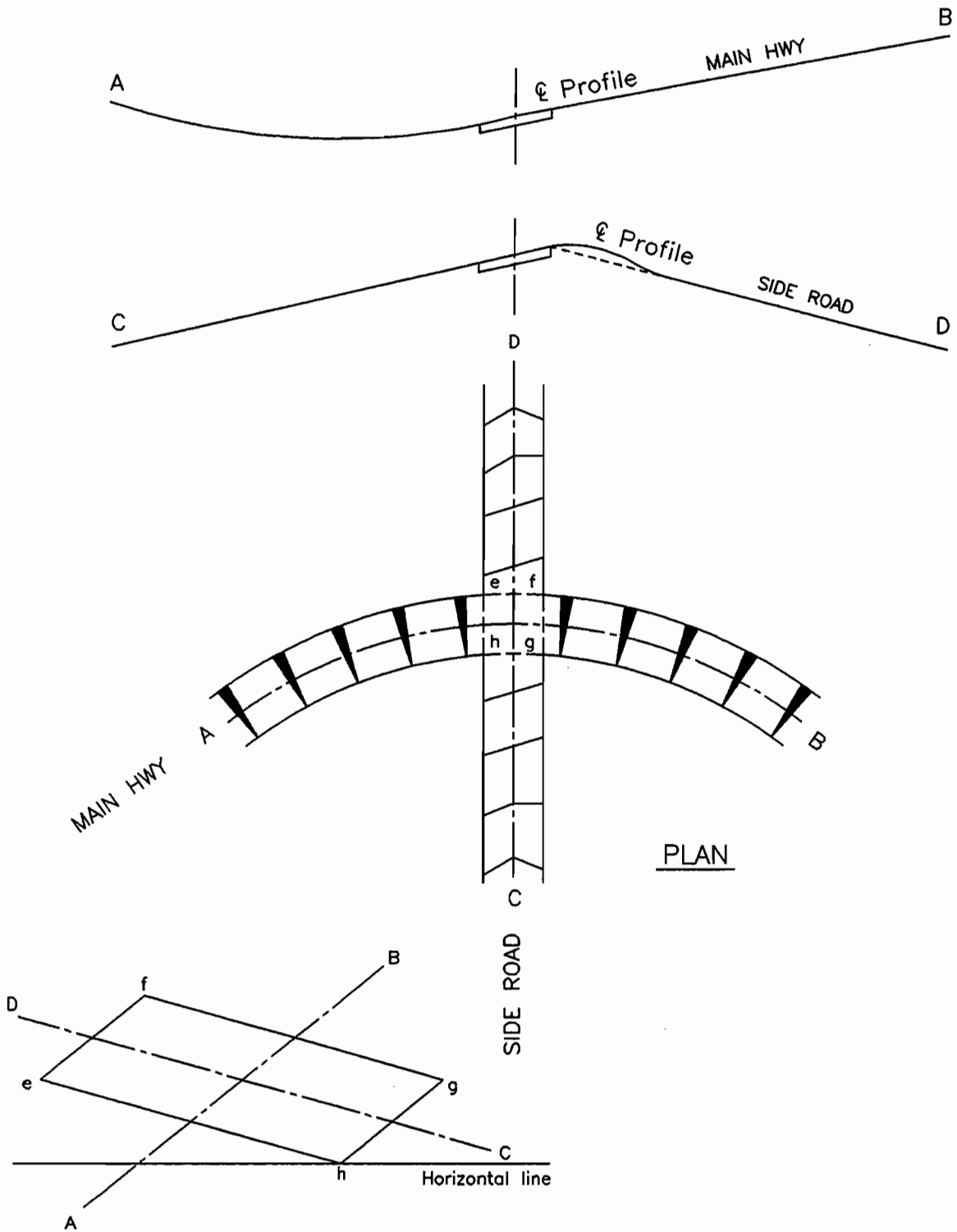

Figure E4-11

Pavement Cross Sections
Side Road Profile Adjustment

E.4.4 SHOULDERS AT OPEN THROAT INTERSECTIONS**E.4.4.1 General**

The rural roadway width at intersections includes shoulders or equivalent lateral clearance outside the edges of pavement. A shoulder at intersections is provided for the same main reasons as that for the open highways. It is an area adjacent to the driving lane where a driver can make an emergency stop for a disabled vehicle. It is also used for travel of emergency vehicles.

Due to improper vehicle operations, shoulders at intersections deteriorate at a faster rate than on open highways. Edge of pavement drop-off and gravel strewn onto the pavement are main concerns which require frequent inspection and maintenance. This section deals with shoulder treatment at intersections designed to minimize these concerns.

At intersections the required shoulder width varies from a minimum of 0.5 m to that of an open highway cross-section. Where two roadways of different operational characteristics and functions intersect, the shoulder width at intersection normally varies and serves as a transition from a wide shoulder at the main highway to a narrow one at the side road.

Where a side road intersects the main highway and forms a 'T' or cross intersection, the shoulder width is gradually reduced from that of the main highway shoulder to the shoulder width of the side road and transitioning within the length of the edge of pavement curve.

Where the main highway is designed with auxiliary lanes the shoulder width on the near side of the intersection of highway to side road exit is transitioned within the length of the edge of pavement curve.

For the far side or side road to highway entrance the shoulder width of the side road is applied along the edge of pavement curve and transitioned to the shoulder width of the highway within the 30 m recovery taper length, as shown in Figure E4-12.

A uniform intersection shoulder width is designed where the intersecting roads are nearly equal in importance and have identical shoulder width.

E.4.4.2 Shoulder Treatment At Open Throat Intersections

The shoulder treatment at open throat intersections is divided into three types:

- a. Gravel Shoulders
- b. Paved Shoulders

c. Concrete Curb and Gutter

Each type of shoulder treatment can be applied at intersections with or without tapers or deceleration lanes.

Delineators may be used in conjunction with either gravel or paved shoulder treatment at intersections. Generally, the application of delineators is discouraged as they are often damaged or destroyed by turning vehicles and their effectiveness is greatly reduced. They also cause maintenance problems during snow removal operations. However, delineators may provide a guidance to the drivers exiting and entering the highway in locations with restricted visibility and during poor weather conditions.

The shoulder treatment at intersections must be evaluated and designed for each location based on existing and anticipated future conditions and in consultation with the Regional Traffic Section and the District Office.

a. Gravel Shoulders

The shoulder treatment at intersections is usually achieved by surfacing the shoulder with gravel, see Figure E4-13. However, unstabilized shoulders generally undergo consolidation with time and the elevation of the shoulder at the pavement edge tends to become somewhat lower resulting in pavement dropoff. Also turning manoeuvres contribute to gravel spillage onto the pavement area. Regular maintenance is necessary to reduce the accident potential.

b. Paved Shoulders

At intersections, a high percentage of drivers cut across the shoulder when turning right from the through road to the side road. Also, decelerating vehicles on gravel roads, particularly abruptly stopping vehicles, drag gravel onto the paved intersection area. In order to reduce pavement edge drop-off and gravel strewn onto the pavement, the paved shoulder treatment at intersections is considered an effective design feature, see Figure E4-14.

c. Concrete Curb and Gutter

Where shoulder gravel spillage is attributed to, or is anticipated to be caused by intersection turning manoeuvres, concrete curb and gutter may be applied as shown in Figure E4-15. A mountable or semi-mountable type is preferred.

The paved shoulder with concrete curb and gutter is deemed to be the most effective design. It discourages drivers to deviate from the appropriate turning path onto the shoulder.

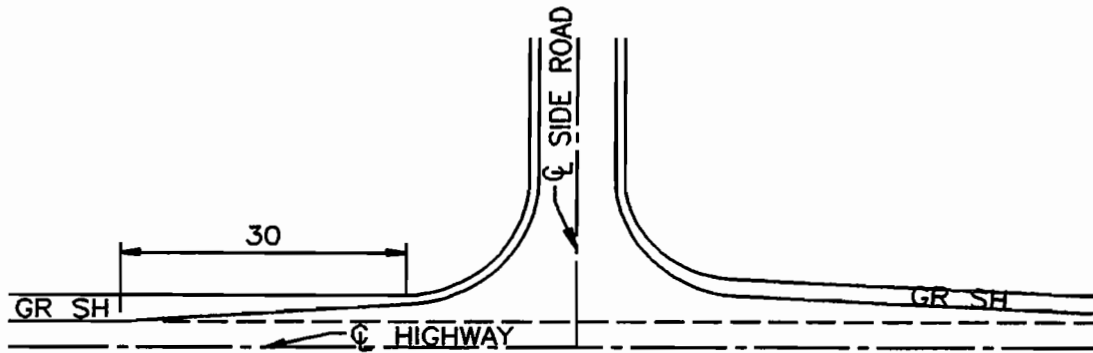

Figure E4-12

Shoulder Transition at Open Throat Intersections with Auxiliary Lanes

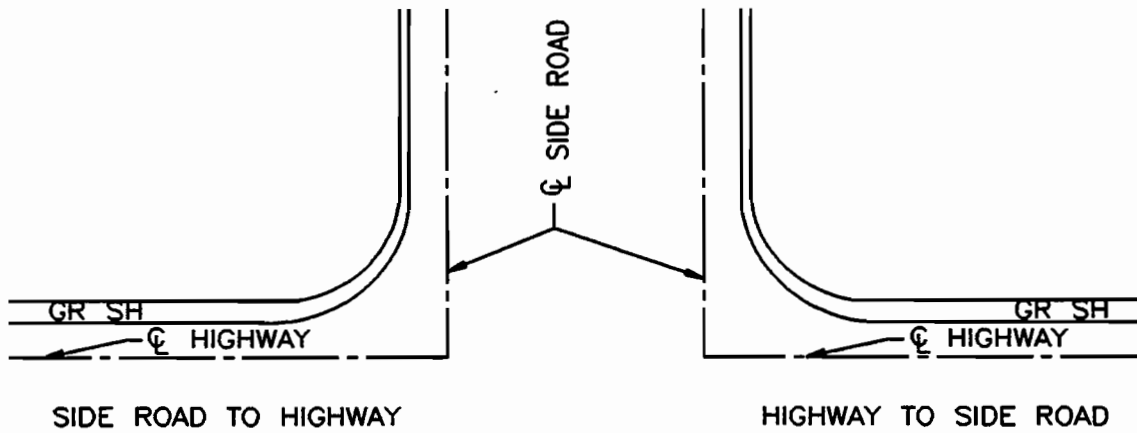

Figure E4-13

Gravel Shoulder Treatment at Simple Open Throat Intersections

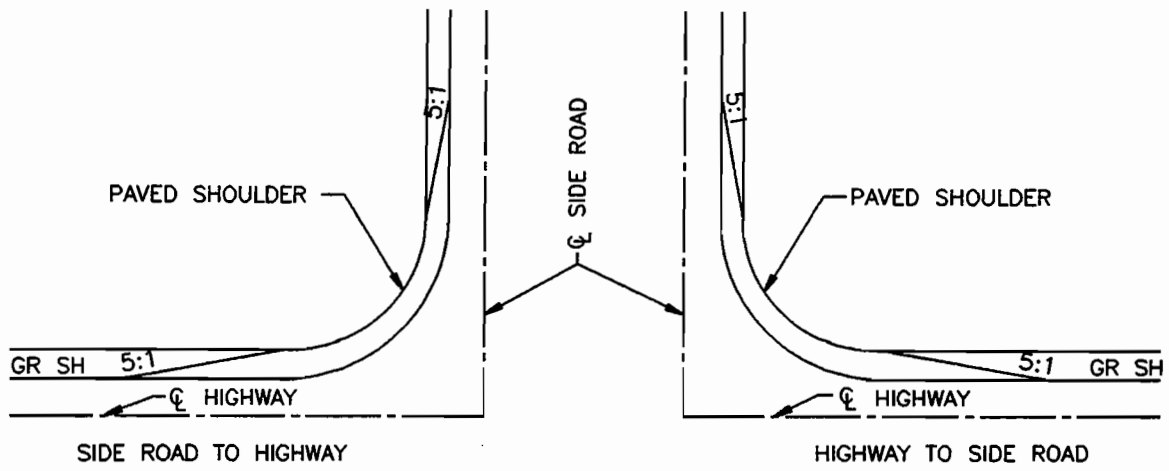

Figure E4-14

Paved Shoulder Treatment at Intersections

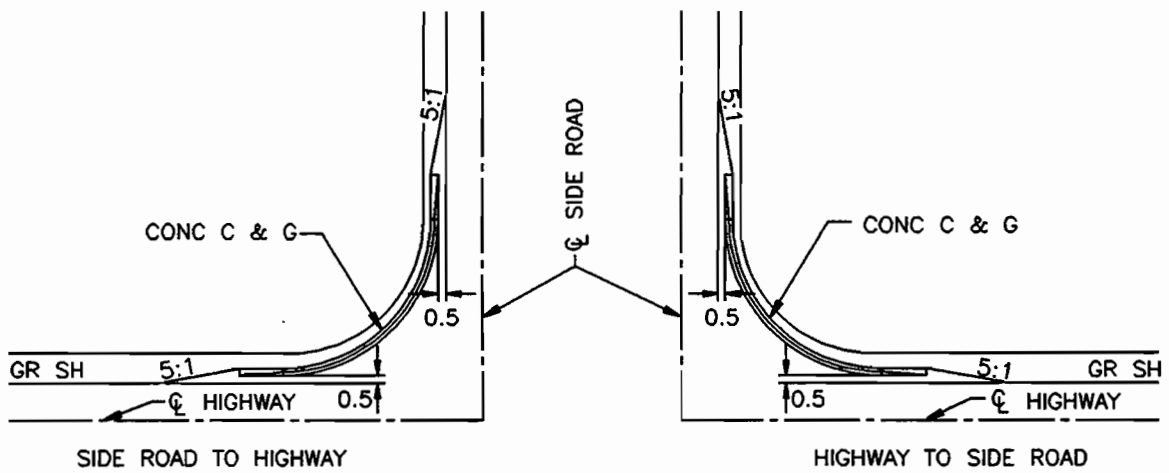

Figure E4-15

Shoulder Treatment with Concrete Curb and Gutter at Intersections

Type of Treatment	Warrants/Criteria
<ul style="list-style-type: none"> ◦ Gravel Shoulders 	<ul style="list-style-type: none"> - Lightly travelled side roads, < 200 AADT - Few commercial vehicle turns. - No recorded maintenance problems.
<ul style="list-style-type: none"> ◦ Paved Shoulders 	<ul style="list-style-type: none"> - Moderately travelled side roads, 200 - 500 AADT. - Moderate commercial vehicle turns. - Identifiable shoulder maintenance problems. - When main highway shoulders are paved, or partially paved.
<ul style="list-style-type: none"> ◦ Concrete curb and gutter; - type "A" recommended for gravel shoulders, - type "D" recommended for paved shoulders. 	<ul style="list-style-type: none"> - Heavily travelled side roads, > 500 AADT. - High volume of commercial vehicle turns. - Identifiable shoulder maintenance problems. - On side roads in fill and at signalized intersections. - At superelevated highway sections to control drainage and erosion.

Figure E4-16

Guidelines for Shoulder Treatment At Open Throat Intersections

E.5 DESIGN VEHICLES

The physical dimensions and performance characteristics of various size vehicles using the highway system form positive controls in geometric design. For this reason it is necessary to evaluate all vehicle types, select general class groupings and develop representatively sized vehicles within each class for design use. In the process a design vehicle is established and it is defined as a motor vehicle of selected dimension and operating characteristics and is a representative unit in its class or vehicle group. The design vehicle is used to establish geometric design controls for specific turning requirements and conditions for the purpose of accommodating vehicular movements of a designated type.

In the design a reasonable safety margin is always considered and therefore each design vehicle has larger dimensions and larger minimum turning radius than those of almost all vehicles in its group.

E.5.1 DESIGN VEHICLE CLASSES

The design vehicle classes and types are based on the (AASHTO) American Association of State Highway and Transportation Officials Engineering Standards, except for the WB-17.5 type which was developed by the ministry.

The three general classes of vehicles are:

- A. Passenger Cars
- B. Trucks
- C. Buses/Recreational Vehicles

A. Passenger Cars

The passenger car class includes compacts and subcompacts plus all light vehicles and light delivery trucks (vans and pickups):

- Passenger cars

B. Trucks

The truck class includes:

- single unit trucks
- truck tractor semitrailer combinations, and
- trucks or truck tractors with semi-trailers in combinations with full trailers.

C. Buses/Recreational Vehicles

The buses/recreational vehicle class includes:

- single unit buses,
- articulated buses,
- motor homes, and
- passenger cars or motor homes pulling trailers or boats.

E.5.2 DESIGN VEHICLE TYPES AND THEIR DIMENSIONS

The design vehicle types established for intersection design control and their symbols are as follows:

P	-	passenger cars; which also represent light trucks (vans and pickups).
PT	-	passenger car towing a dual axle recreational trailer.
B-12	-	single unit inter-city bus.
B-18	-	articulated transit bus.
SU	-	single unit truck.
WB-15	-	tractor - semi-trailer combination; this design vehicle is not representative of the majority of large tractor semi-trailers.
WB-17.5	-	tractor - semi-trailer combination; this design vehicle represents the 13.7 m and 14.0 m length semi-trailers. The current legal trailer length is 14.65 m.
WB-20.5	-	Large tractor - semi-trailer combination. This design vehicle represents maximum dimensions with a trailer length of 16.15 m and currently requires a special permit on Ontario's highway system.
WB-21	-	B-Train; tractor - semitrailer - semitrailer combination; this design vehicle represents maximum dimensions within the overall length of 23 m, the current legal limit in Ontario.

The symbols P, PT, B and SU are derived from vehicle type descriptions and the symbol WB is the abbreviation of wheel base.

The numerals as part of the symbols represent either the overall length or the wheel base of the unit. The wheel base dimension, i.e. axle spacing, is measured from the front axle of the tractor to the rear axle of the semitrailer or pup trailer in the case of a double trailer combination.

The numerals indicate the following measurements of the particular design vehicle:

- B-12 - a rounded overall length of the inter-city bus of 12.2 m.
- B-18 - a rounded overall length of the articulated bus of 18.4 m.
- WB-15 - a rounded axle spacing dimension of 15.2 m.
- WB-17.5 - the axle spacing of 17.5 m.
- WB-20.5 - the axle spacing of 20.5 m.
- WB-21 - a rounded axle spacing of 21.3 m.

The design vehicle types are depicted in Figure E5-1 and the dimensions are shown in Table E5-1.

The dimensions of design vehicles include maximum values of dimensional trends in motor vehicle manufacture and the design vehicle sizes are greater than those for nearly all vehicles belonging to the corresponding vehicle type category that are expected to be in use several years in the future.

The SU design vehicle characteristics are suitable for all single unit trucks and smaller buses. A separate bus design vehicle is required because of the trend toward buses with longer wheelbases. The geometric design requirements for trucks and buses are much more severe than they are for passenger vehicles. Trucks and buses are wider, have longer wheel bases and require more space for their turning manoeuvres than passenger vehicles.

In the design of any highway facility the largest design vehicle likely to use that facility is selected. A design vehicle with special characteristics that must be considered in dimensioning the travelled roadway is used to determine the critical features such as radii for the inner edge of pavement at intersections and on turning roadways.

E.5.3 DESIGN VEHICLE SELECTION FOR INTERSECTION DESIGN GEOMETRICS

POLICY

ALL INTERSECTIONS SHOULD BE DESIGNED USING THE SU DESIGN VEHICLE UNLESS THE AREA IS PART OF A HIGHWAY BUS ROUTE, OR HAS THE POTENTIAL TO BE USED AS AN INTER-CITY BUS ROUTE, THEN THE B-12 DESIGN VEHICLE SHOULD BE USED AS A MINIMUM FOR DESIGN PURPOSES.

At most intersections where, based on the regional traffic count, long truck traffic is predominant, a design vehicle for semi-trailer combinations should be considered in design when the following applies:

if the number of turning semitrailer combinations within the WB-15 type or larger exceeds 10 vehicles per hour (vph) and the turning traffic volume exceeds 100 vph, as determined by the Regional Traffic Section, then the WB-15 design vehicle should be used as a minimum for the design.

In locations where it is known or anticipated that there will be a significant number of turning trucks larger than the WB-15 design vehicle type, a vehicle classification traffic count should be obtained from the Regional Traffic Section to determine the number of WB-17.5 and WB-20.5 design vehicle types within the turning traffic volume and should be considered in design when the following applies:

if the number of turning WB-17.5 type or larger exceeds 1 vph and the turning volume exceeds 100 vph, then the WB-17.5 design vehicle should be given consideration.

if the number of turning WB-20.5 types exceeds 1 vph and turning volume exceeds 100 vph, then the WB-20.5 design vehicle should be given consideration.

Intersections should be designed to accommodate large trucks by providing the extra space demanded by such trucks negotiating turns. Operational demands, eg. feeder routes to and from freight terminals etc. should be given consideration.

The choice of the design vehicle should be based on local traffic counts with consideration to potential future traffic growth, particularly if the roads are in an area where industrial or resource development is planned.

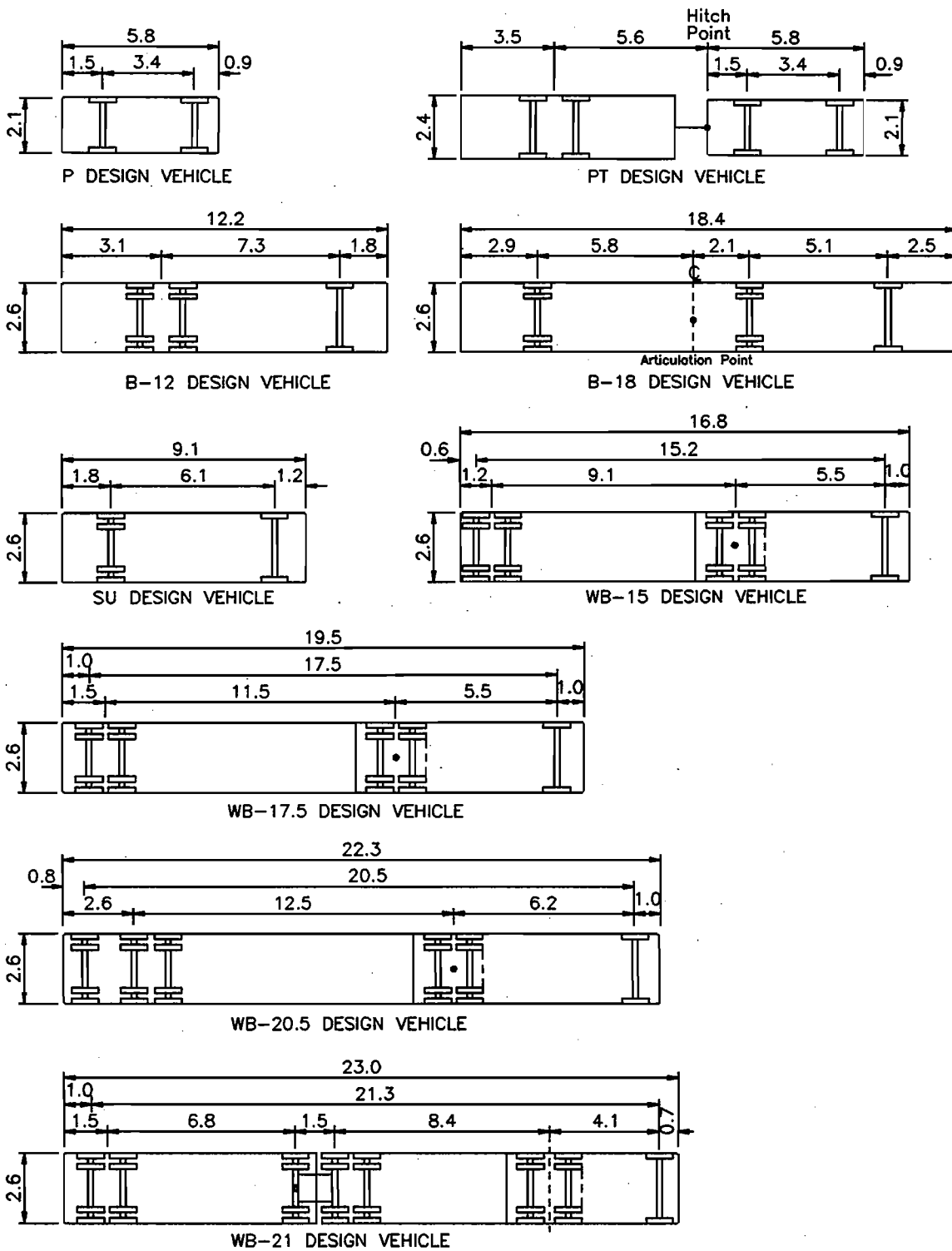

Figure E5-1
Design Vehicle Types

Table E5-1

DESIGN VEHICLE DIMENSIONS

DESIGN VEHICLE		DIMENSIONS (m)				
TYPE	SYMBOL	WHEEL BASE	FRONT OVER HANG	REAR OVER HANG	OVER ALL LENGTH	OVER ALL WIDTH
Passenger Car	P	3.4	0.9	1.5	5.8	2.1
P Car and Trailer	PT	10.5	0.9	3.5	14.9	2.4
Single Unit Inter-City Bus	B-12	7.3	1.8	3.1	12.2	2.6
Articulated Transit Bus	B-18	13.0	2.5	2.9	18.4	2.6
Single Unit Truck	SU	6.1	1.2	1.8	9.1	2.6
Tractor-Semitrailer Combination	WB-15	15.2	1.0	0.6	16.8	2.6
Tractor-Semitrailer Combination	WB-17.5	17.5	1.0	1.0	19.5	2.6
Large Tractor-Semitrailer Combination	WB-20.5	20.5	1.0	0.8	22.3	2.6
Tractor-Semitrailer-Semi-Trailer Combination	WB-21	21.3	0.7	1.0	23.0	2.6

Table E5-2

MINIMUM TURNING RADII OF DESIGN VEHICLES

DESIGN VEHICLES									
SYMBOL	P	PT	B-12	B-18	SU	WB-15	WB-17.5	WB-20.5	WB-21
MINIMUM TURNING RADIUS	7.5	7.5	15	12	13	14	14	14	12

E.5.4 DESIGN VEHICLES' TURNING PATHS AND TEMPLATES; MINIMUM TURNING RADII

The principal factors and dimensions of the design vehicle affecting the intersection design are:

- the minimum turning radius,
- the wheelbase,
- the path of the inner rear wheel,
- the front overhang,
- the operational speed of the turning vehicle, and
- the driver performance or driving characteristics.

It is assumed that the left outer front wheel of the vehicle follows a circular curve defining the minimum turning radius as determined by the vehicle steering mechanism. For minimum turning radii, see Table E5-2.

The width of the design vehicle turning path or swept path depends on the

design vehicle dimensions,

turning radius, and

turning angle

and is established by the outer trace of the front overhang and the path of the inner rear wheel, as shown in Figure E5-2.

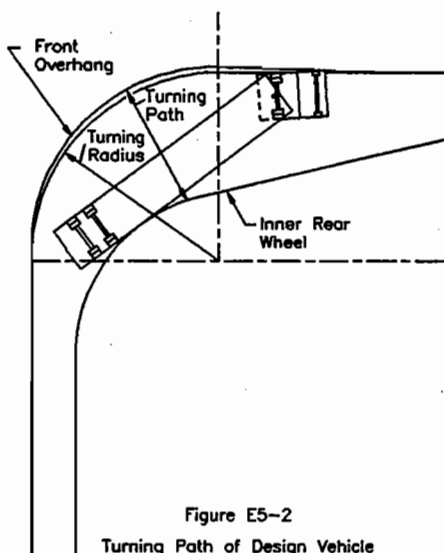

Figure E5-2

Turning Path of Design Vehicle

The turning path of each design vehicle is the minimum attainable at a selected speed and the minimum turning radius is slightly above the minimum performance capability of the vehicles in the design vehicle type e.g. turning radius 14 m; turning capability 13.5 m. The turning speed of the vehicle for the minimum radius is less than 15 km/h.

The geometric configuration of the intersection and the selected vehicle size should satisfy the following conditions: - (a) The turning path of the vehicles' wheels stays within the paved area of the roadway and (b) the swept path of the vehicles' body avoids all other vehicles and fixed objects.

To facilitate the layout of the intersections and to ensure proper design, a set of templates for turning vehicle paths is available.

These templates, made of clear plastic sheet, were originally developed by manual methods primarily from field tests and can only be used on the board with hardcopy plans. Vehicle turning templates are the most widely used tool in determining the swept path of a vehicle.

The design vehicle turning templates are available in four normally used scales 1:200, 1:250, 1:500, and 1:1000.

A template is not required for a passenger vehicle (P). A minimum turning radius for a passenger vehicle is 7.5 m for design purposes. However, the recommended edge of pavement design at open throat intersections advises a standard radius of 10 m for urban conditions and 15 m for rural conditions.

The design vehicle templates may be used either for right or left turn movements as indicated in Table E5-3.

With the advent of computer technology methods to simulate the turning paths of specific design vehicles have emerged and programs are available which perform in the AutoCad environment.

The offtracking computer program developed in this ministry may be used to develop turning templates and is especially valuable when analyzing other than standard design vehicle types.

Table E5-3

DESIGN VEHICLE AND TURNING CONDITION

DESIGN VEHICLE	MINIMUM TURNING RADIUS AND TURNING CONDITION	TURNING SPEED	TURNING CONDITION
SU SU	13m - (a) 18m - (b)	<15 km/h 15 - 25 km/h	<p>(a) The vehicle commences a turn from a stationary position, such as would occur from a side road, controlled by a stop, to a main highway.</p> <p>(b) The vehicle commences a turn at speeds from 15 to 25 km/h, such as would occur in a turning manoeuvre right or left from a main highway or a side road.</p> <p>(c) The vehicle commences a turn at speeds slightly higher than 25 km/h, such as would occur on a separate left turn lane at median openings. This condition does not apply to the SU design vehicle.</p>
B-12 B-12	15m - (a) 20m - (b)	<15 km/h 15 - 25 km/h	
WB-15 WB-15 WB-15	14m - (a) 18m - (b) 22m - (c)	<15 km/h 15 - 25 km/h >25 km/h	
WB-17.5 WB-17.5 WB-17.5	14m - (a) 18m - (b) 22m - (c)	<15 km/h 15 - 25 km/h >25 km/h	
WB-20.5 WB-20.5 WB-20.5	14m - (a) 18m - (b) 22m - (c)	<15 km/h 15 - 25 km/h >25 km/h	
WB-20.5 WB-20.5 WB-20.5	14m - (a) 18m - (b) 22m - (c)	<15 km/h 15 - 25 km/h >25 km/h	

Note: Truck turning templates have been developed for low-speed offtracking

E.5.4.1 Low-Speed Offtracking

When a large truck is driven at low speed with the left front wheel following a specified curve, called the turning radius, the rear wheels of the vehicle track inside those at the front and produce low-speed offtracking. The demand for space while turning is based upon the phenomenon of low-speed offtracking.

The design vehicle turning templates have been developed for low-speed offtracking on level surfaces. Low-speed offtracking is a function of truck characteristics and roadway geometrics.

E.5.4.2 High-Speed Offtracking

When a vehicle makes a turn at high speed, the rear of the vehicle moves outward because of the lateral acceleration of the vehicle as it negotiates a horizontal curve at higher speeds.

High speed offtracking is a function not only of truck characteristics and roadway geometrics, but also of vehicle speed and the vehicles' suspension, tire and loading characteristics.

For design purposes, the pavement widening provided on turns to compensate for low-speed offtracking is considered adequate for high-speed offtracking.

E.5.4.3. Minimum Turning Paths of Design Vehicles

Figures E5-3 to E5-6 represent the templates most frequently used in design for the truck classifications SU, WB-15, WB-17.5 and WB-20.5. These turning templates show the turning paths of the design vehicles used in this ministry.

For the WB-21 truck classification the WB-17.5 templates should be used; **do not** use the WB-20.5. The minimum turning radius for the WB-21 is 12 m and offtracking is less than the WB-20.5 with a turning radius of 14 m.

A set of templates available from the Surveys and Design Office provides for a variety of design conditions for the design vehicles as follows:

TURNING CONDITION (a)

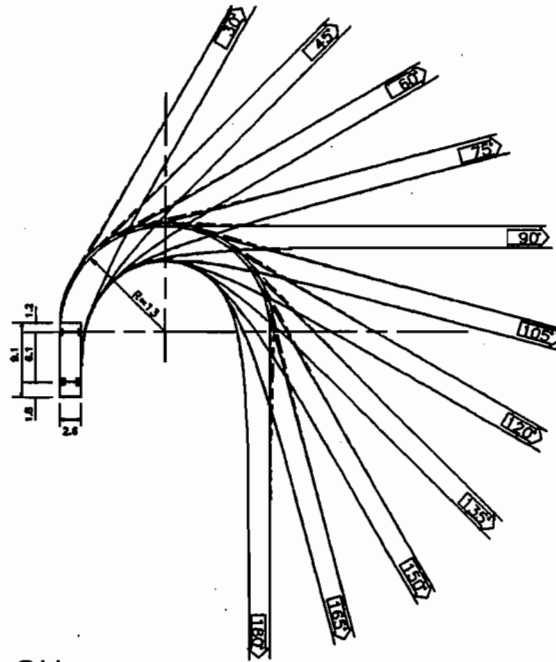

SU

STOP CONDITION
R = 13

TURNING CONDITION (b)

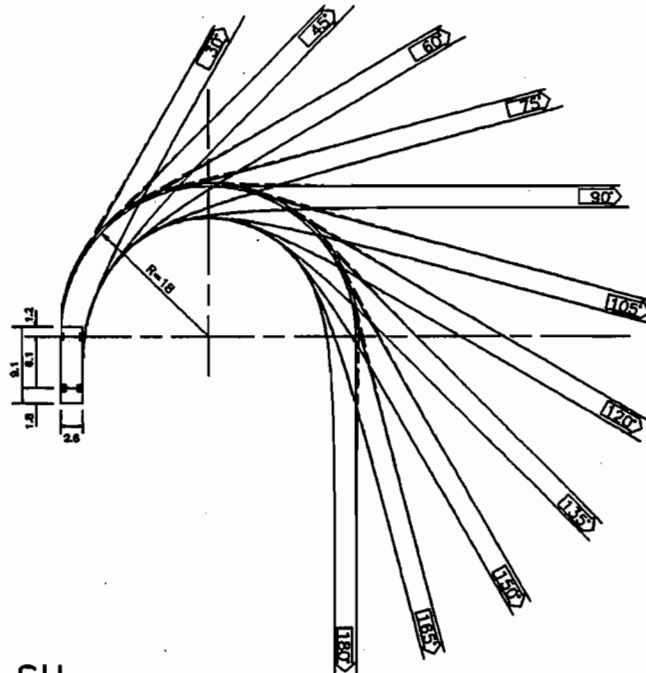

SU

TURNING SPEED 15–25km/h
R = 18

Figure E5-3
Truck Turning Templates
Minimum Turning Path for SU Design Vehicle

TURNING CONDITION (a)

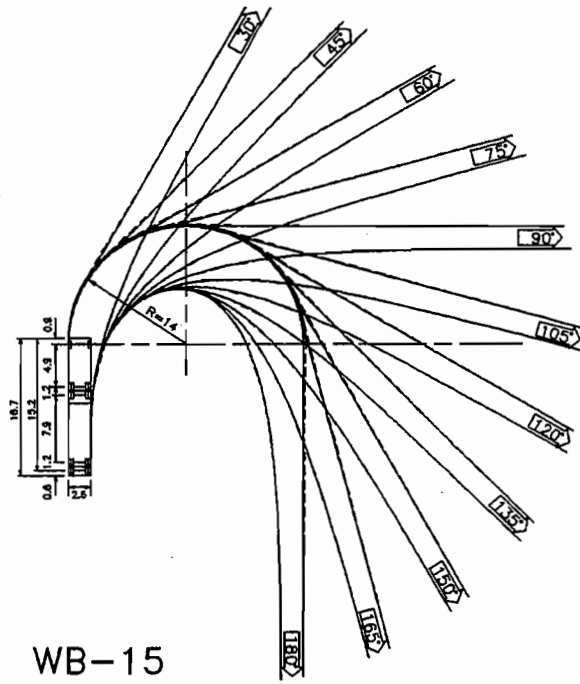

WB-15

STOP CONDITION
R = 14

TURNING CONDITION (b)

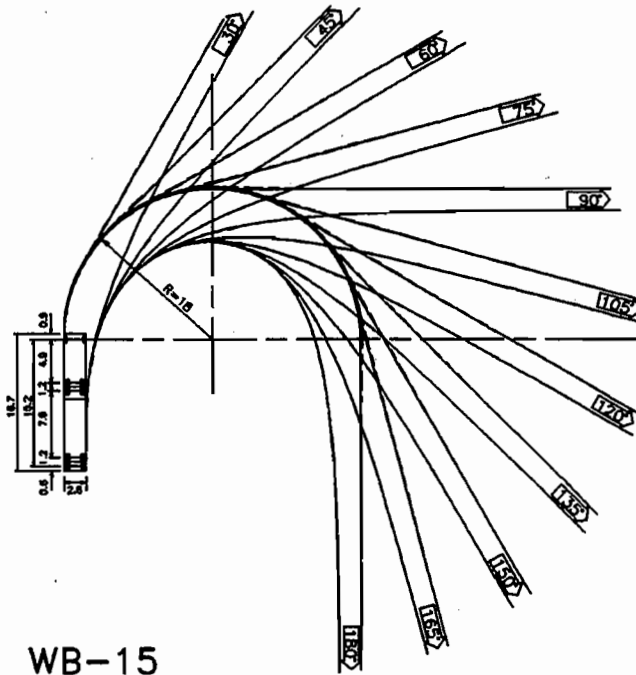

WB-15

TURNING SPEED 15-25km/h
R = 18

Figure E5-4
Truck Turning Templates
Minimum Turning Path for WB-15 Design Vehicle

TURNING CONDITION (a)

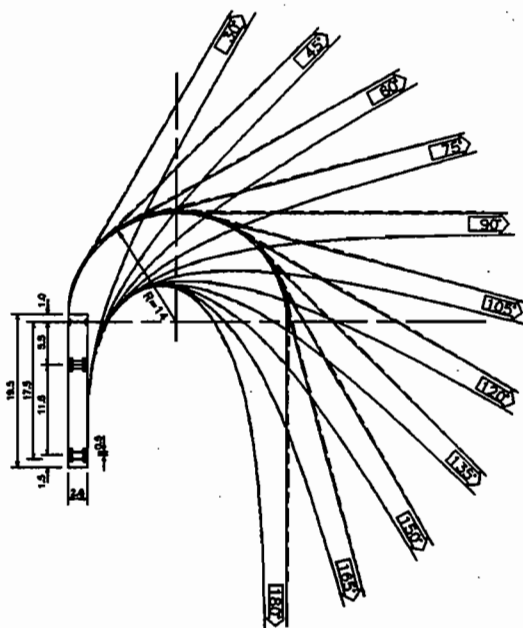

WB-17.5

STOP CONDITION

R = 14

TURNING CONDITION (b)

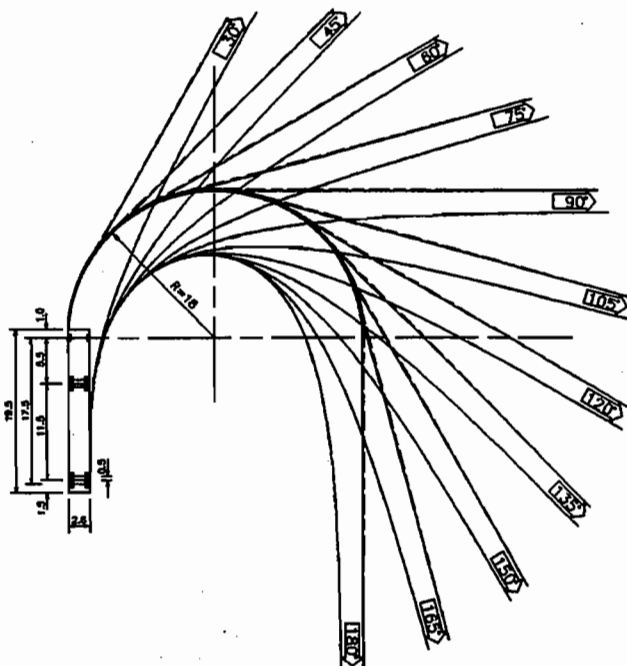

WB-17.5

TURNING SPEED 15-25km/h

R = 18

Figure E5-5
Truck Turning Templates - Minimum Turning Path for WB-17.5 Design Vehicle
(To be Used for WB-21 Design Vehicle)

TURNING CONDITION (a)

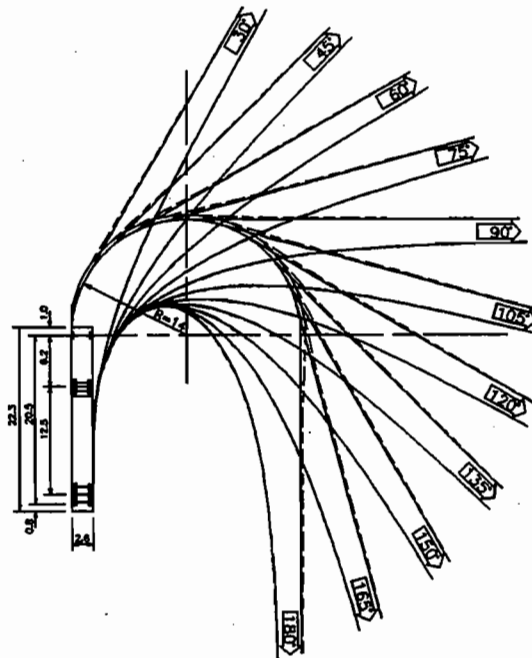

WB-20.5

STOP CONDITION

R = 14

TURNING CONDITION (b)

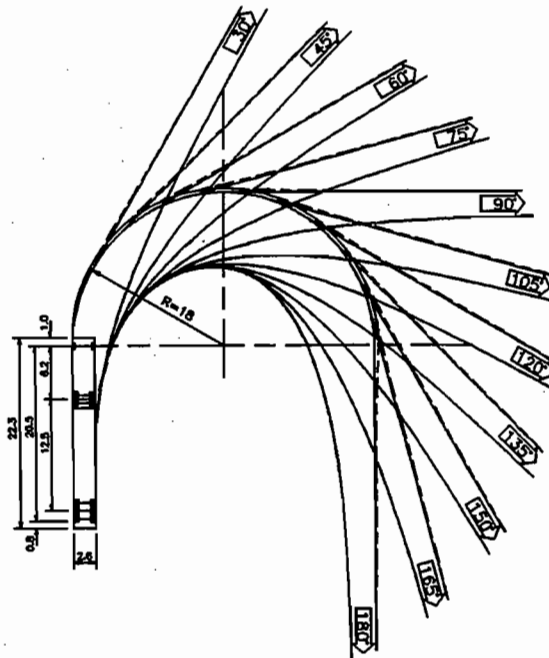

WB-20.5

TURNING SPEED 15-25km/h

R = 18

Figure E5-6
Truck Turning Template
Minimum Turning Path for WB-20.5 Design Vehicle

E.5.5 APPLICATION OF DESIGN VEHICLE TURNING TEMPLATES

An illustration of applying design vehicle turning templates to establish the minimum vehicle path and minimum pavement requirements for turning conditions (a) or (b) is shown in Figure E5-7, E5-8 and E5-9.

Figure E5-7 shows the application of a design vehicle turning template for a stop controlled intersection at the side road; condition (a). The turning radius is 13 m for a single unit commercial vehicle (SU) and 14 m for truck tractor semitrailer combinations of either WB-15, WB-17.5 or WB-20.5.

Figure E5-8 illustrates design vehicle turning requirements for exits from the main highway to the side road or for a yield condition from the side road to

the main highway; condition (b). The turning radius is 18 m for SU, WB-15, WB-17.5 and WB-20.5 and may also be required at signalized intersections.

Figure E5-9 shows the treatment for either stop sign or signal control on a four lane highway applying both condition (a) and condition (b). Note that on four-lane highways with a low turning volume for the side-road a single circular and not a two-centre compound curve is applied as the commercial vehicles use both lanes in making a right turn manoeuvre from the side road to the main highway. Where it becomes necessary to have the truck turn into the right lane of the highway a two-centre compound curve may be designed.

The WB-15, WB-17.5 and WB-20.5 turning templates having a turning radius of 22 m for condition (c) are applied in the left turn lane at median openings. See Figure E10-10 and E10-11 for application.

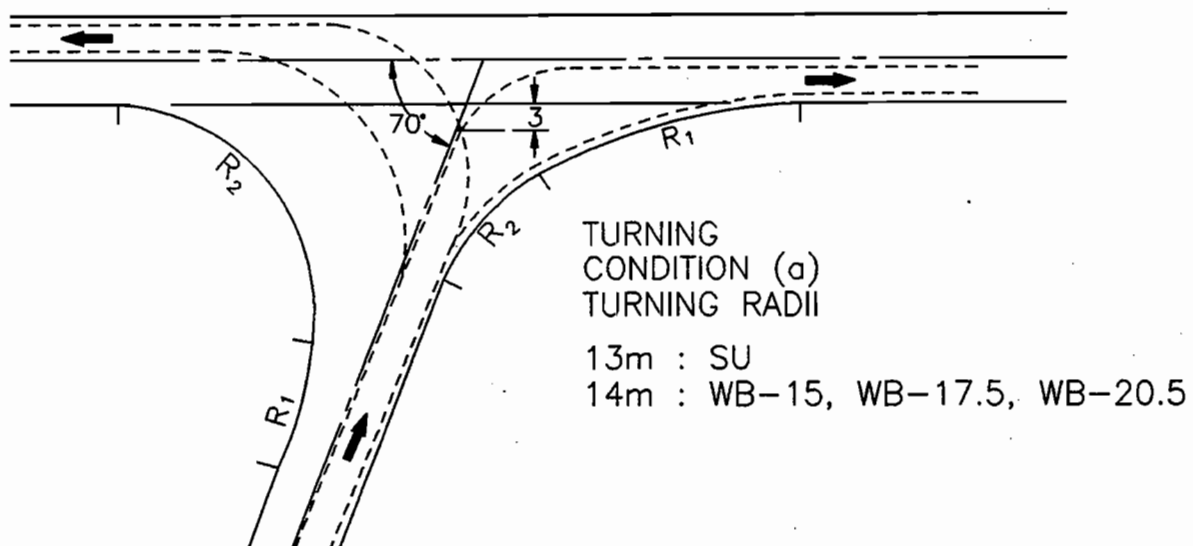

Figure E5-7

Application of Design Vehicle Turning Templates

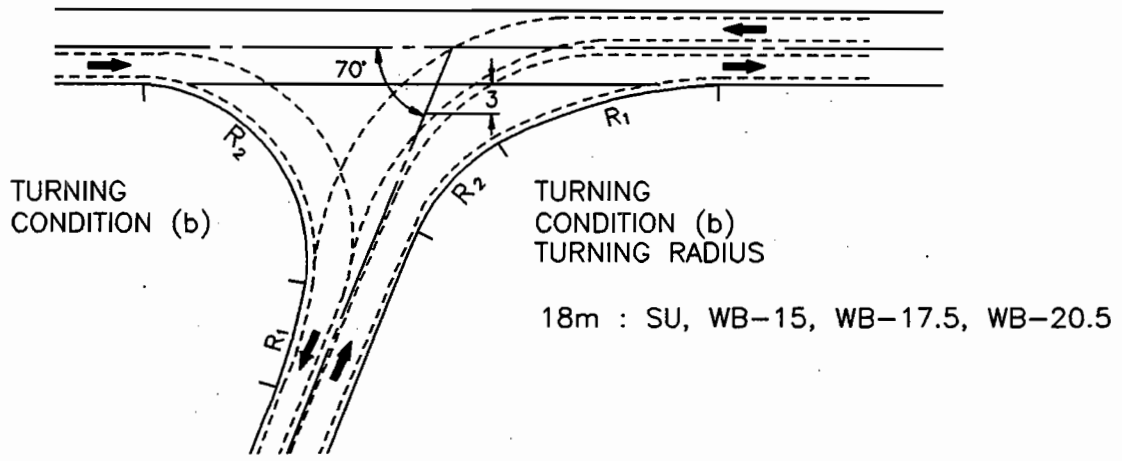

Figure E5-8

Application of Design Vehicle Turning Templates

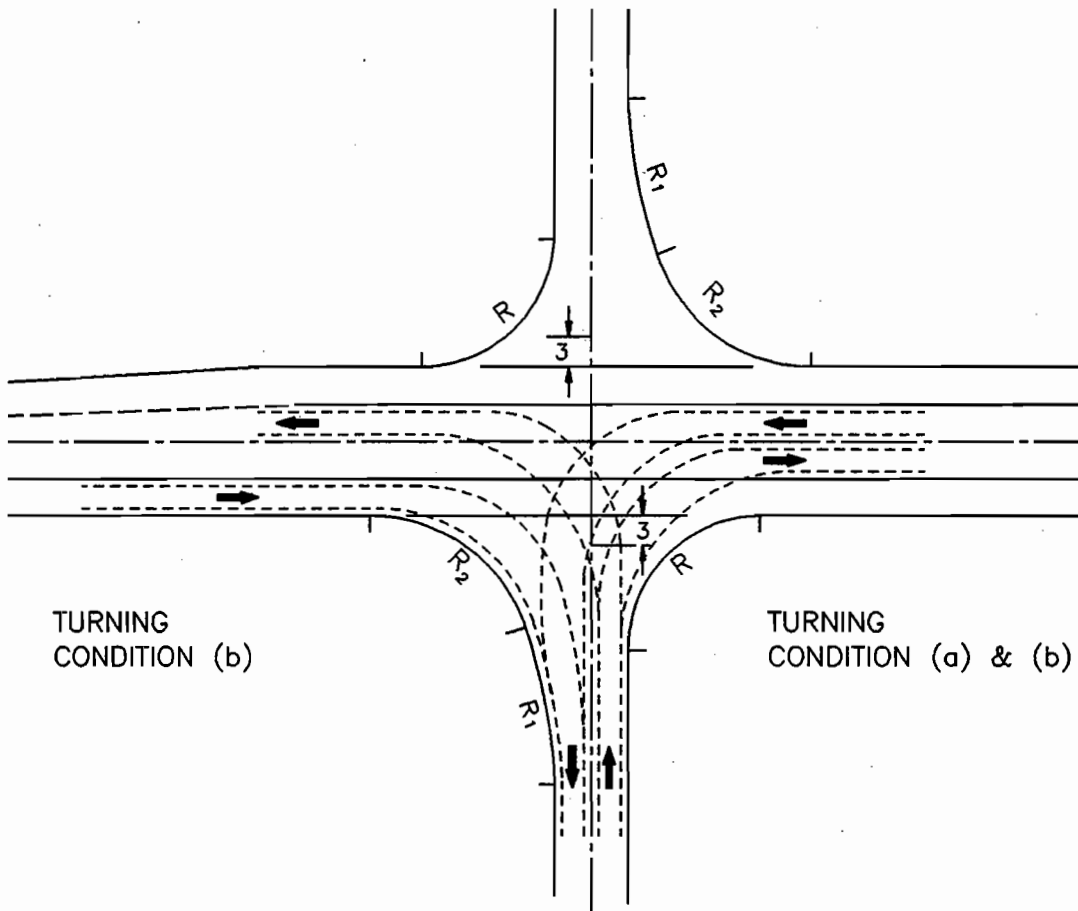

Figure E5-9

Application of Design Vehicle Turning Templates

E.5.6. WIDENING OF THE SIDE ROAD AT INTERSECTIONS

Where trucks are an important factor in a left turning movement to a side road, it usually becomes necessary to widen the throat of the side road to accommodate the wheels of the turning vehicles, thus avoiding tracking onto the shoulder or interfering with a vehicle standing on the side road.

For the edge of pavement detail design as applied to the right turn from side road to main highway, refer to Sub-Chapter 6, Simple Open Throat Intersections.

An area designed to represent an island is utilized in the throat to guide the vehicle and control the turning manoeuvre. The need for an island and its configuration is determined by the use of design vehicle templates and varies with:

- The type of vehicle,
- the width of highway cross-section, and
- the angle of intersection.

For illustrations see Figures E5-10 and E5-11.

An intersection design having an adverse turning angle as shown in Figure E5-11 is an acceptable standard. However, it can be improved by realignment of the side road to form approximately a 90° intersection angle with the main highway.

Where the turning angle is less than 90° and favourable to the turning manoeuvre, and where trucks turning left from the highway do not encroach on the shoulder, it is not necessary to widen the side road cross-section as the pavement widening is provided by the edge of pavement design, consisting of two-centre compound curves for right turn movements of commercial vehicles. See Figure E5-12.

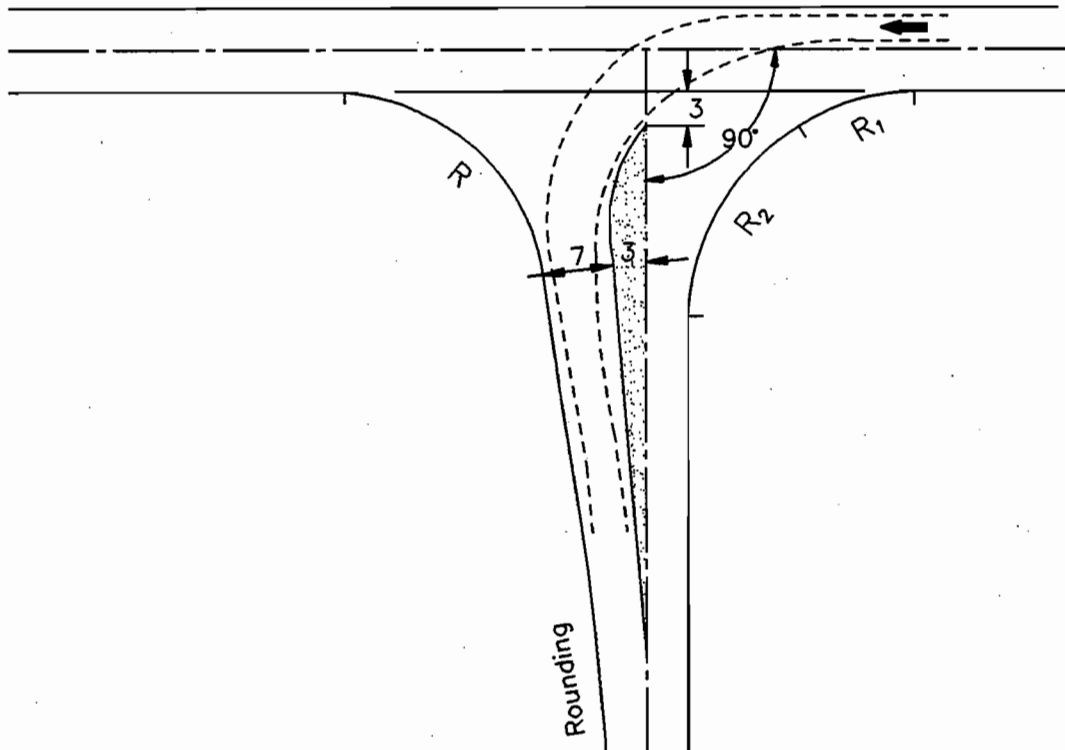

Figure E5-10

Widening of Side Road at 'T' Intersections

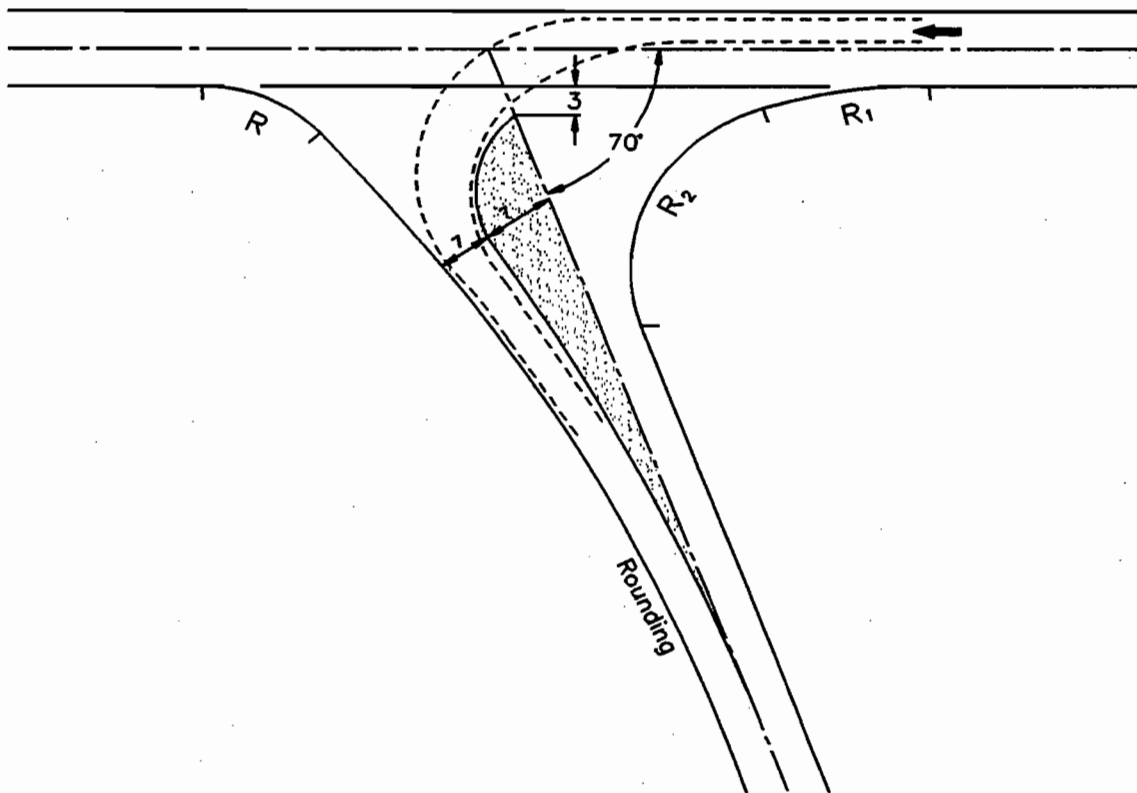

Figure E5-11

Widening of Side Road at 'T' Intersections

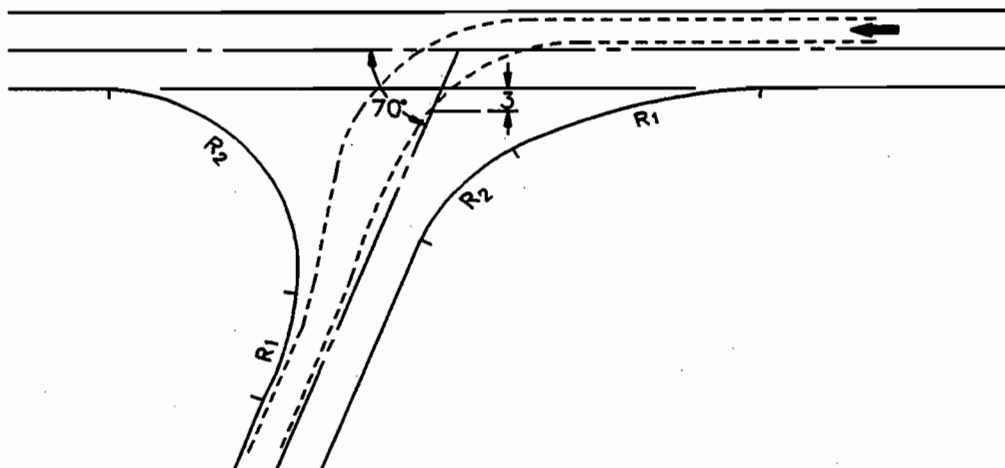

Figure E5-12

Widening of Side Road at 'T' Intersections

In the case of a cross intersection where the side road widening is necessary, the approach lanes for the advancing traffic are adjusted to line up with the

continuation of these lanes on the opposite side of the intersection. This provides a smooth alignment for the side road traffic flow. See Figure E5-13.

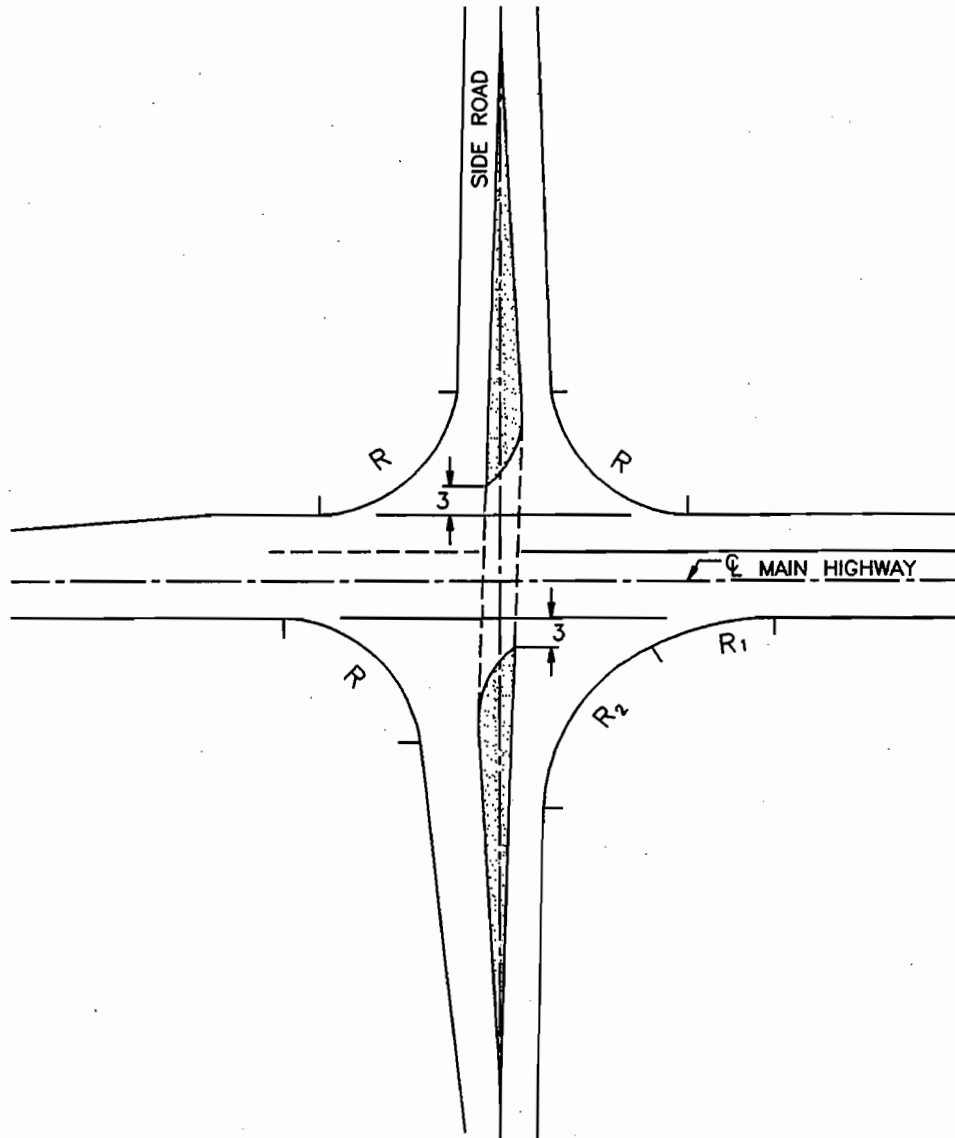

Figure E5-13

Widening of Side Road at 'Cross' Intersections

**E.5.7 SPECIAL DESIGN CONSIDERATIONS;
FARM EQUIPMENT**

In highly mechanized agricultural areas where the heavy and large size equipment is often moved along the highway system, at grade intersections should be designed to accommodate the turning manoeuvres.

As a general rule, the dimensions, which include axle spacing, front and rear overhang and width of the equipment, are obtained and the pavement width requirements determined. The computerized method is recommended to simulate the turning path of other than standard design vehicles and ascertain space and layout requirements.

AT-GRADE INTERSECTIONS

E.6 SIMPLE OPEN THROAT INTERSECTIONS

E.6.1 MINIMUM DESIGNS; MINIMUM RADII CURVES

At open throat intersections, also called simple or unchannelized intersections, the minimum turning paths, specifically the path of the inner rear wheel and the front overhang of the design vehicle, are used to establish controls for the selection of the minimum edge of pavement curves.

For simple open throat intersections either a circular or a two-centred compound circular curve is applied.

E.6.2 SELECTION OF CIRCULAR AND TWO-CENTRED COMPOUND CIRCULAR CURVES

The selection of an appropriate radius of curve depends on the type of chosen design vehicle and the turning condition, as discussed in Section E.5, which also describes the application of design vehicle templates. The design vehicles generally selected to control the edge of pavement design are: SU, B-12, WB-15 and WB-17.5. For the larger WB-20.5 design vehicle the recommended radii combination for the WB-17.5 should be checked with the appropriate template and adjusted if necessary.

The turning condition is either stop; such as would occur in a right turning manoeuvre from a side road or a ramp, controlled by a stop sign, or yield; such as would occur in a right turning manoeuvre from an uncontrolled highway to a side road.

The angle of turn is the angle between the extension of the tangent on which the vehicle approaches and the tangent on to which the vehicle turns.

E.6.3 APPLICATION OF CIRCULAR AND TWO-CENTRED COMPOUND CIRCULAR CURVES; MINIMUM RADII CURVES

(a) Circular Curve

This curve is used mostly on all intersections and facilitates the passenger vehicle, single unit truck and single unit-city bus turning manoeuvres. The size of the radius is dependent on the minimum turning radius of the selected design vehicle and turning condition; either stop or yield, i.e. turning at low speeds.

Figure E6-1 illustrates the curve elements. Table E6-1 provides curve data values for angles of turn between 70° and 110° at 5° intervals for SU and B-12 design vehicles. The indicated radii values for

SIMPLE OPEN THROAT INTERSECTIONS

the edge of pavement design are minimum for the SU and B-12 design vehicles turning paths without encroachment on the adjacent lane.

The circular curve design is used also where the right turning semi-trailer combinations approaching on a single lane can manoeuvre into a four-lane highway section, as the large trucks use more than one lane in making their turn, see Figure E5-9. Where it becomes necessary to have large trucks turn into the right lane of a multi-lane highway section a two-centred compound curve design is appropriate.

(b) Two-centred Compound Circular Curve

This curve is used to facilitate the right turning manoeuvre of tractor-semitrailer combinations. Figure E6-2 illustrates the application, symbol and nomenclature of the two-centred compound circular curve elements. Minimum curve combinations have been selected for the WB-15 and WB-17.5 design vehicles, see Table E6-2. The table provides radii combinations (R_2 & R_1) for angles of turn between 70° and 110° at 5° intervals. Tables E6-3, E6-4, E6-5 and E6-6 provide curve data values (T_1 , T_2 , L_1 , L_2 , a and b) of the two-centred compound curves for angles of turn between 70° and 110° at 1° intervals.

For intersection angles lying between those shown in the tables and for intersections on curved alignment use the table for the radii combinations and recalculate the appropriate curve data or by graphical means obtain best fitting combination of radii close to the standard.

The lengths of tangents of the compound circular curve (a & b) and the angle subtended at the centre by radius R_1 and R_2 (Δ_1 & Δ_2) can be calculated by using the formulae as shown in section C.3.6, Geometric Calculation N.2.

The radii combinations allow for a minimum clearance of approximately 0.5 m between the inner rear wheel of the design vehicle and the edge of pavement. They were developed for right turning movements from the side road to the main highway, using the minimum turning radius ($R=14$) for stop condition and for right turning movements from the highway to the side road, using the minimum turning radius ($R=18$) for the yield condition, i.e. turning at low speeds.

The two-centred compound curve is the preferred design for all types of large trucks and fits the minimum path of the design semi-trailer combination adequately.

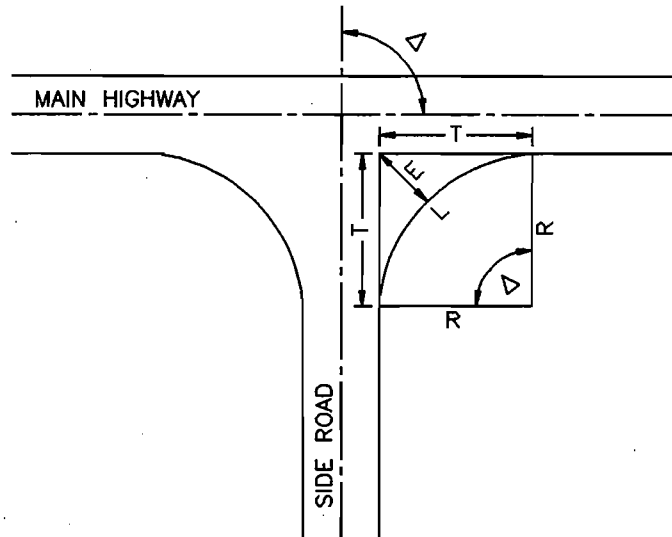

Figure E6-1
Edge of Pavement Design at Simple Open Throat Intersections for P, SU and B-12 Design Vehicles

Table E6-1
MINIMUM CIRCULAR CURVES AT SIMPLE OPEN THROAT INTERSECTIONS FOR URBAN OR RURAL AREAS

Δ°	CIRCULAR CURVES FOR DESIGN VEHICLES *											
	SU : STOP CONDITION R = 15			YIELD CONDITION R = 18			B-12: STOP CONDITION R = 18			YIELD CONDITION R = 20		
	R = 15 m			R = 18 m			R = 20 m					
	T	E	L	T	E	L	T	E	L			
70	10.50	3.31	18.33	12.60	3.97	21.99	14.00	4.42	24.43			
75	11.51	3.91	19.63	13.81	4.69	23.56	15.35	5.21	26.18			
80	12.59	4.58	20.94	15.10	5.50	25.13	16.78	6.11	27.93			
85	13.74	5.35	22.25	16.49	6.41	26.70	18.33	7.13	29.67			
90	15.00	6.21	23.56	18.00	7.46	28.27	20.00	8.28	31.42			
95	16.37	7.20	24.87	19.64	8.64	29.85	21.83	9.60	33.16			
100	17.88	8.34	26.18	21.45	10.00	31.42	23.84	11.11	34.91			
105	19.55	9.64	27.49	23.46	11.57	32.99	26.06	12.85	36.65			
110	21.42	11.15	28.80	25.71	13.38	34.56	28.56	14.87	38.40			

* Edge of pavement design for P-design vehicle: R=10 m - urban areas
R=15 m - rural areas
For minor-local roads the radius (R) may be reduced to 5 m in urban areas and 10 m in rural areas.

AT-GRADE INTERSECTIONS

For the large tractor-semitrailer combination WB-20.5 the recommended radii combination of the WB-17.5 design vehicle should be checked with the appropriate template and adjusted if necessary. The recommended clearance between the inner rear wheel and the edge of pavement should be 0.5 m preferably and not less than 0.25 m. When applying the template the vehicle is properly positioned within the traffic lane at the beginning and end of the turn and the inner rear wheel path is clearing the curve with the indicated minimum clearance. The application of the design vehicle template is described in Section E.5.5.

SIMPLE OPEN THROAT INTERSECTIONS

When facilitating the large trucks prudence is advised for angles of turn of 105 degrees or more and channelization may be considered to prevent large paved areas that may be difficult to control.

When pedestrians are a consideration at a signalized wide open throat intersection the "walk" and clearance times may be affected, hence providing adequate service and protection for pedestrians may be required.

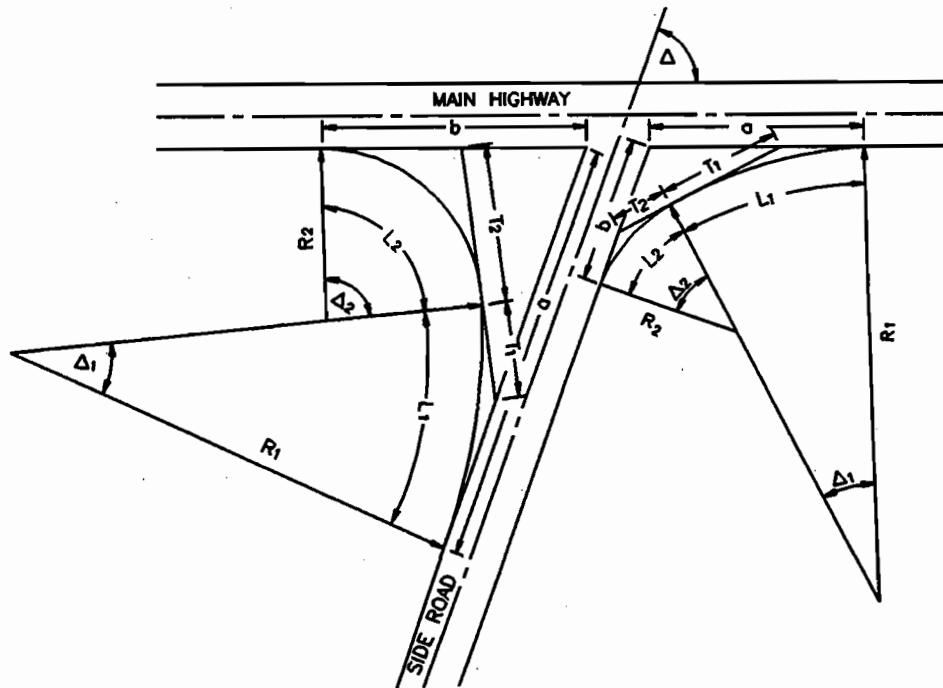

- Δ - Intersection angle of the two roads
- R_1 - Radius of curve Δ_1
- R_2 - Radius of curve Δ_2
- Δ_1 - Angle subtended at the centre by radius R_1
- Δ_2 - Angle subtended at the centre by radius R_2
- T_1, T_2 - Length of tangent
- L_1, L_2 - Length of curve
- a - Long tangent of the compound circular curve
- b - Short tangent of the compound circular curve

Figure E6-2
Edge of Pavement Design at Simple Open Throat Intersections
for Tractor-Semitrailer Combinations

Table E6-2

MINIMUM TWO-CENTRED COMPOUND CIRCULAR CURVES AT SIMPLE OPEN THROAT INTERSECTIONS FOR URBAN AND RURAL AREAS

STOP CONDITION		
WB-15 DESIGN VEHICLE		
Δ°	R ₂	R ₁
70-74	18	80
75-84	17	80
85-91	16	80
92-99	15	80
100-110	14	90
WB-17.5 DESIGN VEHICLE		
Δ°	R ₂	R ₁
70-71	22	110
72-74	21	110
75-77	21	110
78-83	19	110
84-90	18	110
91-94	17	110
95-99	16	110
100-110	15	120

YIELD CONDITION		
WB-15 DESIGN VEHICLE		
Δ°	R ₂	R ₁
70-73	21	130
74-79	20	130
80-89	19	130
90-101	18	130
102-109	17	140
110	16	150
WB-17.5 DESIGN VEHICLE		
Δ°	R ₂	R ₁
70-71	24	130
72-76	23	130
77-85	22	130
86-94	21	130
95-96	20	130
97-105	19	140
106-110	18	140

Below the double line channelization may be required

For the full range of the design values see Table E6-3, E6-4, E6-5 and E6-6

Table E6-3

**TWO-CENTRE COMPOUND CURVES
FOR DESIGN VEHICLE WB-15
STOP CONDITION FROM SIDE ROAD TO MAIN HIGHWAY
ON TANGENT ALIGNMENT**

Δ	Δ_2	R_2	T_2	L_2	Δ_1	R_1	T_1	L_1	a	b
70°	53°30'	18	9.073	16.808	16°30'	80	11.599	23.038	29.283	15.321
71°	54°35'	18	9.287	17.148	16°25'	80	11.540	22.922	29.491	15.513
72°	55°40'	18	9.504	17.488	16°20'	80	11.481	22.806	29.701	15.709
73°	56°45'	18	9.722	17.829	16°15'	80	11.421	22.689	29.911	15.909
74°	57°50'	18	9.943	18.169	16°10'	80	11.362	22.573	30.124	16.115
75°	58°55'	17	9.602	17.481	16°05'	80	11.303	22.457	29.837	15.597
76°	60°00'	17	9.815	17.802	16°00'	80	11.243	22.340	30.039	15.797
77°	61°00'	17	10.014	18.099	16°00'	80	11.243	22.340	30.324	16.027
78°	62°00'	17	10.215	18.396	16°00'	80	11.243	22.340	30.613	16.261
79°	63°00'	17	10.418	18.692	16°00'	80	11.243	22.340	30.904	16.500
80°	64°00'	17	10.623	18.989	16°00'	80	11.243	22.340	31.200	16.743
81°	65°00'	17	10.830	19.286	16°00'	80	11.243	22.340	31.498	16.990
82°	66°00'	17	11.040	19.583	16°00'	80	11.243	22.340	31.800	17.242
83°	67°00'	17	11.252	19.879	16°00'	80	11.243	22.340	32.106	17.499
84°	68°00'	17	11.467	20.176	16°00'	80	11.243	22.340	32.416	17.761
85°	69°00'	16	10.996	19.268	16°00'	80	11.243	22.340	32.085	17.150
86°	70°00'	16	11.203	19.548	16°00'	80	11.243	22.340	32.388	17.406
87°	71°00'	16	11.413	19.827	16°00'	80	11.243	22.340	32.694	17.666
88°	72°00'	16	11.625	20.106	16°00'	80	11.243	22.340	33.005	17.932
89°	73°00'	16	11.839	20.385	16°00'	80	11.243	22.340	33.321	18.203
90°	74°00'	16	12.057	20.665	16°00'	80	11.243	22.340	33.641	18.479
91°	75°00'	16	12.227	20.944	16°00'	80	11.243	22.340	33.966	18.761
92°	76°00'	15	11.719	19.897	16°00'	80	11.243	22.340	33.537	18.052
93°	77°00'	15	11.932	20.159	16°00'	80	11.243	22.340	33.855	18.328
94°	78°00'	15	12.147	20.420	16°00'	80	11.243	22.340	34.178	18.610
95°	79°00'	15	12.365	20.682	16°00'	80	11.243	22.340	34.506	18.897
96°	80°00'	15	12.586	20.944	16°00'	80	11.243	22.340	34.840	19.191
97°	81°00'	15	12.811	21.206	16°00'	80	11.243	22.340	35.180	19.491
98°	82°00'	15	13.039	21.468	16°00'	80	11.243	22.340	35.526	19.798
99°	83°00'	15	13.271	21.729	16°00'	80	11.243	22.340	35.878	20.112
100°	84°00'	14	12.606	20.525	16°00'	90	12.649	25.133	38.152	19.674
101°	85°00'	14	12.829	20.769	16°00'	90	12.649	25.133	38.504	19.983
102°	86°00'	14	13.055	21.014	16°00'	90	12.649	25.133	38.863	20.298
103°	87°00'	14	13.286	21.258	16°00'	90	12.649	25.133	39.229	20.622
104°	88°10'	14	13.520	21.502	16°00'	90	12.649	25.133	39.602	20.953
105°	89°00'	14	13.798	21.788	15°50'	90	12.515	24.871	39.754	21.230
106°	90°20'	14	14.082	22.073	15°40'	90	12.382	24.609	39.911	21.516
107°	91°30'	14	14.371	22.358	15°30'	90	12.248	24.347	40.075	21.810
108°	92°40'	14	14.667	22.643	15°20'	90	12.115	24.086	40.245	22.114
109°	93°50'	14	14.969	22.928	15°10'	90	11.982	23.824	40.422	22.427
110°	95°00'	14	15.278	23.213	15°00'	90	11.849	23.562	40.607	22.750

Table E6-4

**TWO-CENTRE COMPOUND CURVES
FOR DESIGN VEHICLE WB-15
YIELD CONDITION; TANGENT ALIGNMENT**

Δ	Δ_2	R_2	T_2	L_2	Δ_1	R_1	T_1	L_1	a	b
70°	58°00'	21	11.640	21.258	12°00'	130	13.664	27.227	36.500	17.239
71°	59°00'	21	11.881	21.625	12°00'	130	13.664	27.227	36.822	17.498
72°	60°00'	21	12.124	21.991	12°00'	130	13.664	27.227	37.146	17.762
73°	61°00'	21	12.370	22.358	12°00'	130	13.664	27.227	37.474	18.030
74°	62°00'	20	12.017	21.642	12°00'	130	13.664	27.227	37.253	17.572
75°	63°00'	20	12.256	21.991	12°00'	130	13.664	27.227	37.574	17.835
76°	64°00'	20	12.497	22.340	12°00'	130	13.664	27.227	37.897	18.103
77°	65°00'	20	12.741	22.689	12°00'	130	13.664	27.227	38.225	18.375
78°	66°00'	20	12.988	23.038	12°00'	130	13.664	27.227	38.556	18.653
79°	67°00'	20	13.238	23.307	12°00'	130	13.664	27.227	38.891	18.936
80°	68°00'	19	12.816	22.550	12°00'	130	13.664	27.227	38.595	18.406
81°	69°00'	19	13.058	22.881	12°00'	130	13.664	27.227	38.922	18.683
82°	70°00'	19	13.304	23.213	12°00'	130	13.664	27.227	39.255	18.966
83°	71°00'	19	13.553	23.544	12°00'	130	13.664	27.227	39.591	19.254
84°	72°00'	19	13.804	23.876	12°00'	130	13.664	27.227	39.932	19.546
85°	73°00'	19	14.059	24.208	12°00'	130	13.664	27.227	40.277	19.845
86°	74°00'	19	14.318	24.589	12°00'	130	13.664	27.227	40.628	20.150
87°	75°00'	19	14.579	24.871	12°00'	130	13.664	27.227	40.982	20.459
88°	76°00'	19	14.844	25.203	12°00'	130	13.664	27.227	41.342	20.775
89°	77°00'	19	15.113	25.534	12°00'	130	13.664	27.227	41.708	21.097
90°	78°00'	18	14.576	24.504	12°00'	130	13.664	27.227	41.287	20.447
91°	79°00'	18	14.838	24.819	12°00'	130	13.664	27.227	41.647	20.765
92°	80°00'	18	15.104	25.133	12°00'	130	13.664	27.227	42.012	21.089
93°	81°00'	18	15.373	25.447	12°00'	130	13.664	27.227	42.383	21.418
94°	82°00'	18	15.647	25.761	12°00'	130	13.664	27.227	42.761	21.756
95°	83°00'	18	15.925	26.075	12°00'	130	13.664	27.227	43.145	22.100
96°	84°00'	18	16.207	26.389	12°00'	130	13.664	27.227	43.535	22.452
97°	85°00'	18	16.494	26.704	12°00'	130	13.664	27.227	43.933	22.811
98°	86°00'	18	16.785	27.018	12°00'	130	13.664	27.227	43.337	23.178
99°	87°00'	18	17.081	27.332	12°00'	130	13.664	27.227	44.750	23.553
100°	88°00'	18	17.382	27.646	12°00'	130	13.664	27.227	45.170	23.936
101°	89°00'	18	17.689	27.960	12°00'	130	13.664	27.227	45.599	24.330
102°	90°00'	17	17.000	26.704	12°00'	140	14.715	29.322	47.139	23.741
103°	91°00'	17	17.299	27.000	12°00'	140	14.715	29.322	47.566	24.130
104°	92°00'	17	17.604	27.297	12°00'	140	14.715	29.322	48.003	24.529
105°	93°00'	17	17.914	27.594	12°00'	140	14.715	29.322	48.449	24.939
106°	94°00'	17	18.230	27.890	12°00'	140	14.715	29.322	48.904	25.236
107°	95°00'	17	18.552	28.157	12°00'	140	14.715	29.322	49.370	25.785
108°	96°00'	17	18.880	28.484	12°00'	140	14.715	29.322	49.845	26.224
109°	97°00'	17	19.215	28.780	12°00'	140	14.715	29.322	50.333	26.676
110°	98°00'	16	18.406	27.367	12°00'	150	15.766	31.416	51.777	25.967

Table E6-5

**TWO-CENTRE COMPOUND CURVES
FOR DESIGN VEHICLE WB-17.5
STOP CONDITION FROM SIDE ROAD TO MAIN HIGHWAY
ON TANGENT ALIGNMENT**

Δ	Δ ₂	R ₂	T ₂	L ₂	Δ ₁	R ₁	T ₁	L ₁	a	b
70°	55°00'	22	11.452	21.118	15°00'	110	14.482	28.798	37.089	18.595
71°	56°00'	22	11.698	21.502	15°00'	110	14.482	28.798	37.436	18.864
72°	57°00'	21	11.402	20.892	15°00'	110	14.482	28.798	37.307	18.446
73°	58°00'	21	11.640	21.258	15°00'	110	14.482	28.798	37.647	18.710
74°	59°00'	21	11.881	21.625	15°00'	110	14.482	28.798	37.990	18.979
75°	60°00'	20	11.547	20.944	15°00'	110	14.482	28.798	37.819	18.521
76°	61°00'	20	11.781	21.293	15°00'	110	14.482	28.798	38.155	18.786
77°	62°00'	20	12.017	21.642	15°00'	110	14.482	28.798	38.494	19.056
78°	63°00'	19	11.643	20.892	15°00'	110	14.482	28.798	38.279	18.556
79°	64°00'	19	11.873	21.223	15°00'	110	14.482	28.798	38.612	18.821
80°	65°00'	19	12.104	21.555	15°00'	110	14.482	28.798	38.949	19.091
81°	66°00'	19	12.339	21.886	15°00'	110	14.482	28.798	39.289	19.367
82°	67°00'	19	12.576	22.218	15°00'	110	14.482	28.798	39.633	19.648
83°	68°00'	19	12.816	22.550	15°00'	110	14.482	28.798	39.982	19.934
84°	69°00'	18	12.371	21.677	15°00'	110	14.482	28.798	39.689	19.359
85°	70°00'	18	12.604	21.991	15°00'	110	14.482	28.798	40.031	19.641
86°	71°00'	18	12.839	22.305	15°00'	110	14.482	28.798	40.337	19.928
87°	72°00'	18	13.078	22.619	15°00'	110	14.482	28.798	40.728	20.220
88°	73°00'	18	13.319	22.934	15°00'	110	14.482	28.798	41.084	20.519
89°	74°00'	18	13.564	23.248	15°00'	110	14.482	28.798	41.445	20.824
90°	75°00'	18	13.812	23.562	15°00'	110	14.482	28.798	41.812	21.135
91°	76°00'	17	13.282	22.550	15°00'	110	14.482	28.798	41.425	20.469
92°	77°00'	17	13.522	22.846	15°00'	110	14.482	28.798	41.785	20.775
93°	78°00'	17	13.766	23.143	15°00'	110	14.482	28.798	42.151	21.088
94°	79°00'	17	14.014	23.440	15°00'	110	14.482	28.798	42.522	21.407
95°	80°00'	16	13.426	22.340	15°00'	110	14.482	28.798	42.070	20.676
96°	81°00'	16	13.665	22.619	15°00'	110	14.482	28.798	42.435	20.990
97°	82°00'	16	13.909	22.899	15°00'	110	14.482	28.798	42.807	21.312
98°	83°00'	16	14.156	23.178	15°00'	110	14.482	28.798	43.185	21.640
99°	84°00'	16	14.406	23.457	15°00'	110	14.482	28.798	43.570	21.976
100°	85°00'	15	13.745	22.253	15°00'	120	15.798	31.416	45.683	21.509
101°	86°04'	15	14.004	22.532	14°56'	120	15.727	31.276	45.944	21.809
102°	87°08'	15	14.268	22.811	14°52'	120	15.656	31.137	46.210	22.117
103°	88°12'	15	14.536	23.091	14°48'	120	15.585	30.997	46.483	22.433
104°	89°16'	15	14.809	23.370	14°44'	120	15.514	30.857	46.763	22.757
105°	90°20'	15	15.088	23.644	14°40'	120	15.443	30.718	47.055	23.091
106°	91°30'	15	15.398	23.955	14°30'	120	15.266	30.369	47.155	23.385
107°	92°40'	15	15.715	24.260	14°20'	120	15.089	30.020	47.265	23.689
108°	93°50'	15	16.039	24.556	14°10'	120	14.911	29.671	47.381	24.004
109°	95°00'	15	16.370	24.871	14°00'	120	14.734	29.322	47.505	24.328
110°	96°10'	15	16.708	25.176	13°50'	120	14.557	28.972	47.636	24.663

Table E6-6

**TWO-CENTRE COMPOUND CURVES
FOR DESIGN VEHICLE WB-17.5
YIELD CONDITION TANGENT ALIGNMENT**

Δ	Δ ₂	R ₂	T ₂	L ₂	Δ ₁	R ₁	T ₁	L ₁	a	b
70°	58°00'	24	13.303	24.295	12°00'	130	13.664	27.227	38.001	19.270
71°	59°00'	24	13.579	24.714	12°00'	130	13.664	27.227	28.361	19.570
72°	60°00'	23	13.279	24.086	12°00'	130	13.664	27.227	38.198	19.169
73°	61°00'	23	13.548	24.487	12°00'	130	13.664	27.227	38.552	19.464
74°	62°00'	23	13.820	24.880	12°00'	130	13.664	27.227	38.909	19.764
75°	63°00'	23	14.090	25.290	12°00'	130	13.664	27.227	39.269	20.069
76°	64°00'	23	14.372	25.691	12°00'	130	13.664	27.227	39.634	20.379
77°	65°00'	22	14.016	24.958	12°00'	130	13.664	27.227	39.410	19.922
78°	66°00'	22	14.287	25.342	12°00'	130	13.664	27.227	39.769	20.228
79°	67°00'	22	14.561	25.726	12°00'	130	13.664	27.227	40.132	20.539
80°	68°00'	22	14.839	26.110	12°00'	130	13.664	27.227	40.499	20.857
81°	69°00'	22	15.120	26.440	12°00'	130	13.664	27.227	40.871	21.179
82°	70°00'	22	15.405	26.878	12°00'	130	13.644	27.227	41.248	21.508
83°	71°00'	22	15.692	27.262	12°00'	130	13.664	27.227	41.629	21.841
84°	72°00'	22	15.984	27.646	12°00'	130	13.664	27.227	42.016	22.182
85°	73°00'	22	16.279	28.030	12°00'	130	13.664	27.227	42.407	22.528
86°	74°00'	21	15.825	27.122	12°00'	130	13.664	27.227	42.080	21.971
87°	75°00'	21	16.114	27.489	12°00'	130	13.664	27.227	42.467	22.314
88°	76°00'	21	16.407	27.855	12°00'	130	13.664	27.227	42.860	22.663
89°	77°00'	21	16.804	28.222	12°00'	130	13.664	27.227	43.258	23.019
90°	78°00'	21	17.005	28.588	12°00'	130	13.664	27.227	43.662	23.382
91°	79°00'	21	17.311	28.955	12°00'	130	13.664	27.227	44.075	23.752
92°	80°00'	21	17.621	29.322	12°00'	130	13.664	27.227	44.492	24.129
93°	81°00'	21	17.936	29.688	12°00'	130	13.664	27.227	44.918	24.515
94°	82°00'	21	18.255	30.055	12°00'	130	13.664	27.227	45.350	24.908
95°	83°00'	20	17.695	28.972	12°00'	130	13.664	27.227	44.908	24.239
96°	84°00'	20	18.008	29.322	12°00'	130	13.664	27.227	45.336	24.629
97°	85°00'	19	17.410	28.187	12°00'	140	14.715	29.322	46.958	24.139
98°	86°00'	19	17.718	28.519	12°00'	140	14.715	29.322	47.387	24.527
99°	87°00'	19	18.030	28.050	12°00'	140	14.715	29.322	47.823	24.923
100°	88°00'	19	18.348	29.182	12°00'	140	14.715	29.322	48.267	25.328
101°	89°00'	19	18.671	29.514	12°00'	140	14.715	29.322	48.721	25.742
102°	90°00'	19	19.000	29.845	12°00'	140	14.715	29.322	48.430	26.010
103°	91°00'	19	19.335	30.177	12°00'	140	14.715	29.322	48.807	26.424
104°	92°00'	19	19.675	30.508	12°00'	140	14.715	29.322	50.136	27.044
105°	93°00'	19	20.022	30.840	12°00'	140	14.715	29.322	50.628	27.499
106°	94°00'	18	19.303	29.531	12°00'	140	14.715	29.322	50.018	26.661
107°	95°00'	18	19.644	29.845	12°00'	140	14.715	29.322	50.507	27.114
108°	96°00'	18	19.991	30.159	12°00'	140	14.715	29.322	51.007	27.578
109°	97°00'	18	20.345	30.473	12°00'	140	14.715	29.322	51.519	28.054
110°	98°00'	18	20.707	30.788	12°00'	140	14.715	29.322	52.043	28.544

E.7 OPEN THROAT WITH AUXILIARY LANES

Tapers and/or additional lanes may be provided for through and turning movements at simple open throat intersections thereby improving the capacity.

E.7.1 RIGHT TURN TAPER

To facilitate right turns from a main highway onto a minor local road such as a township road, having a 'Cross' or 'T' intersection treatment, a 60 m taper may be added, as shown in Figures E7-1 and E7-2. This taper is not added in every case. A factor such as the gravel soilage justifies the addition of a 60 m taper. However the 60 m taper is of sufficient length for deceleration, where the operating speed is 60 km/h or less. For speeds greater than 60 km/h, the

deceleration of the turning vehicles will start on the through lane. Where the turning vehicles significantly impede the through traffic flow, consideration should be given to the design as outlined in Section E.7.2.

At cross intersections a 30 m recovery taper with a 1.5m offset should be applied beyond the intersection when a right turn taper is used on a two lane highway, as shown in Figure E7-2. This enables vehicles on the main highway to pass standing left turning vehicles and safely return to the through lane.

The 30 m taper is to be used only on two lane highways. It is not required on four lane highways, at 'T' intersections or where the standard left turn lane has been provided.

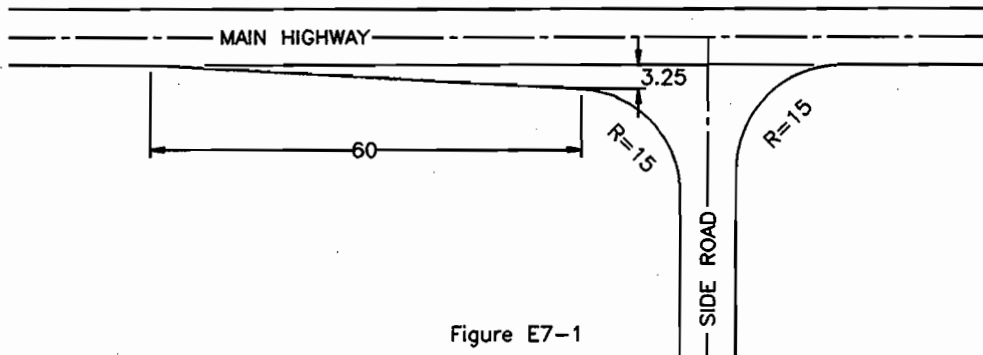

Figure E7-1

Right Turn Taper Lane Design at 'T' Intersections

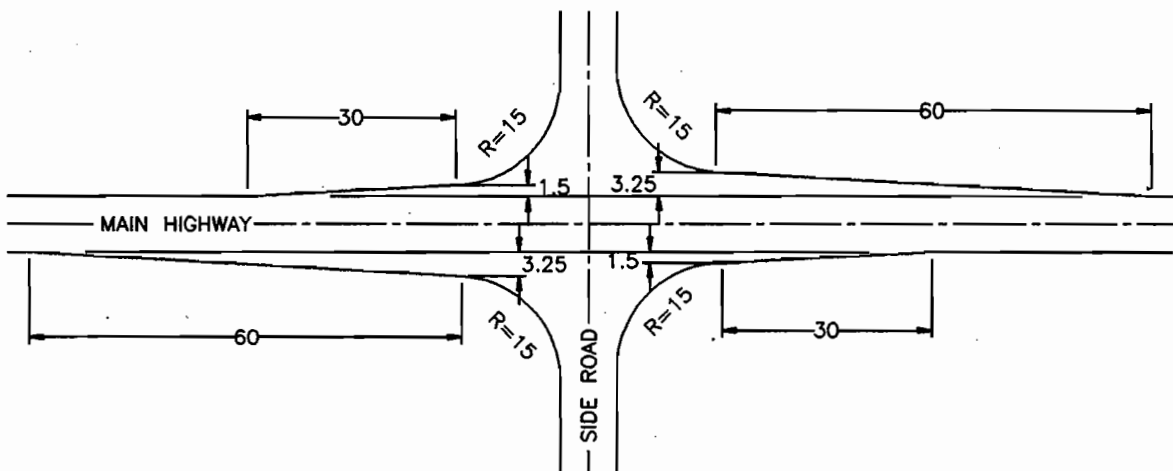

Figure E7-2

Right Turn Taper Lane Design at 'Cross' Intersections

E.7.2 RIGHT TURN TAPER WITH PARALLEL LANE

When the volume of right turning vehicles is such that it creates a hazard and reduces capacity at an intersection, or when the volume approaches the channelization criteria, as outlined in Sub-Chapter E.8, consideration should be given to the provision of a deceleration lane in the form of a taper and parallel lane for the right turning traffic, as shown in Figure E7-3.

The lengths of the taper and the parallel lane for various design speeds are given in Table E7-1. The

taper length is derived from design values calculated at a 3 s lane change criterion for the appropriate operating speed.

For grades greater than 2%, the length of deceleration lane should be corrected according to the factors shown in Table E7-2. The correction is applied by multiplying the total deceleration lane by the appropriate factor. The resultant deceleration length will comprise the total deceleration lane. The length of taper remains as shown in Table E7-1.

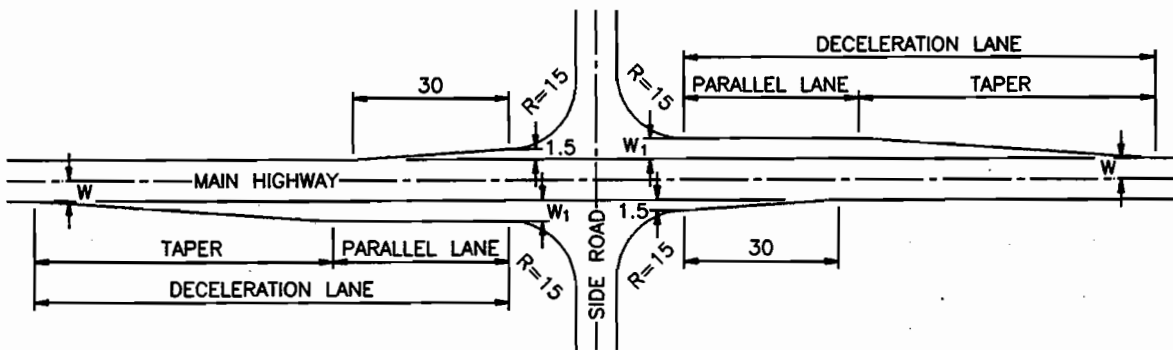

Figure E7-3

Right Turn Taper with Parallel Deceleration Lane Design

Highway Design Speed (km/h)	Length of Taper (m)	Length of Parallel Lane (m)	Total Length of Deceleration Lane (m)
50	40	20	60
60	50	30	80
70	60	45	105
80	70	60	130
90	75	70	145
100	80	85	165
110	85	100	185
120	90	110	200

Table E7-1

Right Turn Taper with Parallel Deceleration Lane Lengths
Flat Grades 2% or Less

ALL DESIGN SPEEDS	DOWN GRADE %	GRADE FACTOR > 1	UP GRADE %	GRADE FACTOR > 1
	8 - 7	1.5	2 - 3	1.0
	7 - 6	1.4	3 - 4	0.9
	6 - 5	1.4	4 - 5	0.9
	5 - 4	1.3	5 - 6	0.8
	4 - 3	1.2	6 - 7	0.8
	3 - 2	1.1	7 - 8	0.7

Table E7-2

**Grade Factors
for Deceleration Length**

The width of the parallel lane (w_1) should be 0.25 m less than the width of the through lane (w), but not less than 3.25 m, see Figure E7-3.

Similar to the right turn taper design, a 30 m recovery taper with a 1.5 m offset should be applied beyond the intersection when using the taper and parallel lane design on two-lane highways, see Figure E7-3. It is not required on a 4-lane highway, at 'T' intersections or where a left turn lane has been provided.

E.8 RIGHT TURN LANES AT CHANNELIZED INTERSECTIONS

Right turn lanes forming channelized intersections may be constructed when the following criteria apply:

right turning traffic volumes for the design hour is 60 vehicles per hour or more,

property is readily available, and

the terminal points of the deceleration/acceleration lanes do not conflict with any adjacent commercial development.

In congested urban areas, the right turn directional island is considered to be of little value since the vehicles on the ramp have difficulty merging with the traffic on the intersecting road when that traffic is moving on its green signal phase.

Conflicts can occur between vehicles and pedestrians at these high volume locations, leading to the conclusion that right turn directional islands should not be constructed at such locations. However, in those areas where there may be some pedestrian traffic, the right turn channelization island has a definite bearing on the need for, and operation of, traffic signals.

E.8.1 DECELERATION TAPER

A deceleration taper is provided in advance of a separate turn lane or ramp at channelized intersection permitting a gradual change in speed from that of the highway to that of the channelized ramp alignment, see Figure E8-1.

The taper form is used where the required deceleration length is equal to or less than 180 m, see Table E8-1. When the deceleration length exceeds 180 m, a parallel lane with taper design is used.

The length of deceleration taper is measured to the bullnose and varies directly with the speed on the highway and inversely to the speed of the ramp. The adjustment for the grade must be applied as outlined in Section E.8.5.

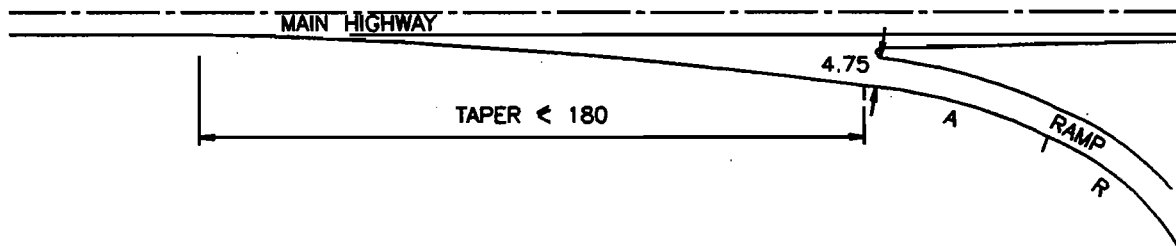

Figure E8-1

Deceleration Taper at Channelized Intersections

Table E8-1

TOTAL DECELERATION LANE LENGTHS
Flat Grades 2% or less

DESIGN SPEED OF RAMP, (km/h)	30	35	40	50
MINIMUM CURVE RADIUS,(m)	25	30	45	80
HIGHWAY DESIGN SPEED (km/h)	Deceleration Taper or Deceleration Lane including Taper			
50	55	45	40	--
60	75	70	60	50
70	100	95	85	70
80	125	115	110	95
90	140	135	130	115
100	160	155	150	135
110	180	175	170	155
120	195	190	185	170

Above the heavy line - taper design.
Below the heavy line - parallel lane with taper design applies.

E.8.2 PARALLEL DECELERATION LANE WITH TAPER

If deceleration lane lengths greater than 180 m are required then a parallel lane with a taper is used to provide a gradual change in speed from that of the highway to that of the ramp alignment at the channelized intersection, see Figure E8-2.

The taper length is derived from design values calculated at a 3 s lane change criterion for the appropriate operating speed.

The taper length values for various design speeds are given in Table E8-2.

The minimum parallel lane length is 15 m and is transitioned to the ramp using a curve with a radius in the range of 600 m to 900 m. The parallel lane width should be 0.25 m less than the width of the through pavement, and should not be less than 3.25 m.

The total length of the deceleration lane is measured to the bullnose and varies directly with the speed on the highway and inversely to the speed of the ramp, see Table E8-1.

Note for speeds of 70 km/h or less, deceleration requirements will not exceed 180 m including the grade factor, therefore the total deceleration lane will be in the form of a taper, see Figure E8-1.

Table E8-2

Taper Length for Parallel Lane Design

Highway Design Speed (km/h)	60	70	80	90	100	110	120
Taper Length (m)	50	60	70	75	80	85	90

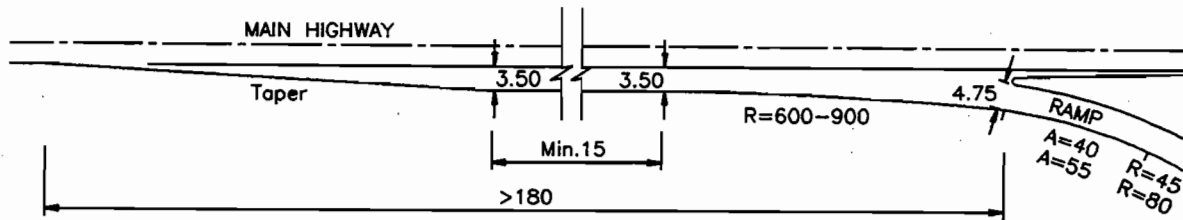

Figure E8-2

Parallel Deceleration Lane with Taper at Channelized Intersections

For the application of the grade factor in the design of a deceleration lane use Table E8-5 in conjunction with Table E8-1, as outlined in Section E.8.5.

E.8.3 ACCELERATION TAPER

An acceleration taper is provided beyond the separate turn lane or ramp to permit a vehicle entering the highway to accelerate to the speed of the through vehicles on the highway before merging, see Figure E8-3.

The taper form is used where required acceleration length is equal to or less than 180 m. Two separate tables may be referred to in order to obtain the

required length, depending on whether the highway is carrying traffic volume less or more than 400 vehicles per hour/per lane, see Table E8-3 and E8-4.

Where acceleration lane lengths exceed 180 m or where additional lengths are required due to the effect of grade resulting in lengths greater than 180 m, a parallel acceleration lane with taper design shall be applied.

The length of the acceleration taper is measured from the bullnose and varies directly with the speed of the highway and the highway traffic volume and inversely to the speed of the ramp. The adjustment for grade must be applied as outlined in Section E.8.5.

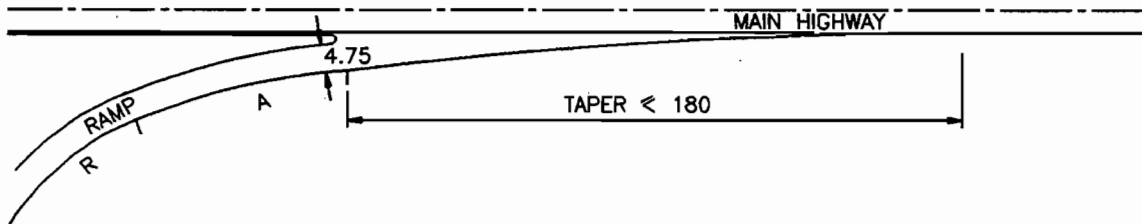

Figure E8-3

Acceleration Taper at Channelized Intersections

TABLE E8-3
TOTAL ACCELERATION LANE LENGTHS
HIGHWAY VOLUME LESS THAN 400 VPH/LANE
Flat grades 2% or less

DESIGN SPEED OF RAMP, (km/h)	30	35	40	50
MINIMUM CURVE RADIUS, (m)	25	30	45	80
HIGHWAY DESIGN SPEED (km/h)	Acceleration Taper or Acceleration Lane including Taper			
50	40	--	--	--
60	50	50	50	--
70	90	80	70	60
80	135	125	115	85
90	190	180	170	145
100	255	245	235	210
110	330	320	310	280
120	420	410	400	370

Above the heavy line - taper design applies.
 Below the heavy line - parallel lane with taper design applies.

E.8.4 PARALLEL ACCELERATION LANE WITH TAPER

An acceleration lane with taper is provided beyond the separate turn lane to permit a vehicle entering the highway to accelerate to the speed of the through vehicles of the highway before merging, see Figure E8-4.

The taper length is derived from design values calculate at a 3 s lane change criterion for the appropriate operating speed.

The taper length values for various design speeds are shown in Table E8-2.

Acceleration lanes with lengths greater than 180 m are comprised of circular curves using the radius in the range of 900 m to 1000 m, a section of parallel lane length of 15 m minimum and a taper, see Figure E8-4.

The width of the parallel lane is 0.25 m less than the through lane width with a minimum of 3.25 m. Acceleration lanes with lengths of 180 m or less take the form of a taper only. see Figure E8-3.

The length of the acceleration lane and taper is measured from the bullnose and varies directly with the speed of the highway, and the traffic volume on the highway and inversely to the speed of the ramp. The adjustment for grade must be applied as outlined in Section E.8.5.

Tables E8-3 and E8-4 may be referred to in order to obtain the required length, depending on highway traffic volumes.

For light volumes, less than 400 vph per lane, the values are taken from Table E8-3. For heavy volumes, greater than 400 vph per lane, the values are taken from Table E8-4.

Table E8-4

**TOTAL ACCELERATION LANE LENGTHS
HIGHWAY VOLUME GREATER THAN 400 VPH/LANE
Flat grades 2% or less**

DESIGN SPEED OF RAMP, (km/h)	30	35	40	50
MINIMUM CURVE RADIUS, (m)	25	30	45	80
HIGHWAY DESIGN SPEED (km/h)	Acceleration Taper or Acceleration Lane including Taper			
50	40	40	--	--
60	65	60	50	50
70	115	105	95	65
80	170	160	150	120
90	230	220	210	180
100	305	295	285	255
110	390	380	370	340
120	495	485	475	445

Above the heavy line - taper design.
Below the heavy line - parallel lane with taper design.

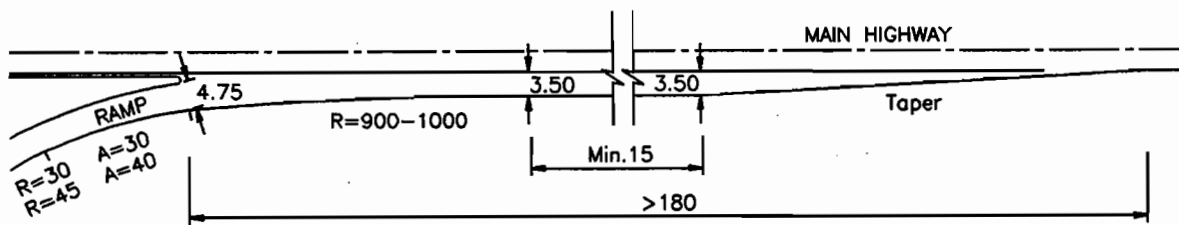

Figure E8-4

Parallel Acceleration Lane With Taper at Channelized Intersections

E.8.5 EFFECT OF GRADE

The design values of deceleration and acceleration lane lengths are based on approximately level grades. As the grades influence deceleration, stopping and acceleration distances, the design values for level conditions require correction when applied on grades higher than 2% to produce conditions equivalent to those on the level sections of the roadway.

Upgrades decrease the lengths of deceleration lanes and increase the lengths of acceleration lanes, while downgrades have the opposite effect. For grades higher than 2%, the length of speed change lane should be corrected according to the grade factors shown in table E8-5.

The correction is applied by multiplying the sum of the parallel portion and the taper portion of the speed

change lane with the appropriate grade factor. The resultant length comprised the new required total speed change lane length and includes the original standard taper length which remains unchanged for all grade values.

When the speed change lane consists of a taper only, then the taper length is multiplied by the grade factor and the obtained value is the new taper length providing that it does not exceed 180 m.

Most vehicle operators are unable to judge the increase or decrease in deceleration or acceleration distance that is necessary because of grades. Their normal decisions and reactions therefore may be in error at a critical time, particularly approaching intersection conflict areas. Accordingly, grades in excess of 3% should be avoided on intersecting roadways.

Table E8-5

GRADE FACTORS FOR DECELERATION AND ACCELERATION LANES

DECELERATION LANES							
Design speed of Highway (km/h)	Ratio of Length on Grade to Length on Level for:						
All Speeds	3 to 4% Upgrade 0.9					3 to 4% Downgrade 1.2	
All Speeds	5 to 6% Upgrade 0.8					5 to 6% Downgrade 1.4	
ACCELERATION LANES							
Design Speed of Highway (km/h)	Ratio of Length on Grade to Length on Level for: Design Speed of Ramp (km/h)						
	30	40	50	60	70	80 *	All Speeds
	3 to 4% Upgrade						3 to 4% Downgrade
50	1.3	1.3	-	-	-	-	0.7
60	1.3	1.3	1.3	-	-	-	0.7
70	1.3	1.3	1.4	1.4	-	-	0.7
80	1.4	1.4	1.4	1.4	1.5	-	0.7
90	1.4	1.4	1.5	1.5	1.5	1.5	0.7
100	1.4	1.5	1.5	1.5	1.6	1.6	0.6
110	1.5	1.5	1.6	1.6	1.7	1.7	0.6
120	1.5	1.6	1.6	1.7	1.7	1.8	0.6
	5 to 6% Upgrade						5 to 6% Downgrade
50	1.5	1.5	-	-	-	-	0.6
60	1.5	1.5	1.5	-	-	-	0.6
70	1.6	1.6	1.7	1.7	-	-	0.6
80	1.7	1.7	1.8	1.9	1.9	-	0.6
90	1.8	1.9	2.0	2.1	2.1	2.3	0.6
100	1.8	2.0	2.1	2.3	2.4	2.5	0.5
110	1.9	2.1	2.3	2.4	2.6	2.8	0.5
120	2.0	2.2	2.4	2.6	2.8	2.8	0.5

For grades between 2%, 3%, 4%, 5%, 6% and over interpolation is to be used to determine suitable ratio values.

* Grade factors for high ramp design speeds are also applicable to interchange design.

E.8.6 YIELD TAPER AT SIDE ROAD

A 60 m yield taper may be used for stop or acceleration and merge purposes at the side road.

- a) in low speed urban areas, and on side roads carrying light traffic volumes, and

- b) at channelized 'T' intersections, or cross intersections with stop sign control, where side road traffic stops and traffic turning from the highway does so at low speeds. See Figure E8-5.

At channelized, signalized, rural intersections having high speed through traffic, full acceleration lane lengths should be applied to both roads wherever possible.

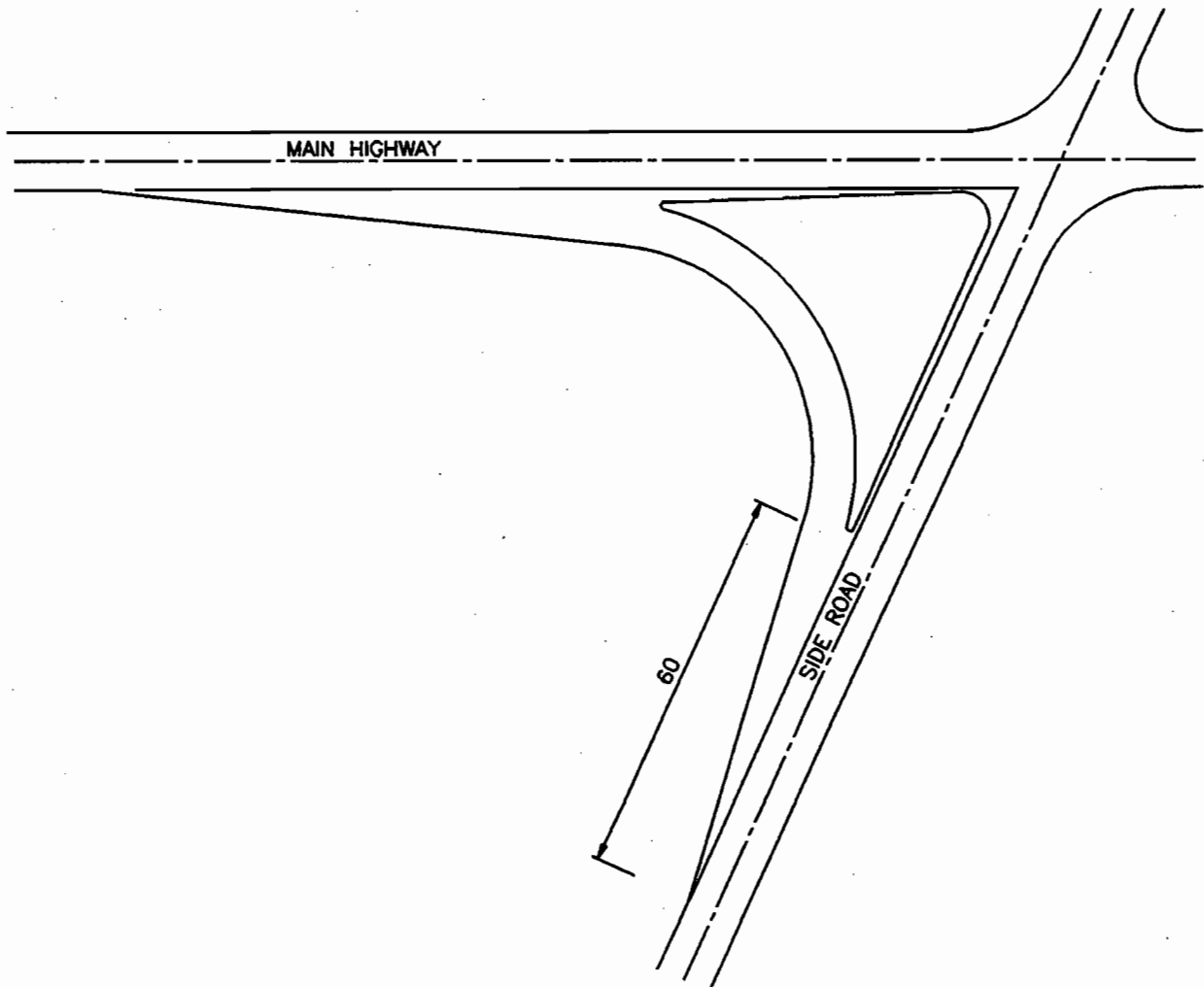

Figure E8-5

Yield Taper at Channelized Intersections
Main Highway to Side Road

E.8.7 RAMP DESIGN FOR CHANNELIZED INTERSECTIONS

The term ramp includes diverse types, arrangements and sizes of turning lanes or turning roadways that connect intersecting roads or highways.

Generally the ramp as applied in the at-grade intersection design is a one-way, one-lane roadway from the end of the deceleration lane at the exit terminal to the beginning of the acceleration lane at the entrance terminal.

The ramp alignment consists of:

- a) A circular curve, or
- b) a spiralled circular curve.

The general shape of the ramp evolves from the type of alignment selected.

The alignment control of the ramp proper is the inside edge of the pavement. See Table E8-6 for the recommended design data.

E.8.8 CIRCULAR CURVES

The size of a circular curve, with or without spirals, varies depending on the conditions under which it is applied. To design a turning lane from a main highway to a side road, a 45 m or 80 m radius curve is used for a ramp design speed of 40 km/h or 50 km/h respectively.

For a turning lane from a side road to a main highway, a 30 m radius curve is used for a ramp design speed of 35 km/h. However, a 45 m radius curve may be considered if the turning volumes are particularly heavy.

In situations where the intersection configuration produces small deflection angles of the ramp alignment an 80 m radius curve should be used for 50 km/h design speed from the highway or the side road.

In urban locations where property presents a problem and highway speeds are low, for a design speed of 30 km/h a radius of 25 m may be used without spirals. See Figure E8-6.

TABLE E8-6

RECOMMENDED CURVE RADII, SPIRAL PARAMETERS AND SUPERELEVATION FOR CHANNELIZATION RAMP DESIGN

DESIGN SPEED OF HIGHWAY (km/h)	50 to 110			
	From Highway to Side Road		From Side Road to Highway	
DESIGN SPEED OF RAMP (km/h)	40	50	35	30
RADIUS OF RAMP (m)	45	80	30 or 45 ⁽¹⁾	25
SPIRAL PARAMETER (m)	40	55	30	0
MAXIMUM SUPERELEVATION RATE ⁽²⁾ (m/m)	0.06		0.06	

Notes :

- (1) A 45 m radius is used if the turning volumes are heavy.
- (2) Superelevation rates of less than the maximum are acceptable when site conditions limit the superelevation to less than the maximum rate.

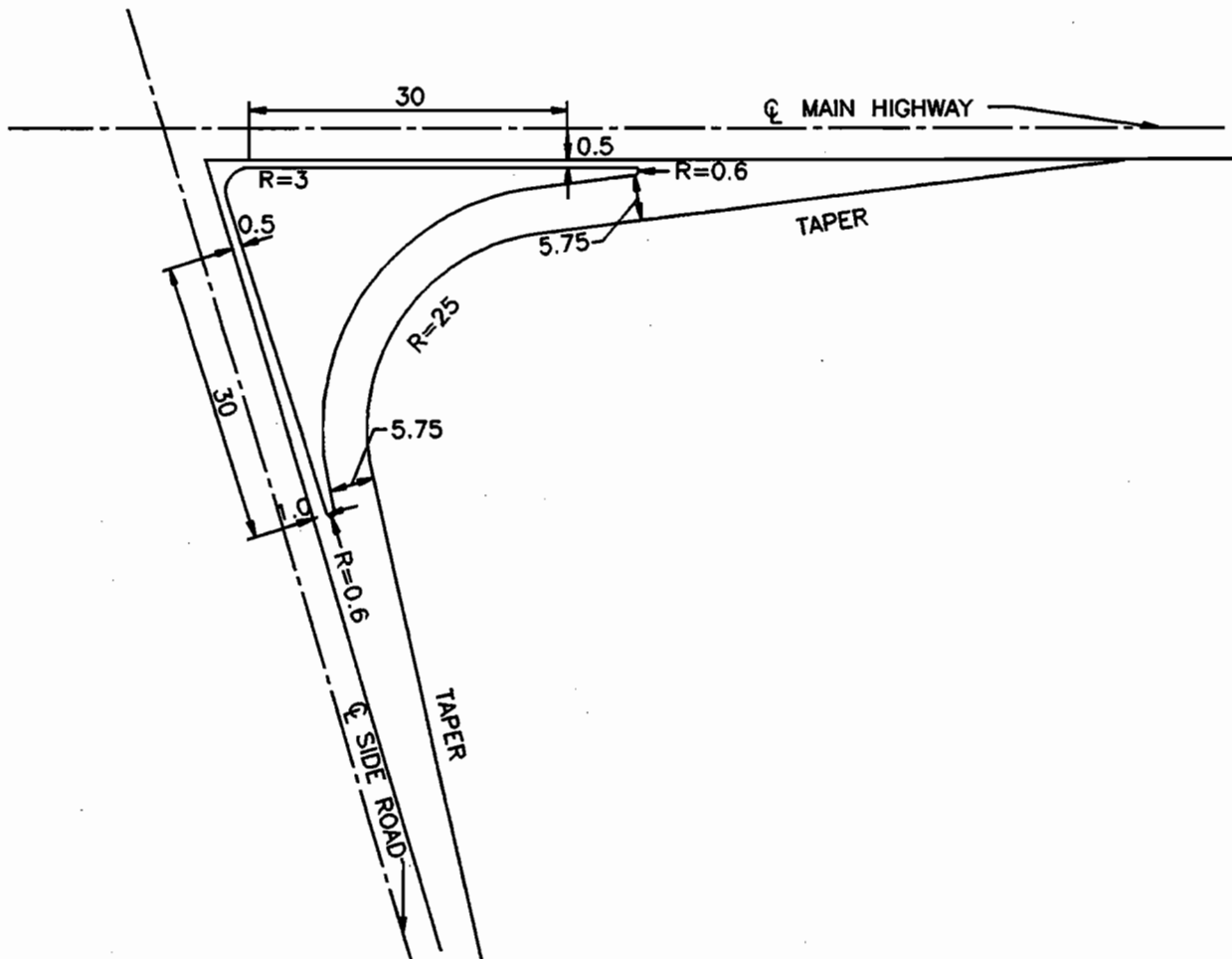

Figure E8-6

Ramp Design without Spirals
Side Road to Main Highway

E.8.9 SPIRALLED CIRCULAR CURVES

Spirals are usually provided at the beginning and end of the simple circular curve to provide a smooth transition

- (a) between the curve and the adjoining tangent or curve,
- (b) throughout the ramp pavement widening when necessary, and
- (c) for attaining superelevation on the curve.

The spiral length varies for different curve radii.

Most channelizations are designed with 30 m or 45 m radius curves and with spirals of $A = 30$ or $A = 40$.

See Figure E8-7. However, where an 80 m radius curve is designed, a spiral parameter of $A = 55$ may be used.

Island bullnoses should be located at the beginning of the first spiral and at the end of the second spiral. In situations where property presents a problem, the bullnoses may be located at the mid-points of the spirals. The superelevation runoff is normally applied within the length of spiral.

Where the right of way is very limited and a separate right turn lane is warranted, a transition throughout as a design alternative may be considered. Here the two spirals are joined at spiral-curve-spiral (S.C.S) point and the nominal circular curve, $L_c = 0$, is used for the computation of spiral components only.

For circular and spiral curve nomenclature and derivation of formulae refer to the Ministry publication "CIRCULAR AND SPIRAL CURVE FUNCTIONS".

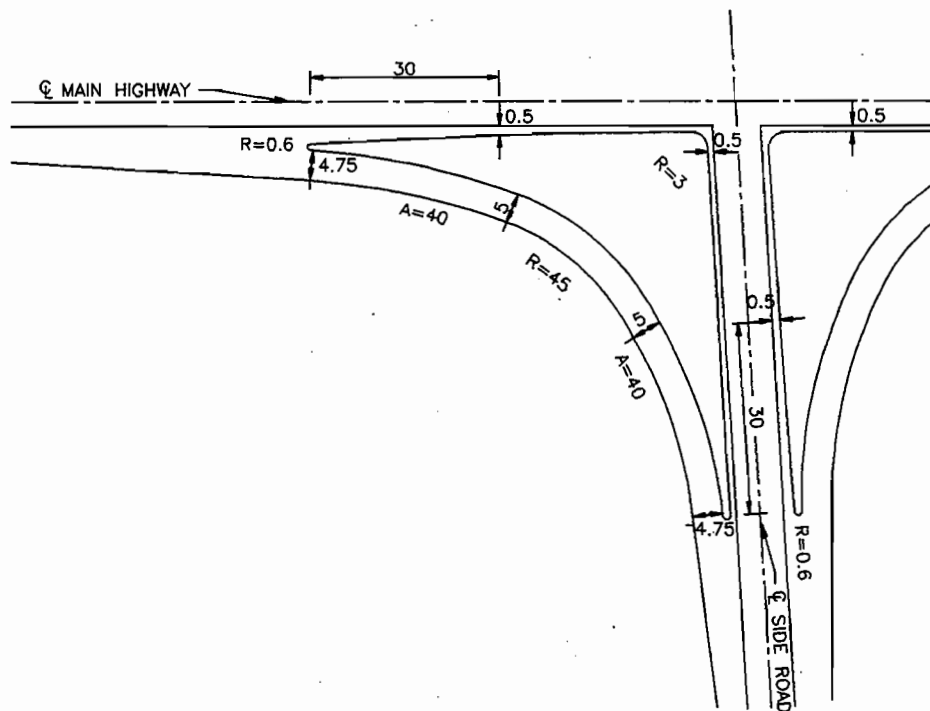

Figure E8-7
Ramp Design with Spirals
Main Highway to Side Road

E.8.10 APPROACH-END BULLNOSE AT EXIT TERMINALS

Approach bullnoses of islands with separate turn lanes should have mountable type curbing. The bullnoses should be offset from the edges of the through traffic lane in order to funnel drivers smoothly into the desired path and to provide an area for a recovery manoeuvre. See Figure E8-8. Failure to offset approach-end bullnoses can make an island appear more restrictive than it actually is and can have a psychological effect on drivers, causing them to make erratic movements as they approach the intersection. Bullnoses are not offset on the side adjacent to the separate turning lane as the minimum 4.75 m lane width provides sufficient clearance to the island.

Offset dimensions for approach bullnoses on channelizing islands should be in relation to the design speed, see Table E8-7. The offset is tapered to 0.5 m from the approach bullnose, and is applied to the remainder of the island. Where there are islands both in advance of and beyond an intersection, only the bullnose on the advance island needs to be offset. The second island offset is 0.5 m for the entire length, see Figure E8-7.

If a separate right turn lane and directional island is not required in advance of the intersection, then the island beyond the intersection is provided with the standard offset as applied to the approach-end bullnose, including the 30 m, see Figure E8-9.

For a side road with a stop control condition approach, the bullnose offset dimension should be 1.0 m for all design speeds. The offset is tapered to 0.5 m within 30 m from the approach bullnose and is applied to the remainder of the island, see Figure E8-9.

At signalized intersections the full standard bullnose offset is to be applied to both the main highway and side road, according to their respective design speeds.

Where the island length is less than 30 m the taper is not applied and the bullnose offset distance is carried for the full length of the island.

The offset provided by gutter section, when used will be in addition to the 0.5 m offset referred to above. Oversize offsets diminish the guiding effect of the island.

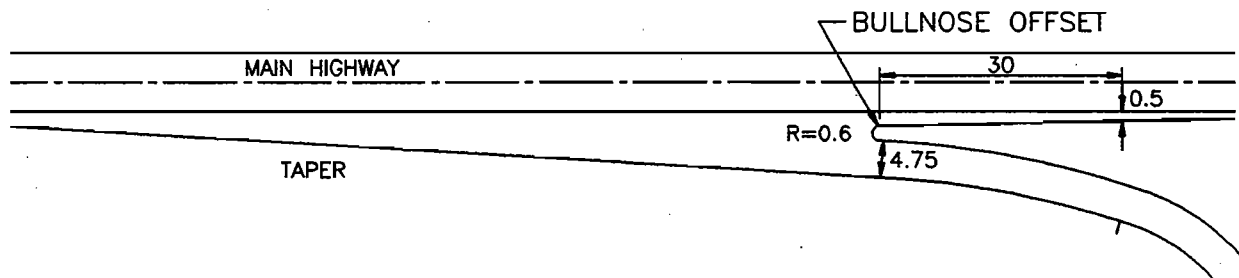

**Figure E8-8
Approach-End Design**

FREE FLOW / SIGNAL CONTROL									STOP CONTROL
HWY DESIGN SPEED km/h	50	60	70	80	90	100	110	120	ALL SPEEDS
OFFSET	1.0	1.2	1.4	1.6	1.8	2.0	2.2	2.4	1.0

**Table E8-7
BULLNOSE OFFSETS**

E.8.11 WIDTH OF PAVEMENT FOR RAMP DESIGN

The pavement width required on a separate right turn lane to accommodate the off-tracking of the wheels of a design vehicle increases as the radius decreases, see Table E8-8. Pavement widening, when required, is applied to the circular curve of the ramp. The minimum pavement width to be used is 4.75 m except under special circumstances.

On separate turn lanes with spirals, where extra width is required, the pavement width should be 4.75 m at the beginning of the first spiral and increased throughout the length of the spiral to reach its design width at the beginning of the circular curve. The design width is held throughout the curve, then diminishes to 4.75 m throughout the second spiral, see Figure E8-9.

Where no spirals are used, the required extra pavement width is applied uniformly throughout the circular curve, see Figure E8-6.

Table E8-8

DESIGN WIDTHS OF PAVEMENT FOR RAMP DESIGN

Radius on Inner Edge of Pavement R (m)	PAVEMENT WIDTH IN METRES FOR:								
	CASE I 1 Lane - 1 way operation - no provision for passing a stalled vehicle			CASE II 1 lane 1 way operation - with provision for passing a stalled vehicle			CASE III 2 lane operation - either one way or two way		
	Design Traffic Conditions								
	A	B	C*	A	B	C	A	B	C
20	5.50	5.50	7.00	7.00	7.75	8.75	9.50	10.75	13.00
25	4.75	5.00	5.75	6.50	7.00	8.25	8.75	10.00	11.50
30	4.50	4.75	5.50	6.00	6.75	7.75	8.50	9.50	10.75
40	4.25	4.75	5.25	6.00	6.75	7.50	8.50	9.25	10.50
45	4.25	4.75	5.00	6.00	6.50	7.25	8.50	9.00	10.25
50	4.25	4.75	5.00	6.00	6.50	7.25	8.25	9.00	10.00
60	4.00	4.75	4.75	5.75	6.50	7.00	8.25	8.75	9.50
80	4.00	4.75	4.75	5.75	6.25	7.00	8.25	8.75	9.25
100	4.00	4.50	4.75	5.50	6.25	6.75	8.00	8.50	9.00
125	4.00	4.50	4.75	5.50	6.00	6.75	8.00	8.50	8.75
150	3.75	4.50	4.50	5.50	6.00	6.75	8.00	8.25	8.75
TANGENT	3.75	4.50	4.50	5.00	5.75	6.50	7.75	7.75	8.25
Semi-mountable and Mountable Curbs	none			none			none		
Barrier Curbs; One Side Two Sides	add 0.25 m add 0.50 m			none add 0.25 m			add 0.25 m add 0.50 m		
Stabilized Shoulder; One or Both Sides	none			deduct shoulder width; minimum pavement width as under CASE I			deduct 0.50 m where shoulder is 1 m or wider		

TRAFFIC CONDITION A - Predominantly P vehicles, but some considerations for SU trucks.

TRAFFIC CONDITION B - Sufficient SU vehicles to govern design, but some condition for semitrailer vehicles.

TRAFFIC CONDITION C - Sufficient semitrailer, and semitrailer/trailer combinations WB-15 or WB-18 vehicles to govern design.

* CASE I, TRAFFIC CONDITION C is mostly applied to Ministry designs.

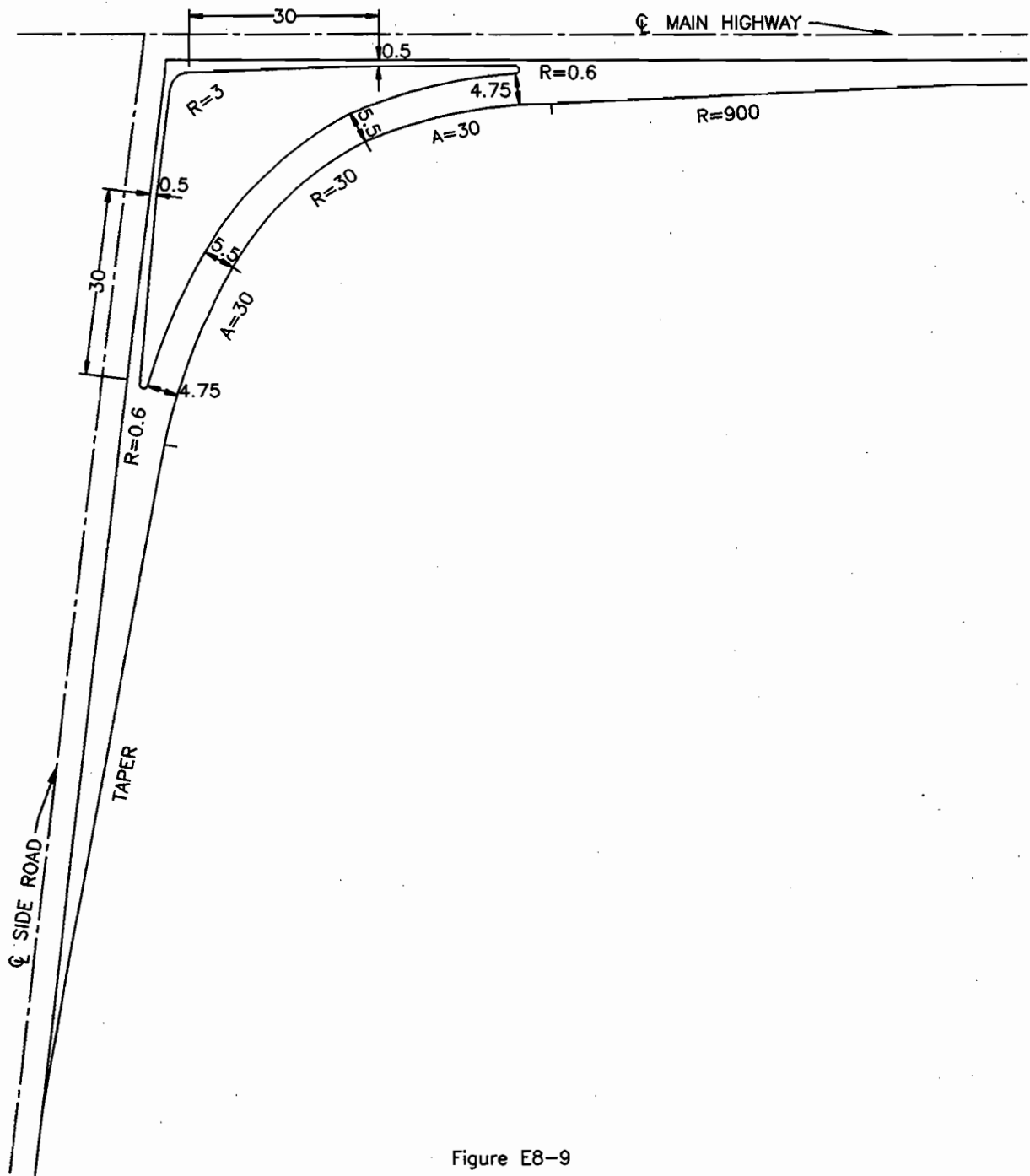

Figure E8-9

Ramp Design with Spirals and Pavement Widening
Side Road to Main Highway

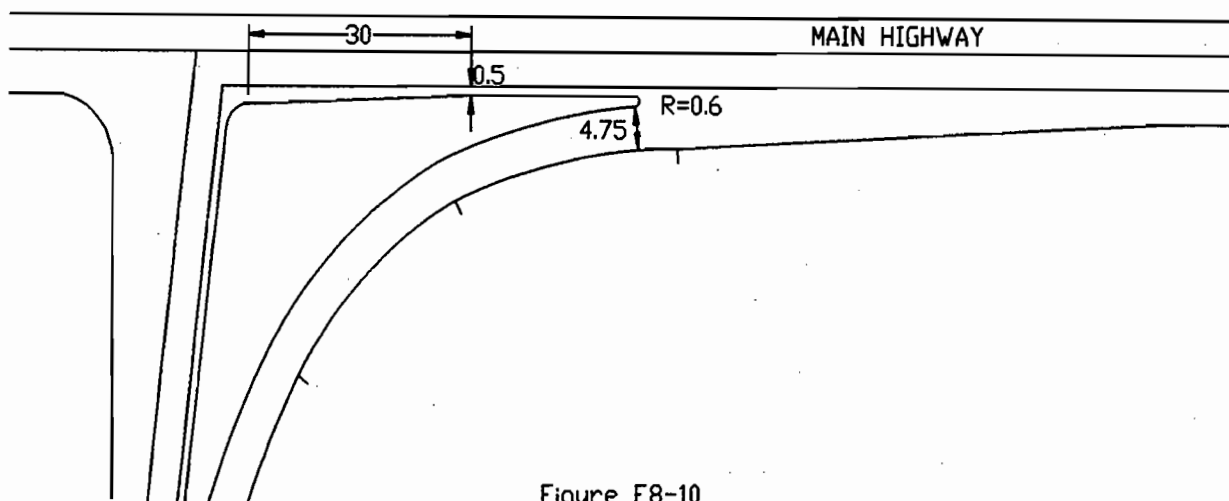

Figure E8-10

Merge-End Design

E.8.12 MERGE-END BULLNOSE AT ENTRANCE TERMINALS

The merging end of an island at the terminal of any turning roadway should be as small as practicable. A 0.5 m offset should be provided from the edge of pavement of the through traffic lane to the island and the merge bullnose. The bullnose is not offset on the side adjacent to the separate turning lane as the minimum 4.75 m lane width provides sufficient clearance to the island, see Figure E8-10. A barrier type curb is preferred at this location. It delineates and directs the drivers onto the proper acceleration lane.

E.8.13 BULLNOSE SIZE

Both the approach-end and the merge-end bullnose of the island should have a 0.6 m radius, including the curb and gutter.

E.8.14 DIRECTIONAL ISLANDS

The directional islands also called channelizing islands are formed in conjunction with a separate right turn lane design, see Figure E8-11. These control and direct traffic movements and guide the motorist into the proper channel.

The directional islands also serve as a refuge for the pedestrians crossing the intersection, and for the location of traffic signs and signals.

The design of the directional island is a direct result of the length of the deceleration/acceleration lanes in

combination with the circular curve and/or spirals of the ramp, pavement width and bullnose size and their offsets from the edge of the through lane.

Of particular significance is the bullnose location, i.e. beginning of spiral, or midpoint of spiral.

- Beginning of spiral design.

The approach-end bullnose at exit terminals is designed at the beginning of the ramp curve or spiral and at the merge-end bullnose at the end of the ramp curve or spiral at the entrance terminal for channelized intersections. This is the recommended Ministry's geometric design standard.

- Midpoint spiral design.

The midpoint spiral location can be tolerated for the approach-end and merge-end under restricted right-of-way conditions. The length of the island is thereby reduced by one half of the spiral length at both - the approach-end and the merge-end.

When designing an island it should be recognized that the driver's eye view is different from the plan view. Particular care should be taken where the channelization design is on or beyond a crest of a vertical curve, however slight, or where there is substantial horizontal curvature on the approach to or through the intersection area.

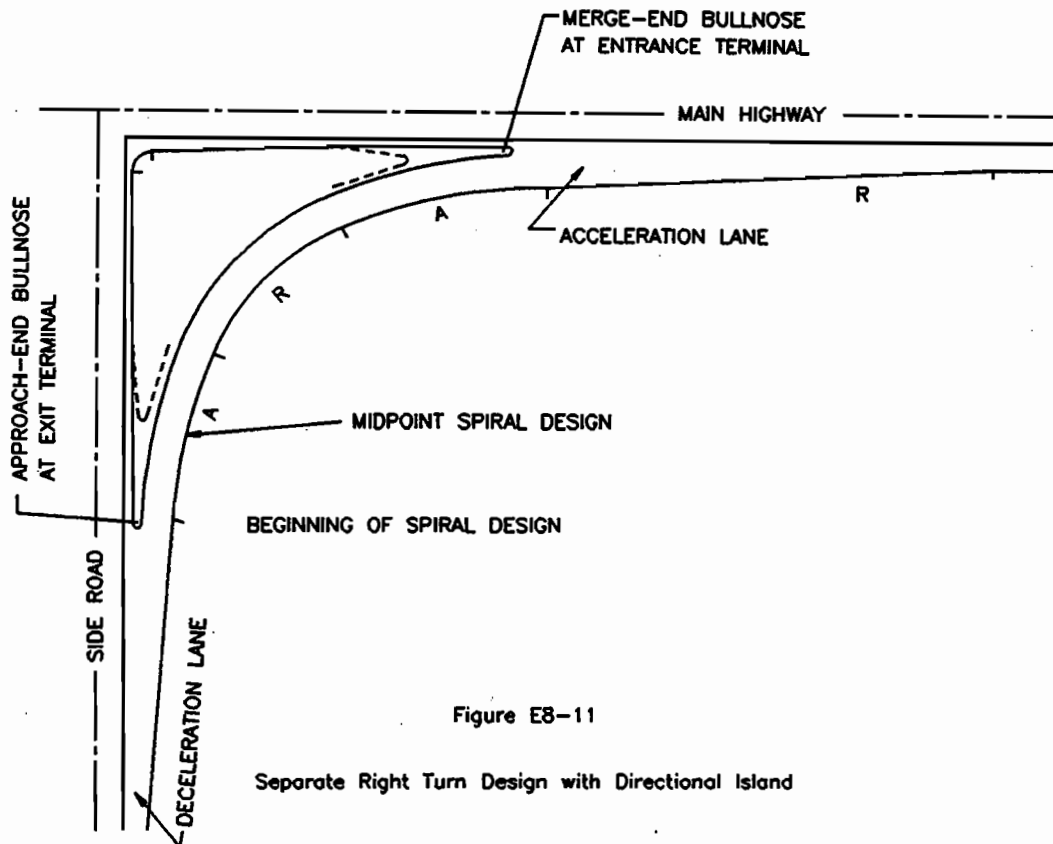

Figure E8-11

Separate Right Turn Design with Directional Island

E.8.14.1 Island Shape

The shape of the directional island is determined largely by the alignment of the intersecting roads and that of the separate right turn lane. However, every effort should be made to extend the merge bullnose in such a manner as to direct the merging vehicle to a path near-parallel to that of the through road, thereby encouraging full use of the acceleration lane, see Figure E8-9.

The design speed of the separate turn lane significantly affects the shape of the directional island.

The island is delineated either by a short radius curve without spirals for low design speeds or a curve with spirals for higher design speeds.

In the case of a skewed intersection that has been realigned and channelized, the bullnose on the side road should be located so as not to invite wrong way entry into the one-way separate turn lane. This may be accomplished by placing the bullnose beyond the curve and on the tangent portion of the roadway nearest the highway; see the preferred design in Figure E8-12.

Where the property restrictions prohibit the relocation and realignment of the side road resulting in a short radius curve and short tangent at the intersection, an acceptable design shown in Figure E8-13 could be applied. The bullnose is to be extended towards the beginning of the curve of the side road to block wrong way entry into the separate turn lane.

E.8.14.2 Island Size

The area of a triangular island should be preferably 10 m². The acceptable minimum standards are:

- 4.5 m² - urban intersections and
- 7.0 m² - rural intersections.

Accordingly, the sides of an island excluding rounding at the corners should be as follows:

- Urban intersections;
- 3.5 m preferably, and
- 3.0 m minimum and

- Rural intersections;
- 4.5 m preferably, and
- 3.75 m minimum.

E.8.15 CHANNELIZATION DESIGN; SUMMARY

Channelization design is a form of intersection treatment involving separate right turn lanes with islands to direct traffic movements into definite paths of travel.

For the criteria and functions, and principles of channelization design and islands, refer to Section E.2.7, Channelization design. For left turn lanes refer to Sub-Chapter E.9 and E.10.

Figure E8-14 shows a typical fully channelized intersection of two four-lane approaches.

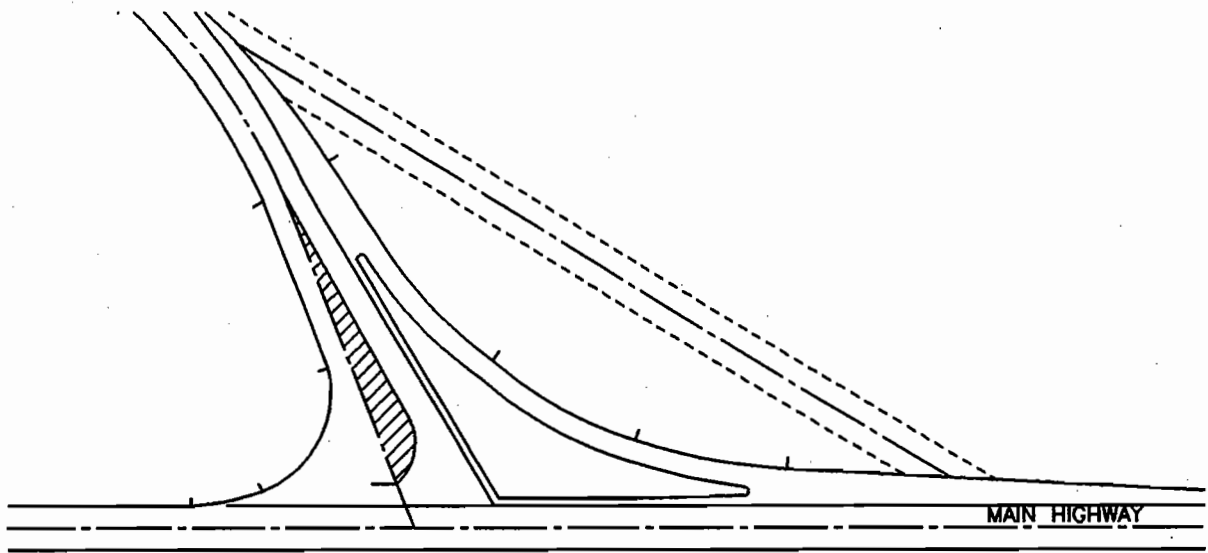

PREFERRED DESIGN

Figure E8-12

Design of Bullnose Location on Side Road

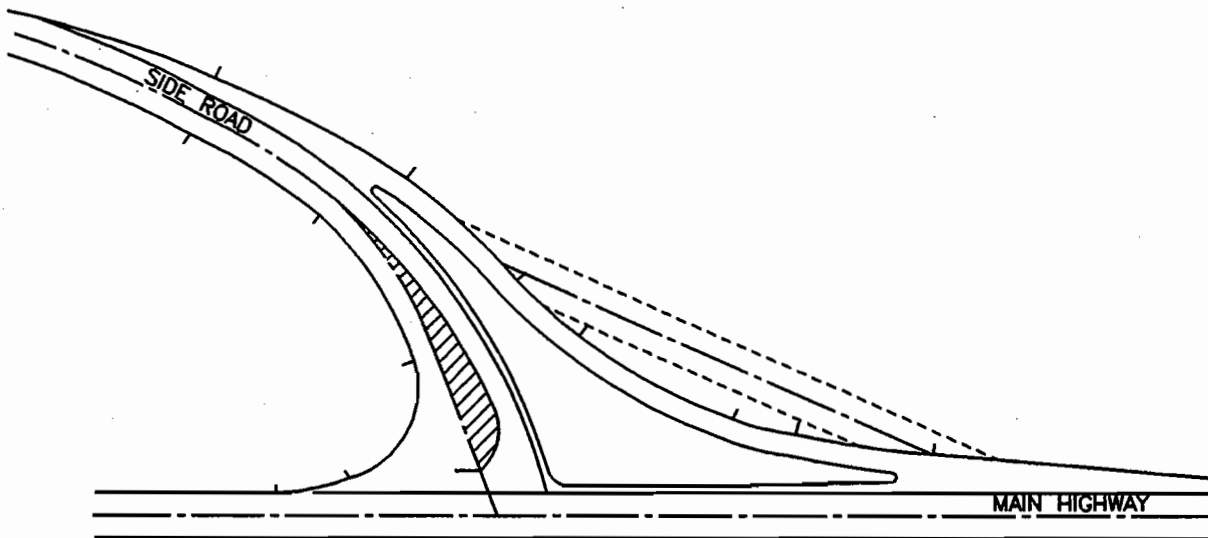

RESTRICTED PROPERTY

Figure E8-13

Design of Bullnose Location on Side Road

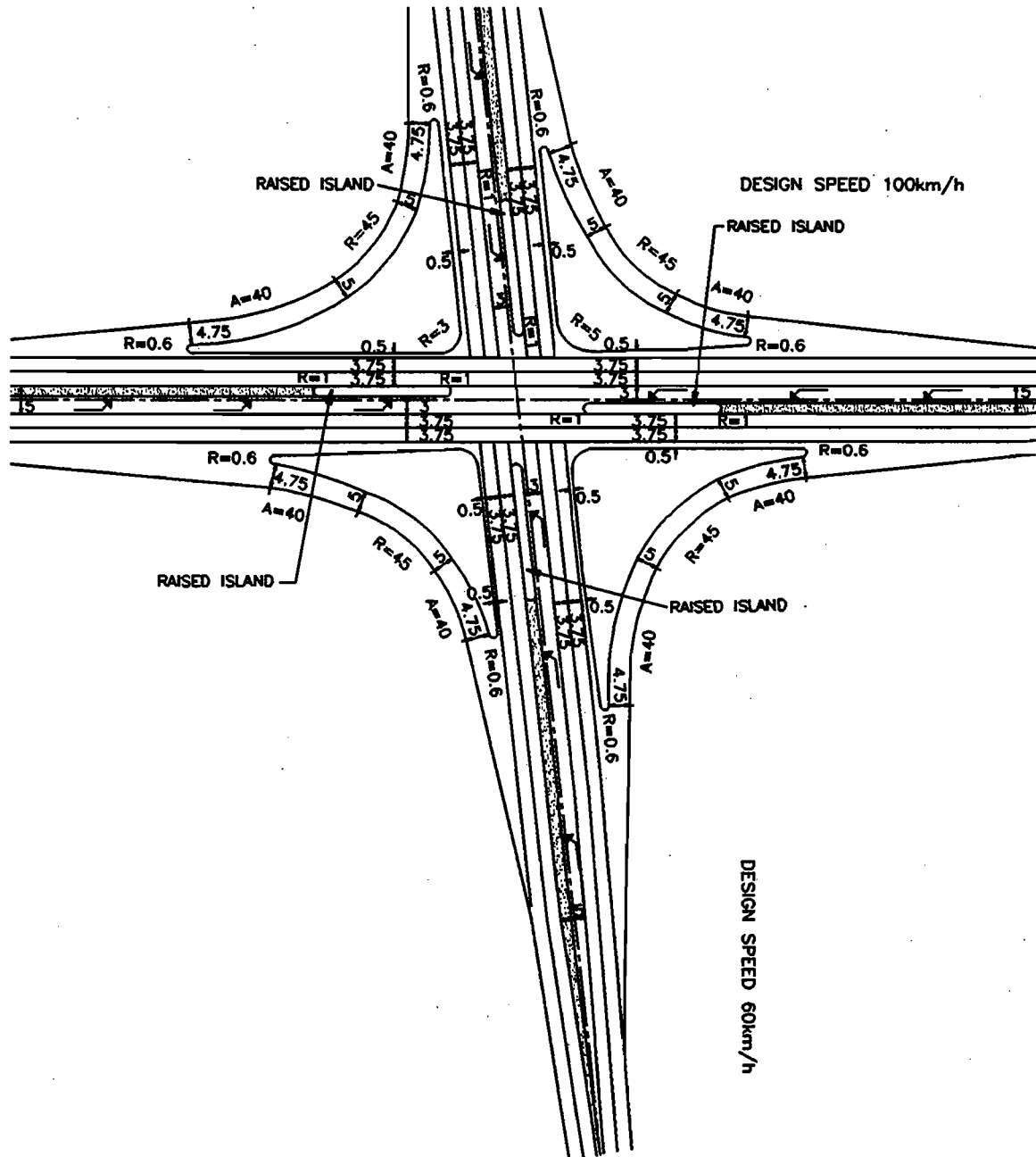

Figure E8-14

Fully Channelized Intersection

E.9 LEFT TURN LANES; UNSIGNALIZED INTERSECTIONS

POLICY

WHEN THE NUMBER OF LEFT TURNING VEHICLES AT INTERSECTIONS IS SUCH THAT IT CREATES A HAZARD AND REDUCES CAPACITY, CONSIDERATION SHOULD BE GIVEN TO THE PROVISION OF A SEPARATE LEFT TURN LANE DESIGN, CONSISTING OF A DECELERATION LANE AND A LEFT TURN STORAGE LANE.

The addition of a left turn lane will facilitate the through traffic flow on the by-pass lanes.

The deceleration lane is comprised of a parallel lane with taper and varies in length according to the design speed and the grade of the highway. The deceleration length is equal to the length of the parallel lane plus 2/3 of the length of the taper. See Figure E9-1. The application of the left turn lane taper results in a deflection of the through traffic lane. However, this can be minimized or softened by the use of flat curves at the beginning and end of tapers.

For deceleration lane lengths see Table E9-1.

The left turn storage lane requirements for two-lane, four-lane divided and undivided highways are based on:

- volume warrants; and
- accident warrants

Volume Warrants

When opposing traffic volumes are such that left turning vehicles must wait for a gap to make their turn, they interfere with the through traffic. The magnitude of this interference depends on:

- (1) the opposing volume, (2) the advancing volume and (3) the percentage of left turning vehicles.

Uniform volume warrants graphs and design guidelines of left turn storage lanes at unsignalized intersections have been developed and were based on theoretical analysis and on a series of field studies of traffic behaviour at intersections.

Accident Warrants

A left turn storage lane may also be considered at locations where four or more left turn related accidents occur per year or where six or more occur within a two year period, provided the accidents are of a type which could reasonably be expected to be eliminated by provision of a left turn lane. The storage length for the accident warrant is 15 m.

The warrant graphs, based on vehicles operating at the design speed indicated, show the conditions when left turn storage lanes should be added or where traffic signals are to be considered. For use of graphs see Appendices A, B and C.

When traffic signals are warranted, storage lengths are subject to the signal cycle timing and the graphs should not be used to determine the storage lane lengths.

Generally, the traffic volumes and directional flow diagrams are obtained from the Regional Traffic Section. The supplied information is then analyzed and checked for left turn lane requirements.

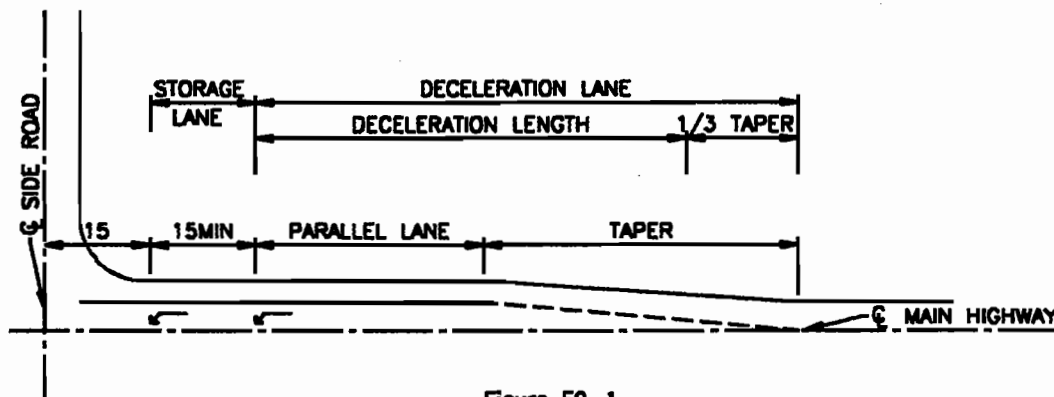

Figure E9-1

Left Turn Lane
Pictorial Description of Terms

For grades greater than 2%, the length of deceleration lane should be corrected according to the factors shown in Table E9-2. The correction is attained by multiplying the deceleration length added to 1/3 taper will comprise the total deceleration lane. The length of taper remains as shown in Table E9-1.

Painted line and indicated by painted arrows, as shown in the Manual of Uniform Traffic Control Devices.

The Runout Lane

The runout lane terminates the adjacent left turn lane on the far side of the intersection. The width of the parallel section of the runout lane is same as that of the left turn lane. The taper length varies with the design speed and is the same as that applied to the deceleration lane. The runout lane is indicated in Figures E9-2 and E9-3.

The width of left turn lanes should be one increment (0.25 m) less than the through lane with a minimum of 3.25 m and separated from through lanes by a solid

HWY DESIGN SPEED (km/h)	TAPER (m)	PARALLEL LANE (m)	DECELERATION	
			LANE (m)	LENGTH (m)
50	85	20	105	77
60	100	30	130	97
70	115	40	155	117
80	130	50	180	137
90	145	60	205	157
100	160	70	230	177
110	170	80	250	193
120	180	90	270	210

Table E9-1

**Deceleration Lengths for Left Turn Lanes;
For 2-Lane and 4-Lane Highways
Flat Grades 2% Less**

	DOWN GRADE %	GRADE FACTOR > 1	UP GRADE %	GRADE FACTOR ≤
ALL	8 - 7	1.5	2 - 3	1.0
DESIGN	7 - 6	1.4	3 - 4	0.9
SPEEDS	6 - 5	1.4	4 - 5	0.9
km/h	5 - 4	1.3	5 - 6	0.8
	4 - 3	1.2	6 - 7	0.8
	3 - 2	1.1	7 - 8	0.7

Table E9-2

**Grade Factors
for Deceleration Length**

An additional length should be added to the graph value if the percentage of the left turning trucks is significant.

Example: Storage lane length: 40 m
 Percentage of WB-15 trucks in left turning volume: 25%
 Additional storage lane length: 15 m
 Total storage lane length: 55 m

Table E9-3 lists additional storage lengths based on truck percentages of left turning volumes, V_L , and storage length, 'S', obtained from warrant graphs.

The minimum storage length that should be provided: 15 m.

"S" STORAGE LENGTHS FROM WARRANT GRAPHS; APPENDIX A,B, OR C	PERCENTAGE OF WB-15 TRUCKS IN LEFT TURNING VOLUME, V_L						
	10%	15%	20%	25%	30%	40%	50%
	ADDITIONAL STORAGE LANE LENGTHS IN METRES						
15	10	10	10	10	10	15	15
25	10	10	10	10	10	15	15
30	10	10	10	10	15	15	15
40	10	10	10	15	15	15	25
50	10	10	15	15	15	25	25
55	10	15	15	15	25	25	30
65	10	15	15	15	25	30	30
70	10	15	15	25	25	30	40
80	10	15	15	25	25	30	40
90	15	15	25	25	30	40	50
95	15	15	25	25	30	40	50
105	15	15	25	30	30	50	55
110	15	25	25	30	40	50	55
120	15	25	25	30	40	50	65
130	15	25	30	30	40	55	65

Table E9-3

Additional Storage Lane Length For WB-15 Trucks

E.9.1 LEFT TURN LANES FOR TWO-LANE HIGHWAYS

In the intersection design process the traffic volumes and flow diagrams are analyzed and adequate numbers and configuration of traffic lanes established. For left turn warrant graphs and application see Appendix A.

Left turn lanes are required when conflicts between through and turning traffic cause congestion or create collision hazards. Those requirements are generally substantiated by applying the left turn lane warrant graphs.

E.9.1.1 Left Turn Lane in One Direction

The left turn lane at 'T' intersections and on one approach to cross intersections is applied where the turning volume warrants a separate left turn lane.

The left turn lane can be developed:

- (a) on the right of the highway centre line
 - (b) on the left of the highway centre line
 - (c) in the middle of the highway cross-section.
- (a) The left turn lane design on the right of the highway centre line is the preferred type. The by-pass lane for the through traffic is added on the right or outside of the original through lane, see Figure E9-2 (a).

The lengths of by-pass lanes are governed by the lengths of the left turn lanes, which in turn vary with the volume of left turning traffic and the highway design speed. Appropriate roundings are applied throughout the by-pass lane to soften the deflection angles.

- (b) The left turn lane designed on the left side is applicable at intersections where the right of way restrictions do not permit the construction of an additional lane on the right of the highway alignment. A well defined pavement marking should be applied in the left turn runoff lane on the far side of the intersection to deflect opposing traffic around vehicles in the left turn lane, see Figure E9-2(b), especially in cases of curved alignment as shown in Figure E9-11.
- (c) The left turn lane designed in the middle of the roadway is acceptable where the full additional lane width on the right of the centre line cannot be accommodated. Although the through traffic is deflected by one-half of the lane width, a well defined pavement marking should be applied in the left turn runoff lane. See Figure E9-2(c).

The design illustrated in Figure E9-3 is applied only when the projected traffic flow will not indicate a need for a left turn lane in two directions.

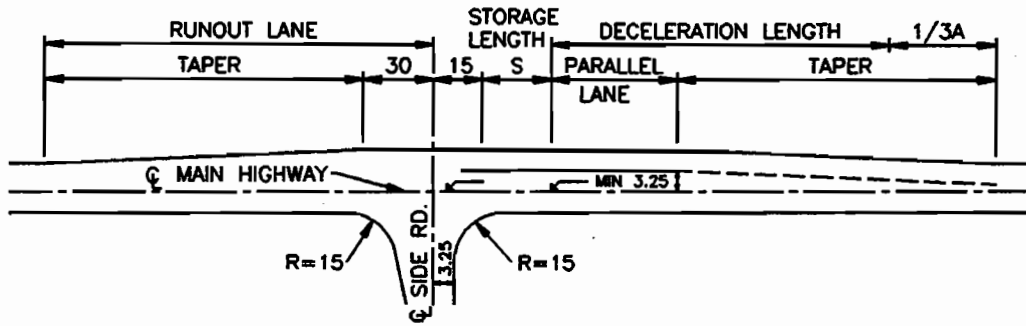

(a) Left Turn on right of centreline with by-pass lane

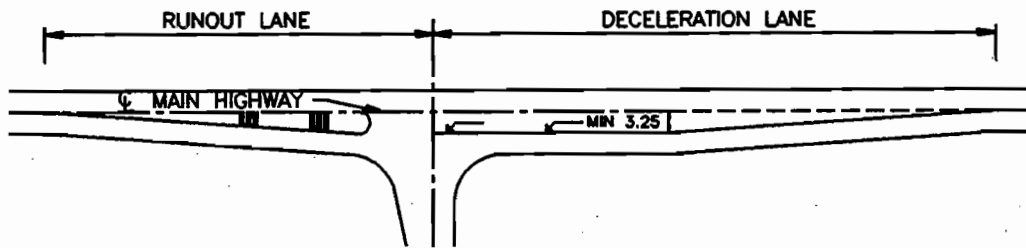

(b) Left turn on left side of centreline
in case where condition (a) and (c)
cannot be applied

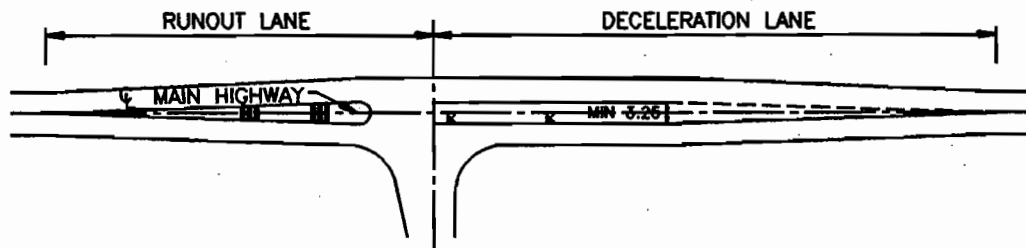

(c) Left turn in centre of centreline

Figure E9-2
Left Turn Lanes at 'T' Intersections

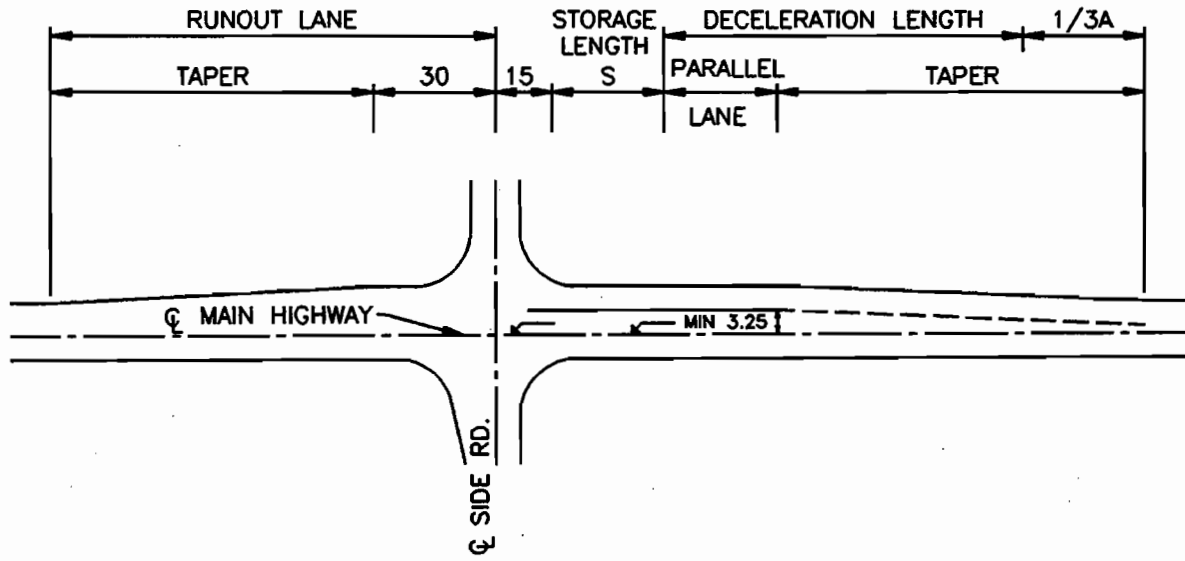

Figure E9-3

Left Turn Lane at Cross Intersection

E.9.1.2 Left Turn Slip Around Treatment at "T" Intersections

A left turn slip around is introduced on two-lane highway at "T" intersections under the following conditions:

- where the left turning volumes do not warrant a standard left turn lane but are sufficient to cause problems for through traffic;
- where by-passing vehicles throw gravel from the shoulder onto the highway.

The slip around design is comprised of a 45 m parallel lane and 50 m tapers at each end, as shown in Figure E9-4.

When the main highway is on a curved alignment, the length of the taper at each end of the slip around should be adjusted to minimize the deflections created by the tapers.

Usually the slip around design is not applied on four-lane undivided highway, however, where the left turn lane is not warranted and the turning vehicles significantly impede the through traffic, the slip around has its merit.

The left turn slip around treatment for four-lane highways is considered where the opposing traffic flow does not provide adequate gaps for turning vehicles.

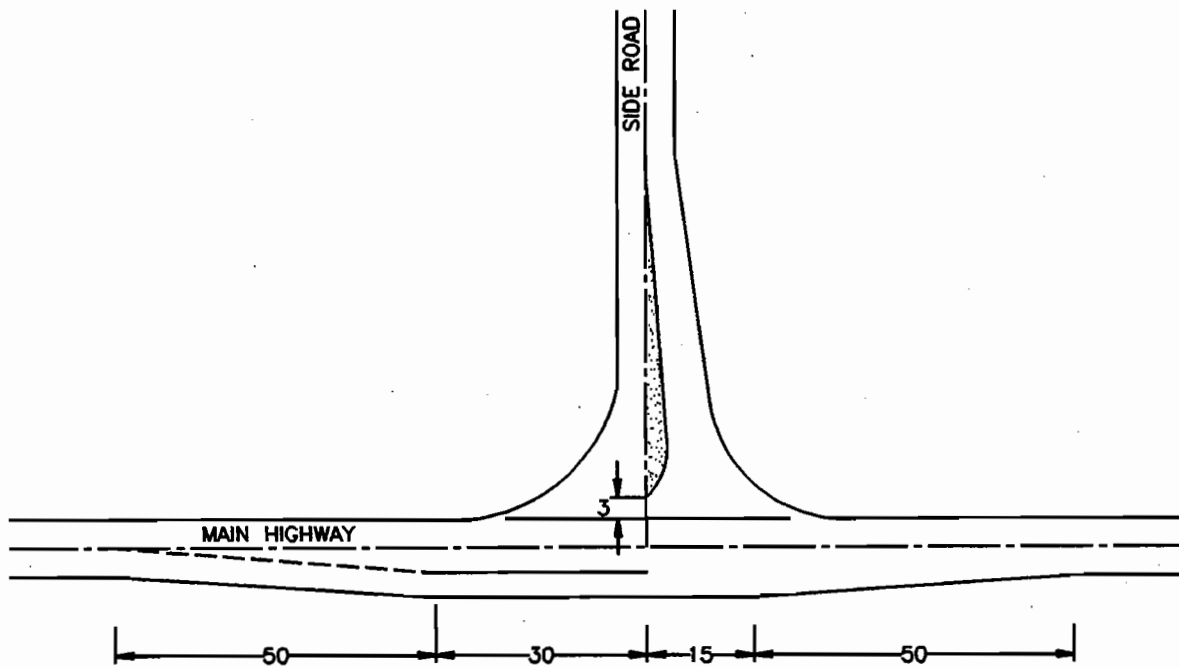

Figure E9-4

**Left Turn Slip Around Design
Tangent Alignment**

E.9.1.3 Left Turn Lanes in Two Directions

Left turn lanes for two-lane highways on both approaches to an unsignalized cross intersection are designed where the warrants determined from the warrant graphs indicate their need.

Two types of left turn lane designs are applicable:

- a) Opposing left turn lanes, see Figure E9-5(a) for the two-lane highway and Figure E9-8 for the four-lane undivided highway, and
- b) adjacent left turn lanes, see Figure E9-5 (b)

Opposing left turn lanes have the advantage of enabling drivers making simultaneous left turns to see past each other's vehicle and therefore, this design contributes to the ease and safety of left turn movements. The provision of adjacent left turn lanes is not generally recommended, because the potential

for accidents caused by visibility problems for left turning vehicles from the opposite direction as a result of the presence of vehicles in adjacent left turn lanes.

- a) Opposing left turn lanes

The opposing left turn lanes design is the recommended standard treatment for new construction of unsignalized intersections in rural areas. This treatment should be applied to all rural two-lane highways and can be used for urban areas at any intersection where left turn lanes are required.

- b) Adjacent left turn lanes

The adjacent left turn lanes can be designed where the intersection is located on or at the base of a steep down grade by providing the left turn lane run-out. The provision of a run-out lane provides a driver with the ability of avoiding conflicts in adverse weather conditions when the encroachment in the opposing left turn lane may be a safety concern.

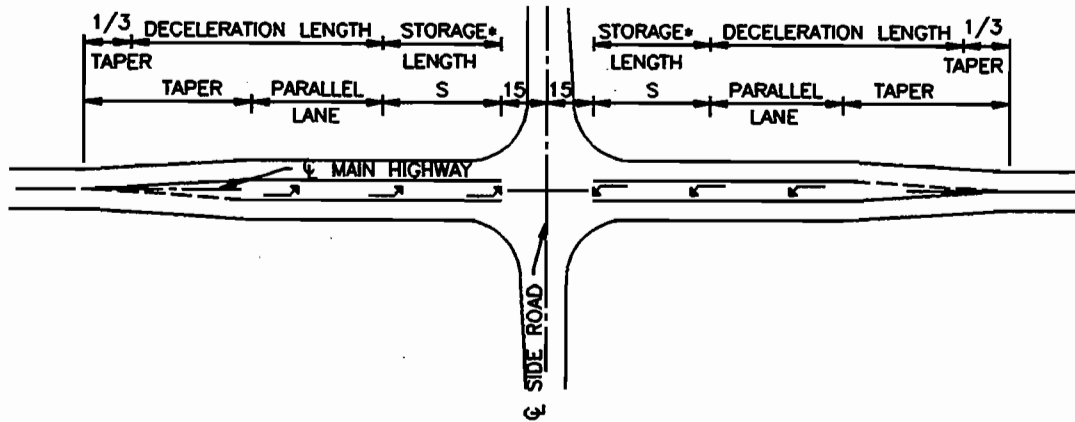

(a) Opposing left turn lanes

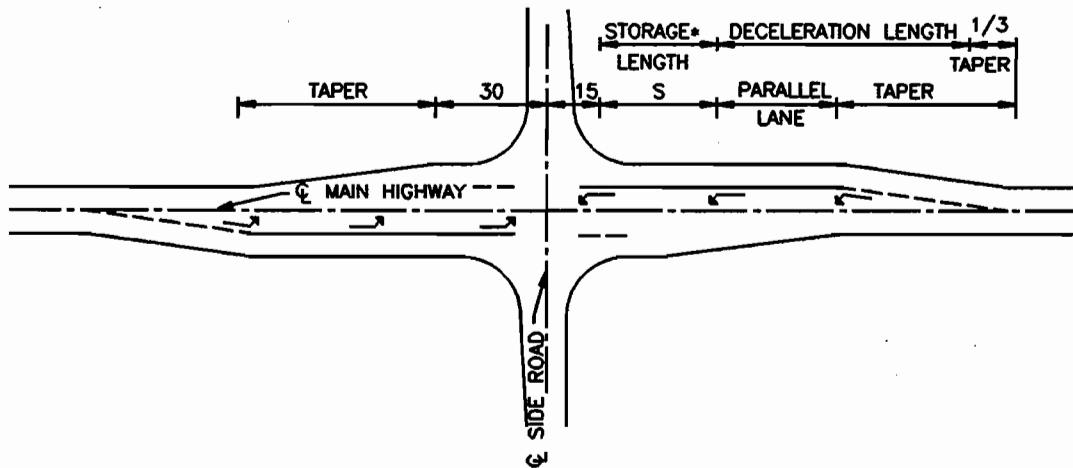

(b) Adjacent left turn lanes

- • The storage length 'S' varies according to the volume of left turn and opposing vehicles; see warrant graphs in Appendix A.
- The deceleration length consists of the parallel lane plus 2/3 of the taper, see Table E9-1.
- For truck percentages and additional storage lane length, see Table E9-3.

Figure E9-5

Left Turn Lane Design, 2-Lane Highway

E.9.2 LEFT TURN LANE DESIGN ON SIDE ROAD

It is undesirable to have a double entry from the side road to the highway with stop sign control except at certain low speed urban locations. The possibility of an adjacent standing vehicle blocking the vision of a

driver preparing to enter the highway may create an unsafe situation.

Signalization should be considered for intersections with two-lane entry on the side road. See Figure E9-6.

If signal warrants are not met, the intersection should be designed for one-lane entry only.

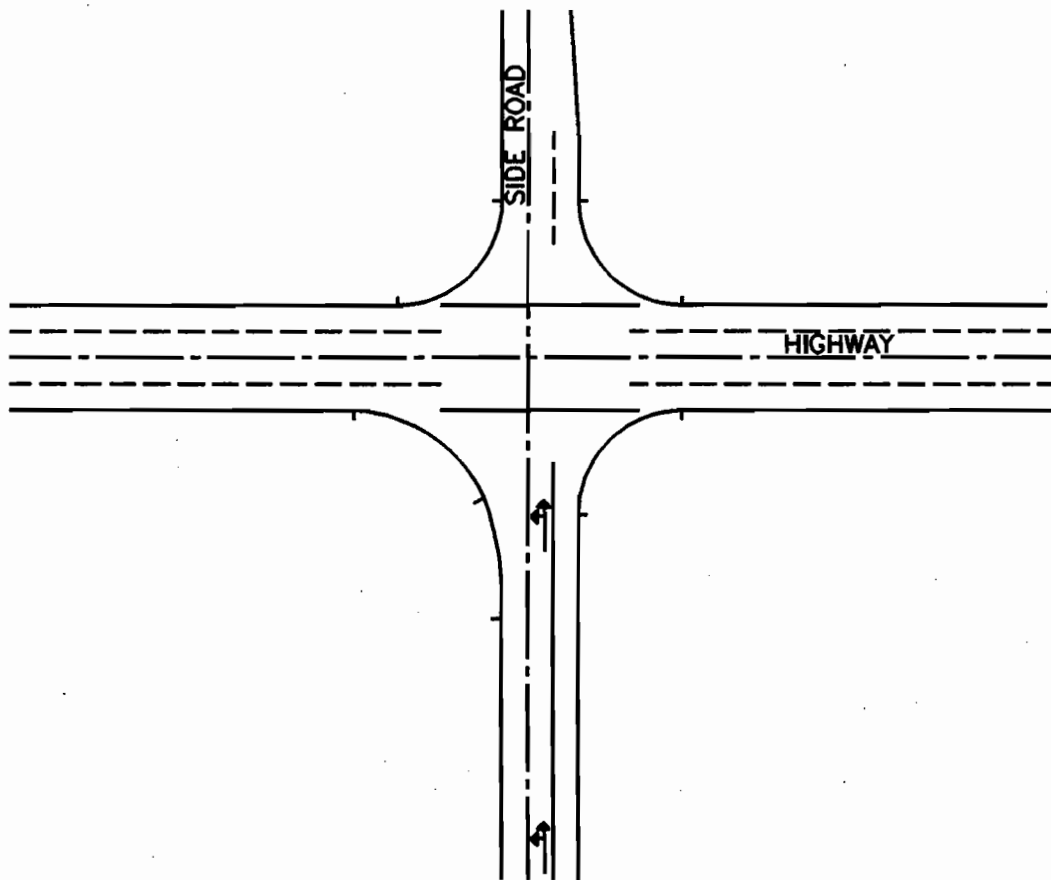

Figure E9-6

Left Turn Lane Design on Side Road

E.9.3 LEFT TURN LANES FOR FOUR-LANE UNDIVIDED HIGHWAY

The left turn lane design for four-lane undivided highways is illustrated in Figures E9-7 and E9-8. This design is applied at 'T' intersections, and also at Cross intersections, where the opposing left turn lane design is utilized, providing that the horizontal alignment within the left turn lane development is on tangent. The application of the opposing left turn lane design is described in Sub-Section E.9.1.3.

The deceleration lane length is the same as for the two-lane highways, see Table E9-1.

For storage lane length refer to the graph in Appendix B.

E.9.4 LEFT TURN LANES FOR FOUR-LANE DIVIDED HIGHWAYS

For detailed design of deceleration length see Section E.10.3.

For storage lane length see the graph in Appendix C.

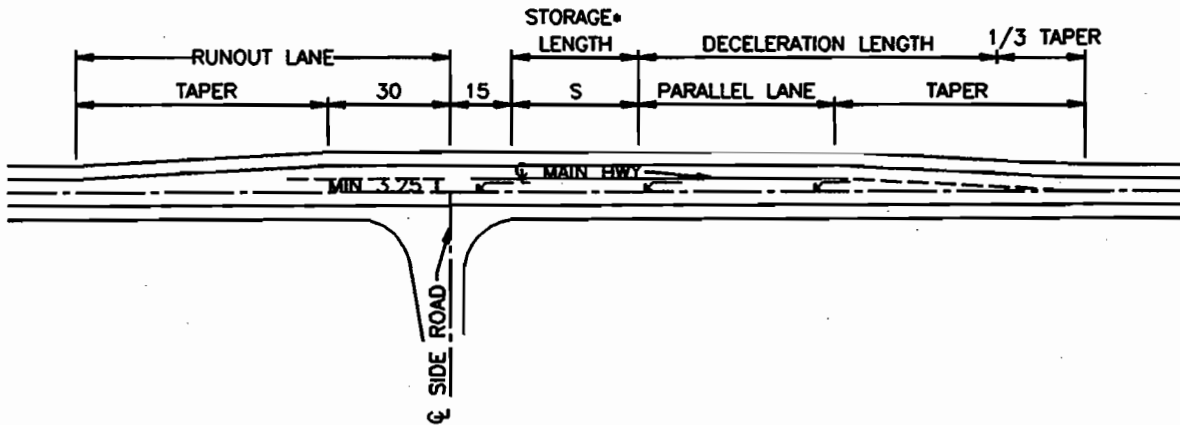

Figure E9-7

Left Turn Lane Design, 4-Lane Undivided Highway
'T' Intersection

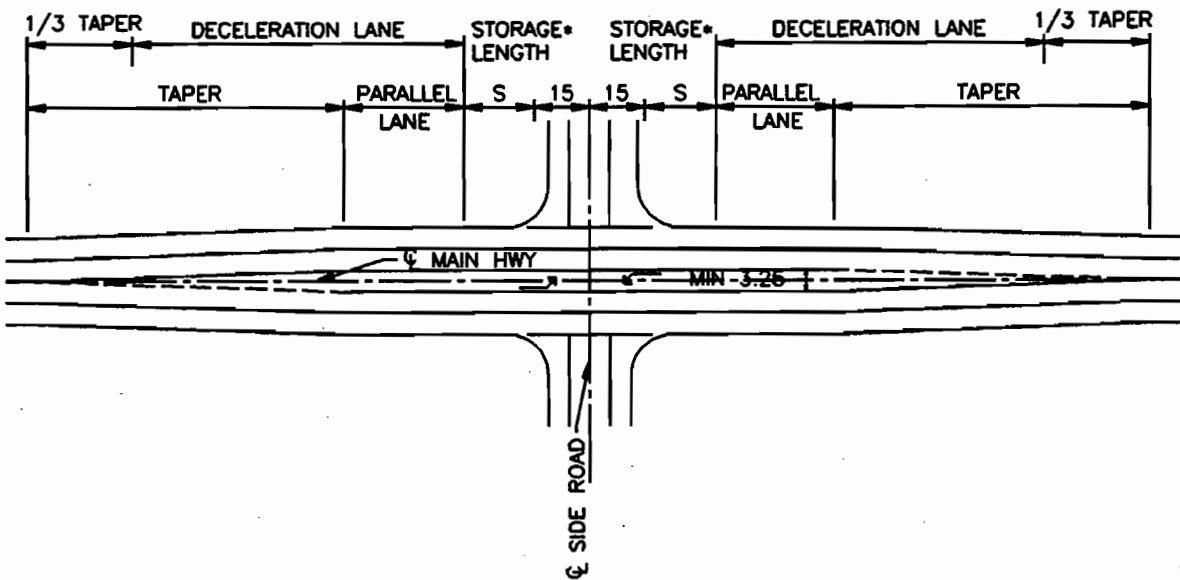

Figure E9-8

Opposing Left Turn Lane Design, 4-Lane Undivided Highway
Cross Intersection

- * The storage length "S" varies according to the volume of left turning and opposing vehicles; see warrant graph in Appendix B.
- The deceleration length consists of the parallel lane plus 2/3 of the taper, see Table E9-1.
- For truck percentages and additional storage lane length, see Table E9-3.

E.9.5 LEFT TURN LANE DESIGN ON CURVED ALIGNMENT

Tangent alignment through the intersection including the full length of the left turn lane, is preferable to a curved alignment. However, curved alignment is often unavoidable at intersections and therefore certain design procedures for left turn lanes must be considered.

On new alignments, flatter than minimum curvatures should be used on centre line so that sub-standard curves do not result if and when left turn lanes are introduced in the future.

When applying left turn lanes on curved alignment, the additional pavement widening required is added to the inside of the curve whenever it is practical to do so. See Figure E9-9.

Of particular importance is the appropriate pavement width throughout the deceleration length. The width should not be less than that available for left turn lanes on tangent highway alignment.

For highway alignment curving to the left on intersection approaches, part of the widening on the inside of a curve may be attained by using a splined construction centre line as shown in Figure E9-10.

On curved alignments the taper deflection angles can be reduced by applying flat and/or splined curves. For typical examples see Figures E9-9, 10, 11 and 12.

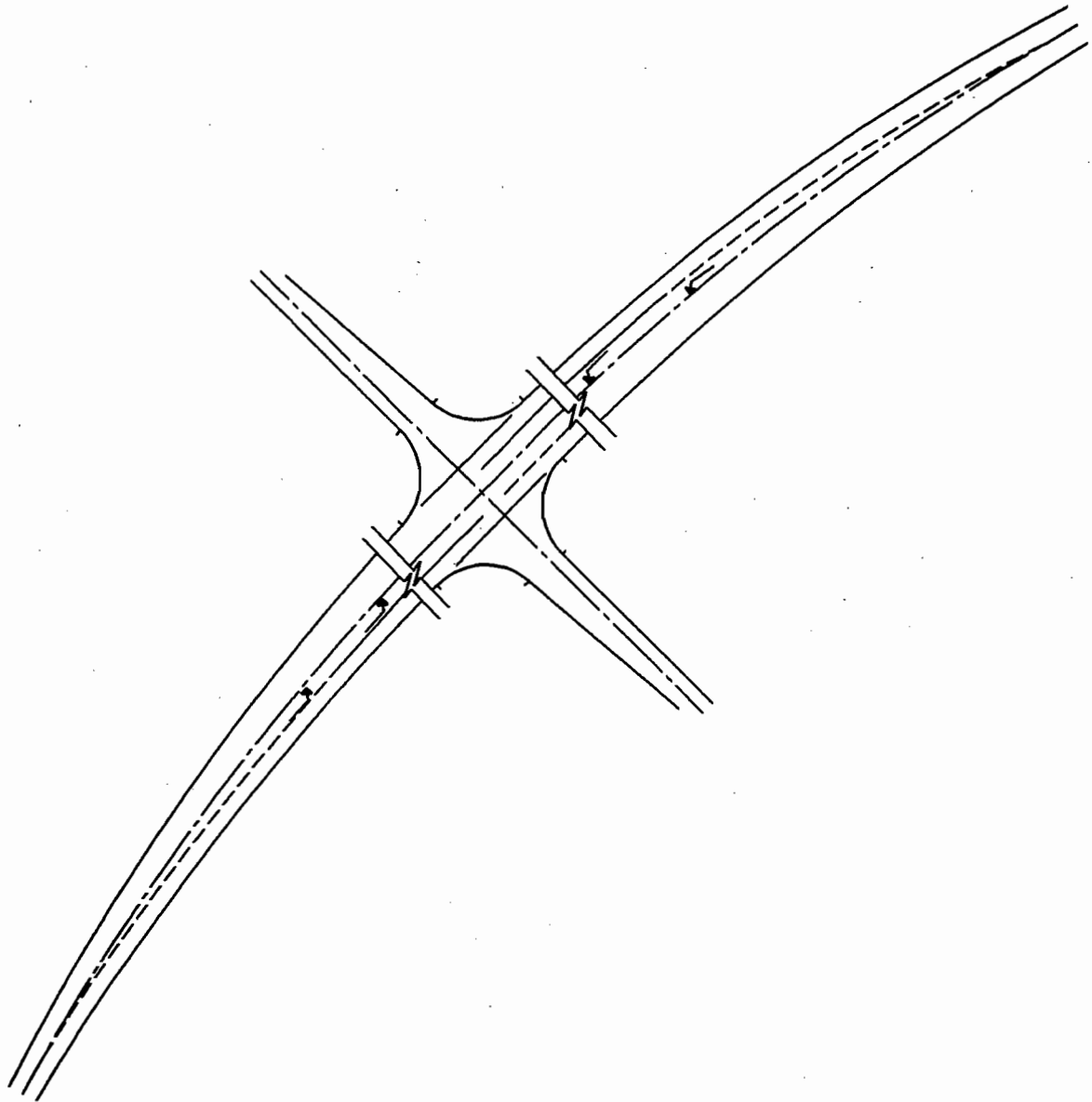

Figure E9-9

Left Turn Lane Design
Alignment Improvement to Eliminate Deflections

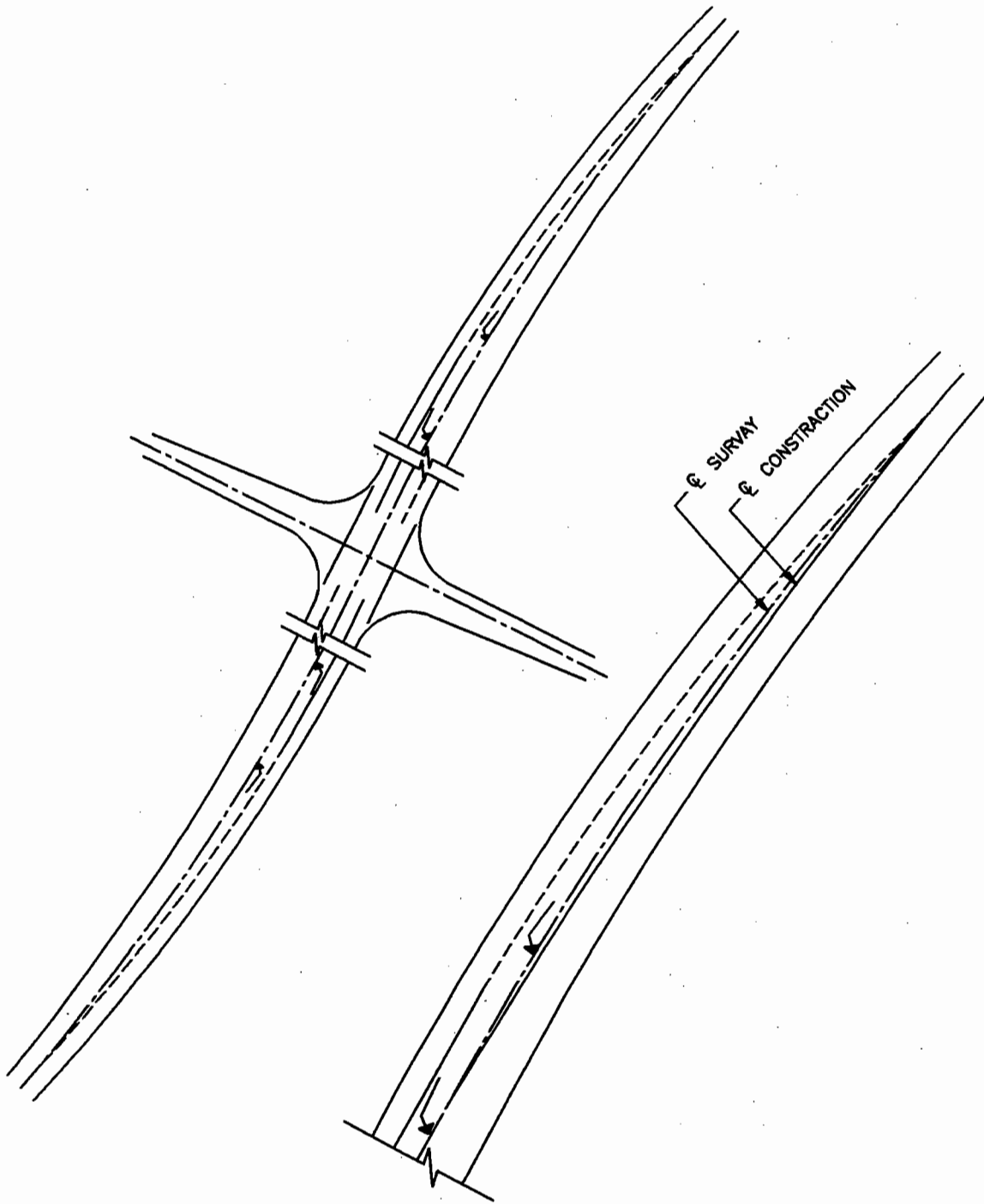

Figure E9-10

Left Turn Lane Design
Alignment Improvement to Eliminate Deflections

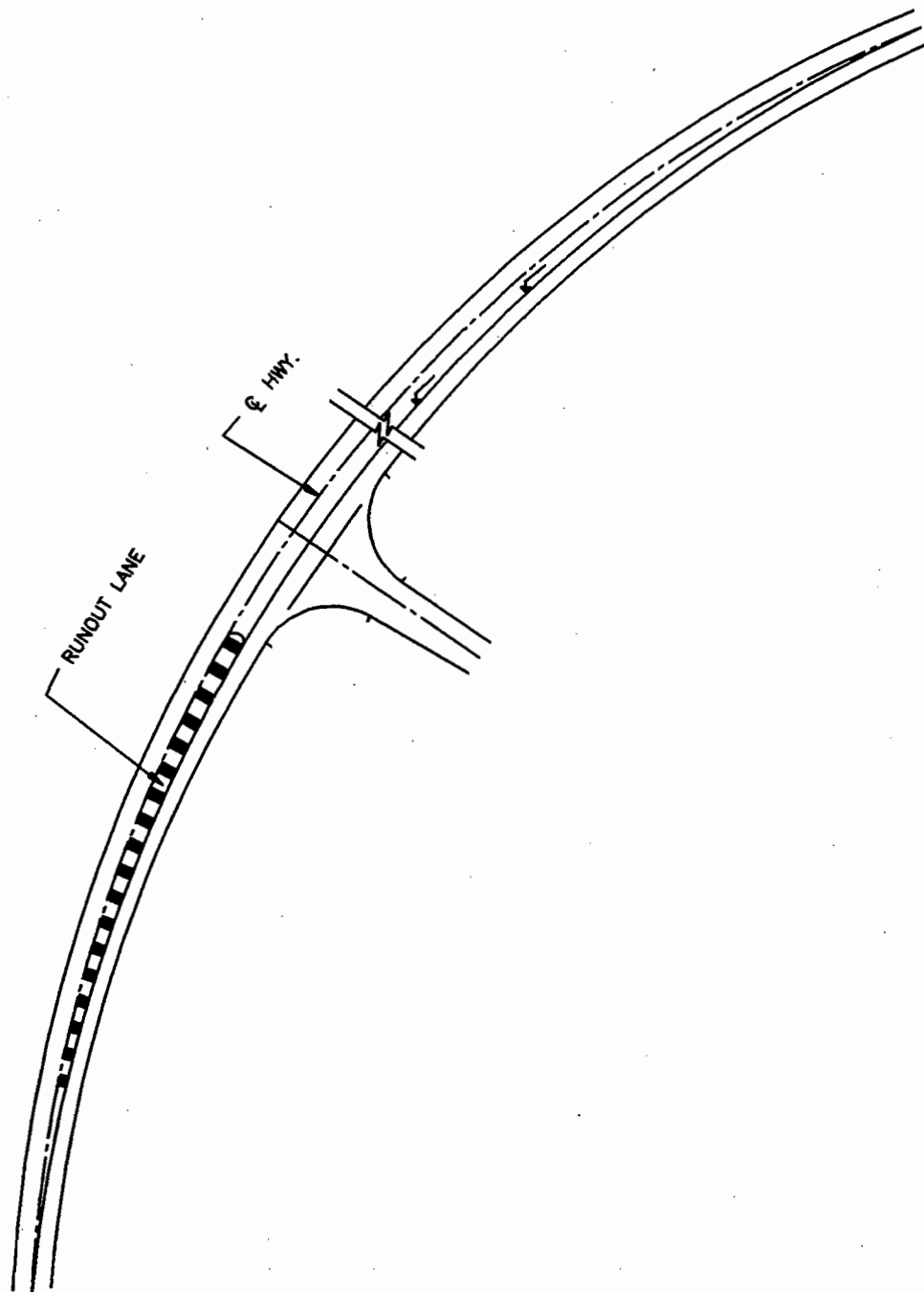

Figure E9-11

Left Turn Lane Design
Alignment Improvement to Eliminate Deflections

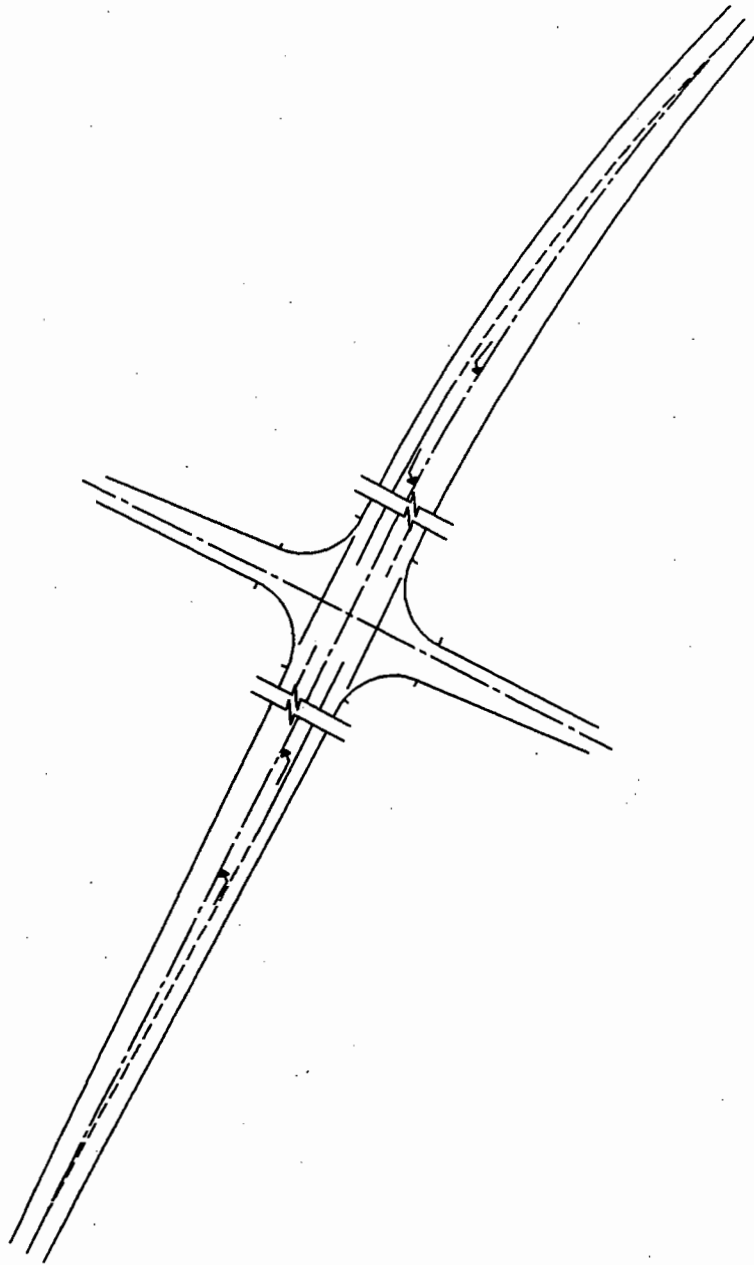

Figure E9-12

Left Turn Lane Design
Alignment Improvement to Eliminate Deflections

E.10 LEFT TURN LANES; SIGNALIZED INTERSECTIONS

Most of the intersection designs described and illustrated in the preceding subchapters are adaptable to either signing control, or a combination of both.

An intersection consisting of through lanes and separate left turn lanes may require a signal control when the volume of traffic entering the intersection is such that the traffic flow allows insufficient gaps to permit all intersecting vehicles to enter, turn or cross the intersection with little delay or inconvenience. The decision to install a traffic signal must be based on a careful evaluation of the volume warrants and approved traffic guidelines. The overall traffic operation is the responsibility of the Regional Traffic Section. The service volumes that a signalized intersection can accommodate and the capacity are dependent on the traffic factors, intersection geometrics and signal operation.

As a general guideline, left turn lanes must be considered on all highway approaches and also on high speed sideroad approaches at all signalized intersections whether the left turn warrants are met or not, unless the left turn is prohibited by geometrics (T-intersection) or traffic regulations (one-way traffic).

Separate left turn lanes at signalized intersections have the advantages of increased safety, improved intersection capacity, flexibility for possible signal phasing schemes and clarity of purpose.

For left turn lane standard dimensions, refer to Subchapter E.9. The length of a left turn storage lane depends on the intersection being signalized or unsignalized. For signalized intersections the left turn storage lane length is a function of the signal cycle length and left turn traffic volume, whereas the left turn storage lane length for the unsignalized intersection is determined from the warrant graphs in Appendix A. If the graphs indicate "traffic signals may be warranted" then the designer should contact the Regional Traffic Section for clarification.

A left turn storage lane can function with or without separate left turn traffic signal phasing. The Regional Traffic Section shall provide the left turn storage lane length for the recommended signal operation and timing, as well as the possible left turn phasing, the placement of signal poles and type of signal heads.

It is essential that intersection design is accomplished simultaneously with the development of traffic control plans to ensure that sufficient space is provided proper installation of traffic control devices. Directional as well as divisional (raised median) islands provide locations for traffic control devices such as signals or directional signs. However, traffic islands constructed solely for this purpose should be carefully designed in order that they do not become a built-in hazard. For directional and divisional islands see Sections E.8.14 and E.10.1 respectively.

At signalized intersections the geometrical configuration of the entire intersection design should be coordinated with the appropriate signal design and traffic signal phasing consistent with the operational requirements of both present and future traffic demands. The Planning and Design Section, therefore, should have early liaison with the Regional Traffic Section.

The alignment and profile of the highway approach to a signalized intersection should permit the driver an adequate, continuous view of the signal heads, see Table E3-4.

E.10.1 DIVISIONAL ISLANDS

Divisional islands, also referred to as raised median islands, usually barrier-curbed, are generally used to:

- separate opposing traffic flows,
- alert the driver of the cross-road ahead,
- regulate the left turning and through traffic movements.
- guide traffic around obstacles,
- locate traffic control devices where they are easily visible, and
- aid and protect pedestrians at or near a crosswalk by providing a refuge between opposing traffic streams.

At signalized intersections having cross-sections of five lanes or more including left turn lanes, divisional islands shall be used. Opposing approaches should be carefully designed for geometric continuity by providing the same cross section on both sides of the intersection.

Divisional islands may be considered at signalized intersections with four lane cross-sections depending on the signalization requirements. The Regional Traffic Section should be consulted for a recommendation in this situation.

Divisional islands should not be used at signalized intersections where the geometrics will result in only a single lane between the divisional island and the edge of the road or another island. If such a case arises because the islands are required for locating signal poles due to left turn phasing requirements, consideration should be given to adding an auxiliary lane through the intersection, see E.10.2.3.

The divisional islands are a minimum of 2 m wide, including curb and gutter, and are usually 30 m long (15 m minimum). The islands, when used in conjunction with a 3 m wide left turn storage lane from each direction, are offset, providing an overall minimum pavement width of 5 m between opposing through lanes.

Opposing divisional islands are designed at 'T' intersections where the left turn lane is to be provided in one direction only from the major road, or, at 'cross' intersections where the left turn is prohibited in one direction by traffic regulations (one-way traffic). This layout provides for a permissive or an advanced green left turn operation. See Figure E10-1.

The offset divisional island design is used where left turn lanes are required at 'cross' intersections. The islands are offset by 0.5 m from the centre line, see Figure E10-2. The offset divisional islands often are introduced at 'T' intersections having five lanes or more where future conversion to a 'cross' intersection is expected, or, to facilitate a fully-protected left turn phasing traffic operation. Proper evaluation by the Regional Traffic Section of the anticipated type of traffic operation will assure an applicable design for both present and future traffic demands.

The location or setback of the raised islands from the centre of the intersection is determined by applying appropriate design vehicle turning templates. For 90° or near 90° intersections the distance of 15 m accommodates the WB-15 design vehicle turns. However, it is necessary to check the local traffic composition and future conditions for the suitable design vehicle application, in which case the island setback distance will be determined; see Figure E10-1 and E10-2. The location of the pedestrian crosswalk markings should be applied as indicated in the 'Manual of Uniform Traffic Control Devices', Figure C21-A, where the raised islands should not extend into the pedestrian area.

Curbed islands are sometimes difficult to perceive at night and may become road hazards. This condition can be alleviated by providing the intersection with partial illumination.

Note:

- On the following diagrams the 2 or 4-lane side road cross sections are for illustration purposes only and do not represent actual lane requirements.
- The island setback is determined by applying the appropriate design vehicle turning template.

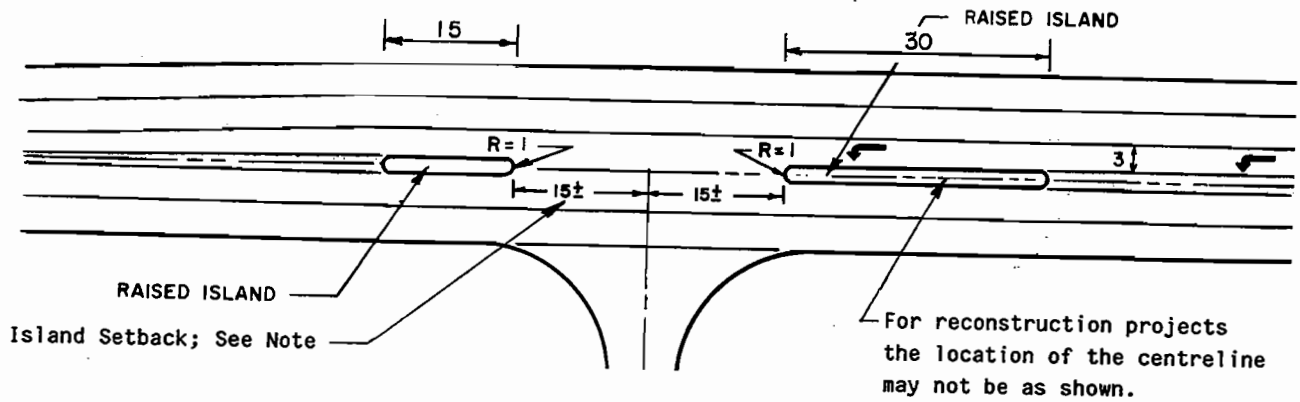

Figure E10-1

Opposing Divisional Islands

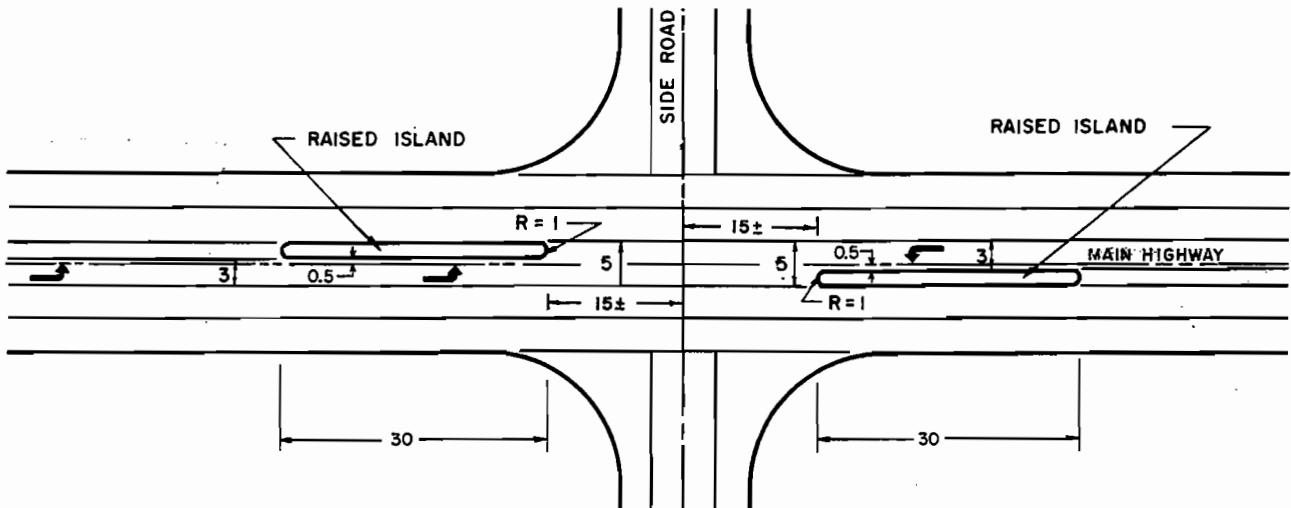

Figure E10-2

Offset Divisional Islands

E.10.2 LEFT TURN LANES FOR FOUR-LANE UNDIVIDED HIGHWAYS

There are two distinctly different left turn lane designs:

- a) with divisional raised islands; opposing or offset and
- b) without islands; opposing or adjacent lanes.

The selection of the appropriate design depends on the number of lanes and the geometrical configuration of the intersection; it is also dependent on specific conditions.

Signalized intersections having a cross section of five lanes or more, including left turn lanes, must have the signal poles placed in the median and protected by raised, barrier-curbed islands.

The opposing left turn lane design having a cross-section of five lanes or more, including left turn lanes may be applied in rural areas where an intersection is signalized or will be signalized at the time of construction. For detail of this design refer to sub-section E.9.1.3.

At signalized intersections a mutual adjustment in profiles and cross-sections is required. In this case a 0.5% cross-fall is desirable. It reduces the algebraic difference of cross-over and improves the rideability in the intersection area. The profile control is placed at the median island curb nearest to the centre line. The crown line elevations are obtained by plotting control points along the median islands and splined for a smooth transition.

The left turn lane is comprised of a deceleration lane including a taper and a storage lane. For deceleration length, see Table E9-1. For application of grade factors in the design of the deceleration lane, see Table E9-2.

The storage lane length depends on the signal phasing, and the appropriate design values are to be obtained from Regional Traffic Section.

E.10.2.1 Left Turn Lane in One Direction

The design and application of a left turn lane at signalized intersections having a cross-section of five lanes or more depend on

- a) intersection type, and
- b) traffic volumes.

Raised median islands are generally used to provide locations for traffic control devices and to separate opposing traffic flows.

At 'T' intersections or at one-way traffic intersection the raised median islands are placed on the centreline and do not require offsetting. This design is also referred to as the left turn lane with opposing divisional islands, see Figure E10-3.

As a guide, a space required for two to three vehicles waiting for a left turn in the storage lane is a sufficient length indicator for the raised island, therefore, the minimum length is 15 m.

At the left turn run-out lane on the far side of the intersection, the raised island should be only 15 m for economic reasons. The length of the raised island adjacent to the left turn lane is dependent on the number of left turning vehicles and is usually 30 m long. A longer raised island may be considered, particularly in urban areas to deter left turns into private or commercial entrances.

If the existing 'T' intersection with opposing islands is to be redesigned to a 'cross' intersection where a left turn lane is warranted in one direction only, a standard left turn lane comprised of a minimum storage lane and deceleration lane (Fig. E9-1) is provided instead of the standard run-out lane. See note in Figure E10-4(i). In this case, the 15 m raised island requires offsetting from the centre line and this will, in effect, produce a design similar to the left turn lane design in two directions.

E.10.2.2 Left Turn Lanes in Two Directions

The design of left turn lanes in two directions is attained by offsetting the divisional islands from centre line, see Figure E10-4(ii).

The location of the raised median islands at skewed angle intersections should be ascertained by using the appropriate design vehicle turning template and from the location of pedestrian crosswalks.

A minimum 15 m island could be used to permit access to an adjacent commercial establishment or a longer than 30 m island may be designed to prevent access to the site.

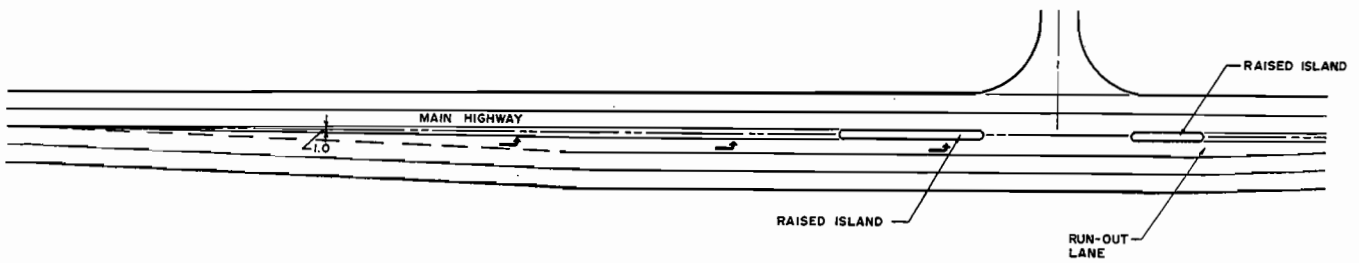
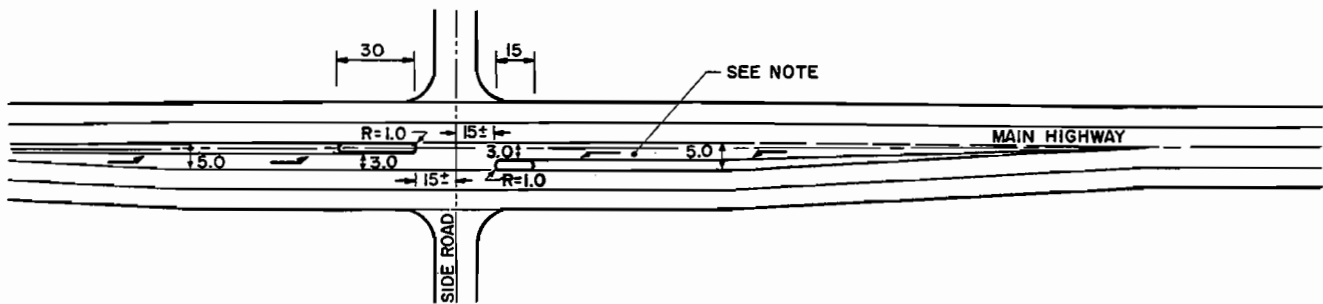

Figure E10-3
Opposing Divisional Islands at 'T' Intersections



- (i) **Left Turn Lane Warranted in One Direction; Run-Out Lane Replaced by Minimum Standard**

Note:

Minimum Left turn lane length used where the left turning volume does not warrant a left turn lane.

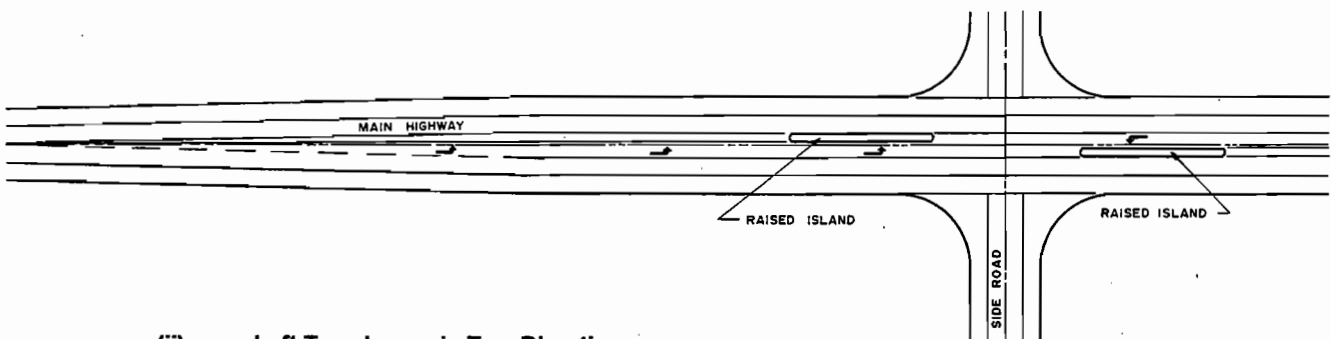

- (ii) **Left Turn Lanes in Two Directions**

Figure E10-4
Offset Divisional Islands at 'Cross' Intersections

E.10.2.3 Widening Through a Signalized Intersection

At a signalized intersection where the advancing volumes are such that vehicles will be delayed for more than one cycle length, the capacity through the intersection can be increased by providing an auxiliary lane in advance of the intersection and carried through and beyond the intersection for a considerable distance before being

terminated. This auxiliary lane permits a greater number of through vehicles to negotiate the intersection during each cycle. The extended length of lane beyond the intersection permits vehicles to adjust their acceleration speeds and positions to effect a smooth merge manoeuvre back to the basic traffic lanes. Figure E10-5 shows a nomograph, sketch and tables indicating the required lanes and taper lengths for various speeds.

- W_A - approach width in number of lanes including widening.
- Taper - deceleration and acceleration lane change lengths derived from design values calculated at 3.0 s (seconds) and 3.5 s (seconds) respectively for the appropriate operating speed.
- D_a - length of auxiliary lane to the stop block determined either from the nomograph by using the appropriate traffic factors to clear the through traffic or from the table below to permit the right turning vehicle to decelerate; the larger of the two values is selected.
- D_b - length of auxiliary lane from the stop block determined either by the formula $D_b = 3.5 G$ to clear the through traffic or from the table below to permit the right turning vehicle from the crossing road to accelerate; the larger of the two values is selected.

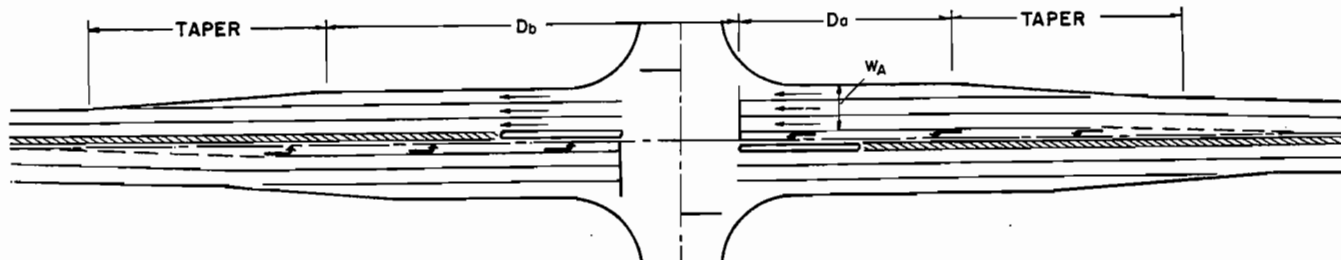
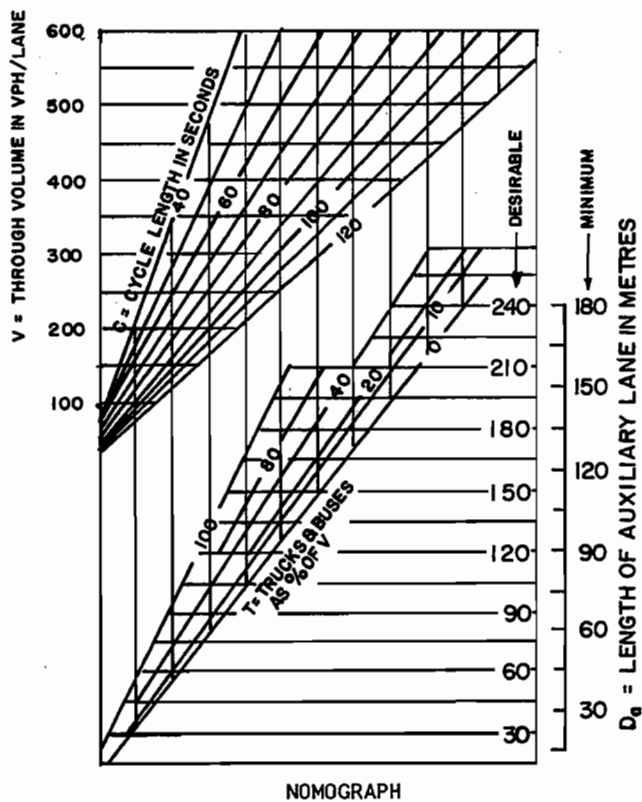

Length of Widening Beyond Intersections (Acceleration + Taper)			
Design Speed Km/h	Acceleration		Taper
	D_b m	$D_b = 3.5 \times G$	3.5 s m
50	-	G = Green Intervals in secs	50
60	15		60
70	55		70
80	90		80
90	155		85
100	220		95

Length of Widening In Advance of Intersections (Deceleration + Taper)			
Design Speed km/h	Deceleration		Taper
	D_a m	D_a - Nomograph	3.0 s m
50	20	Divide approach volume by no. of lanes in W_A , use volume per lane in chart, find ' D_a ' on desirable scale.	40
60	30		50
70	45		60
80	60		70
90	70		75
100	85		80

Figure E10-5
Widening Through A Signalized Intersection

E.10.2.4 Double Left Turn Lanes

Double left turn lanes are employed to accommodate heavy left turn volumes at signalized intersections and also at other locations, such as driveways to major traffic generators.

Where there is a capacity situation consisting of vehicles backed up in the left turn lane for some cycles, the provision of double left turn lanes will reduce the amount of green time for left turns, thereby reducing cycle lengths and providing added capacity for the other movements.

Two left turn lanes at signalized intersection will operate so that each lane handles very close to an equal volume of traffic during peak hours. The capacity of each left turn lane may be somewhat lower than of a single left turning lane, however, it is reasonable to expect at least a 75% increase in capacity by adding a second left turn lane.

The use and effectiveness of double left turn movement demand special attention to signing, signal phasing and storage lane needs. When multiple left turns are warranted at signalized intersections, a separate signal phasing should be used to allow the turning movements

without interference from opposing or cross traffic. Observations indicate that even minimal opposing movement will cause confusion and reduce the efficiency of the turning movement. For double left turn warrants and storage lane lengths refer to the Regional Traffic Section.

The configurations and commonly used double left turn lane designs are:

1. Exclusive double left turn lanes where both lanes are developed separately and in addition to the through traffic lanes, see Figure E10-6.

This design requires particular attention to available storage length to avoid double left-turn lane overflow and resulting blockage of through movements. This configuration, however, simplifies phasing at signalized intersections by not requiring the special phasing necessary under the optional layout shown in Figure E10-8.

The lane use control signing and pavement marking is also simplified with this layout, as entry to the double left turn lane requires a deliberate move to the left.

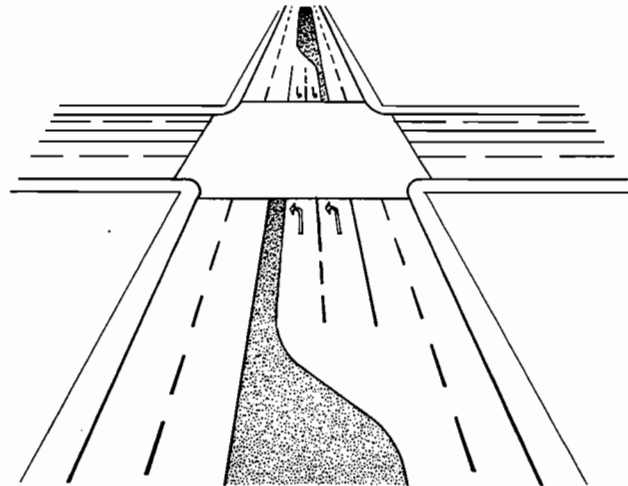

Figure E10-6

Exclusive Double Left Turn Lanes; Both Lanes Protected

- 2. Double left turn lanes where one of the mandatory turning lanes is not preceded by pavement markings.

While this design permits the same simplified signal phasing as described in case 1, attention must be given to lane use control signing and markings to divert through traffic from the mandatory left turn lane. Even the occasional violator could adversely affect the operational efficiency of this intersection type, see Figure E10-7.

- 3. Optional double left turn lane where the second lane is available for either left turns or through traffic.

The design provides greater flexibility in accommodating traffic demands by allowing for the dual use of traffic lanes. It is advantageous where roadway width limitations preclude the use of two exclusive turning lanes. The lane configuration reduces need for lane changing close to the intersection and the design can be applied where the storage lane length for left turn traffic is limited, see Figure E10-8.

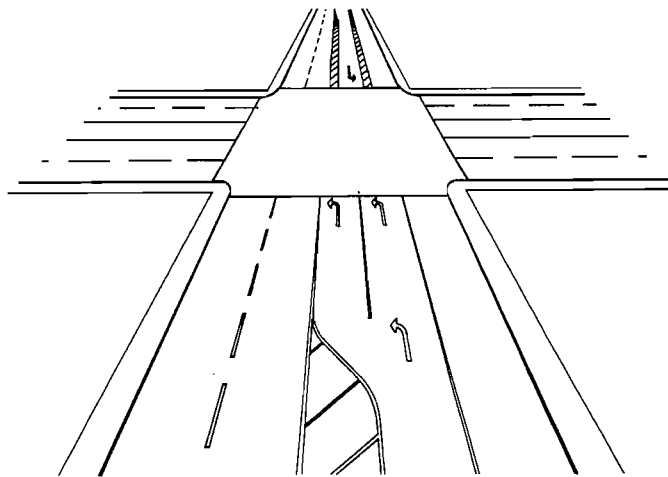

Figure E10-7

Double Left Turn Lanes; One Lane Protected

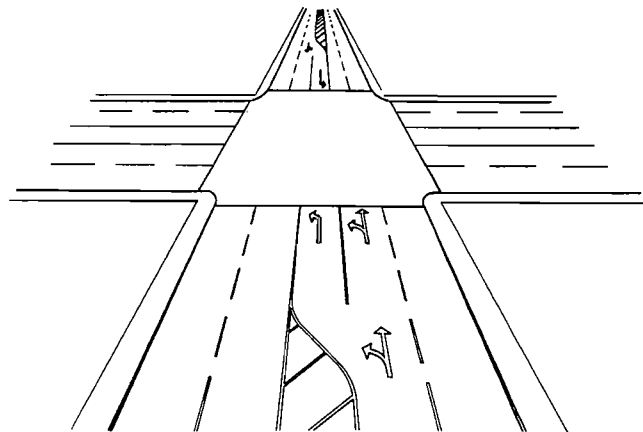

Figure E10-8

Double Left Turn Lanes; One Lane Optional

The left turn movement must operate simultaneously with the associated through movement, but not with the opposing through movement, to avoid blockage of the optional lane and the resulting rear-end collision potential.

The optional double left turn lane arrangement requires conspicuous signing and markings to identify the movements permitted in the optional lane and to provide its efficient and safe utilization.

In deciding upon which type of double left turn to design careful attention must be given to roadway geometrics, traffic composition (passenger cars, commercial vehicles) and traffic flow characteristics.

If the double left turn is to operate simultaneously with an opposing left turn movement, there must be sufficient width within the intersection to avoid a conflict in turning paths, see Figure E10-9. Turning radii and turning paths for all movements must be checked to ensure their adequacy.

The overall capacity evaluated to ascertain that the signal timing and phasing requirements of the double left turn design being considered are compatible. The capacity and efficiency of double left turn movements may be affected by the width of the roadway accepting the double turn, the angle of the turn and the adequacy of signs and markings.

The double left turn lane may be considered warranted when peak hour left turn approach volumes exceed 300 vehicles.

The decision for the approval of a double left turn lane design should be based upon criteria involving intersection capacity, intersection geometrics including available left turn storage lengths, the possibility of reducing overall delays at signalized intersections and observations indicating that traffic operations would be enhanced.

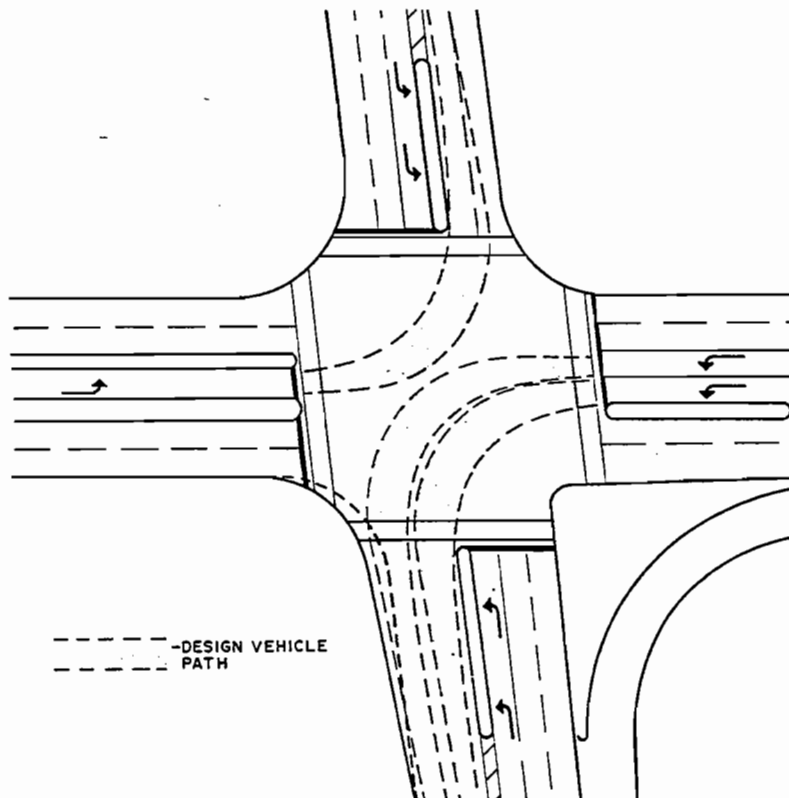

Figure E10-9

Turning Paths for Double Left Turns

E.10.3 MEDIAN OPENING DESIGN AND LEFT TURN LANES FOR DIVIDED HIGHWAYS; SIGNALIZED AND UNSIGNALIZED INTERSECTIONS

The outline and size of median openings at signalized or unsignalized intersections depends on the median width and is determined by the turning requirements of the WB-17.5 design vehicle. Median end designs generally in use are:

1. Semi-circle (simple bullnose)
2. Bullet-nose
3. Flat-nose

1. The semi-circular median opening design is used for narrow medians up to 5 m in width.

2. The bullet-nose shape median end design is required for medians ranging from 5 to 15 m in width. The size of opening and the shape of the bullet-nose is designed by the use of a WB-17.5 design vehicle turning template. The bullet-nose radii of the median opening guides the turning truck into the desirable path and lane. This design permits simultaneous left turn movements for trucks from each direction on the highway as well as turns from the side road and it allows a minimum width of median opening between bullnoses. See Figure E10-10.

3. The flat-nose median opening design is developed for wide medians of 25 m or more with the ends flattened in shape, parallel to the intersecting road centre line. This design affords a higher degree of operational advantage over the narrow bullet-nose median openings,

permitting the WB-17.5 design vehicle to pause off the through pavement while waiting for an opening and to pass each other when turning. Vehicles crossing the highway relate better to the flat-nosed opening and to the through lanes of the highway and drivers stopped in the median opening have a greater sense of security with regard to the front and rear of their vehicles. See Figure E10-11.

Figure E10-10 and -11 show the median opening requirements with a two-lane side road. Similar design principles, based on the turning requirements of the WB-17.5 design vehicle, are to be followed for the median opening design with a four-lane side road.

The design of the separate left turn lane for divided highways at median openings consists of the following:

- a storage lane 'S' with variable length beginning approximately 5 m from the bullnose. See Graph in Appendix 'C' for storage lane length,
- a parallel lane,
- a taper.

For lengths of parallel lane and taper see Table E10-1. The length of the deceleration lane is based on comfortable braking requirement. For design purposes it is assumed that:

- drivers entering the deceleration lanes travel at average running speed,
- half of the taper is suitable for deceleration and is to be included in the required length.

For signalized intersections the storage lane 'S' is to be obtained from the Regional Traffic Section.

Design Speed km/h	50	60	70	80	90	100	110	120
Taper (m)	40	50	60	70	75	80	85	90
Parallel Lane (m)	35	45	60	70	80	95	110	120
Deceleration Lane (m)	75	95	120	140	155	175	195	210
Deceleration Length (m)	55	70	90	105	118	135	153	165
Storage Lane 'S'	VARIABLE							

Table E10-1

Deceleration Lengths for Left Turn Lanes at Median Opening Design

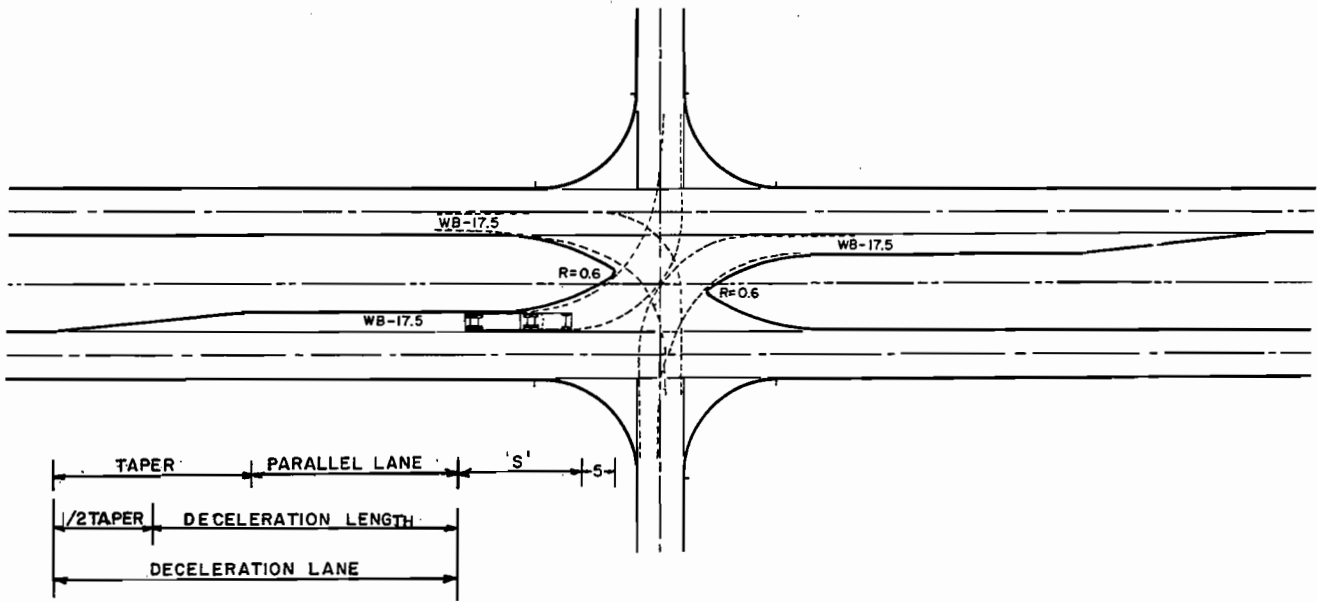

Figure E10-10

Design of Median Opening - Narrow Median
Bullet-Nose Design

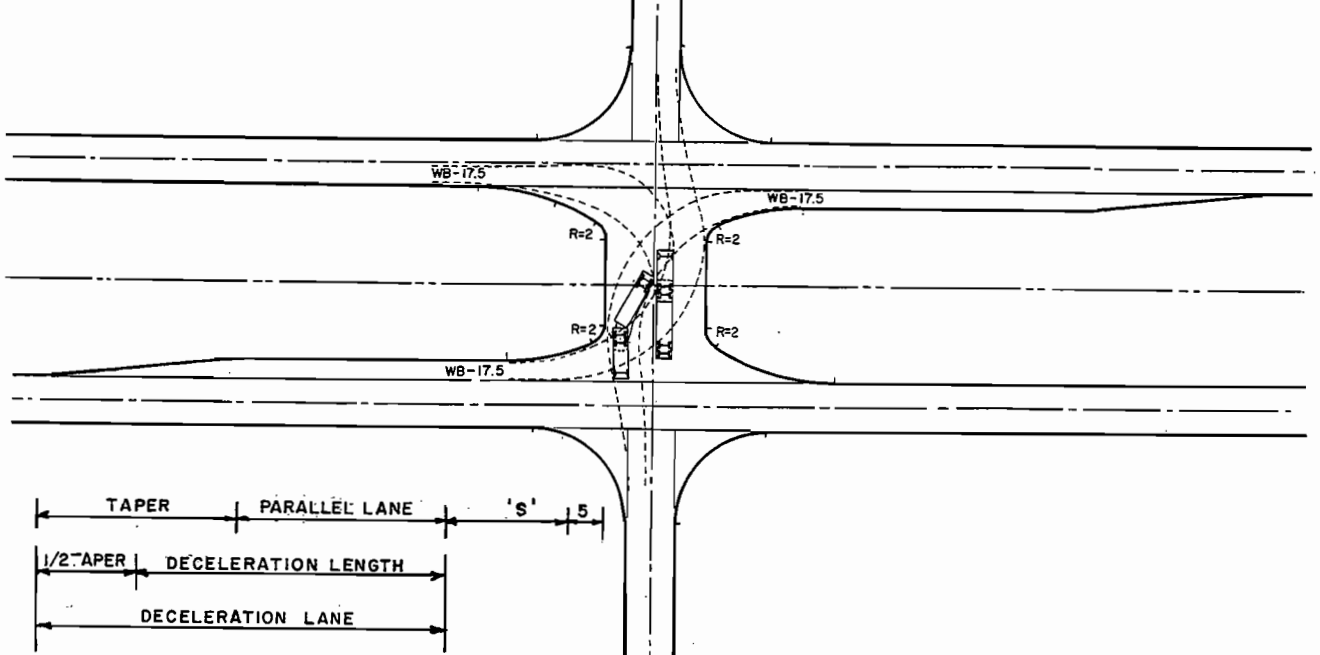

Figure E10-11

Design of Median Opening - Narrow Median
Flat-Nose Design

E.11 TRANSITION BETWEEN FOUR-LANE HIGHWAY AND TWO-LANE HIGHWAY AT INTERSECTIONS

Special consideration is given to the merging operation by providing increased taper lengths, since it is recognized that merging is more critical when drivers, missing the warning signs, may be surprised by the sudden lane drop. Length 'A' is required for signing purposes.

E.11.1 UNDIVIDED HIGHWAYS

E.11.2 DIVIDED HIGHWAYS

The lane arrangement for the transition from four-lane to two-lane and conversely from two-lane to four-lane highway is illustrated in Figure E11-1. The standard taper lengths for diverging and merging values are shown in Table E11-1, as well as the minimum and desirable parallel lane length 'A' beyond the intersection.

Principles similar to those used for undivided highways are employed in the initial design stages of a divided control access highway. See Figure E11-2 and E11-3.

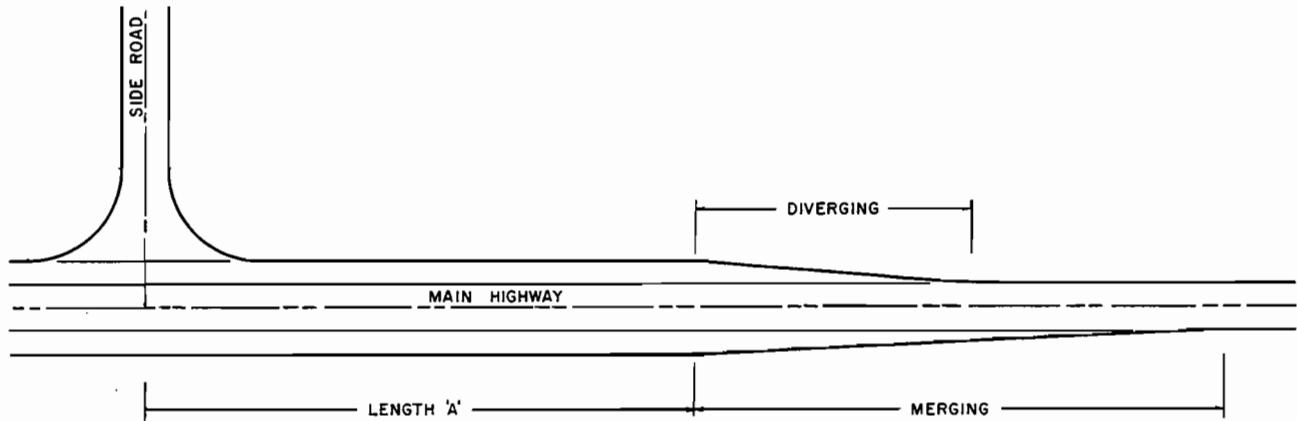

Figure E11-1

Transition Between Four-Lane Highway and Two-Lane Highway at Intersection

DESIGN SPEED km/h	LENGTH 'A'		MERGING	DIVERGING
	DESIRABLE LENGTH m	MIN.LENGTH	TAPER	TAPER
50	150	80	85	40
60	175	100	100	50
70	195	120	115	60
80	215	140	130	70
90	240	160	145	75
100	265	180	160	80
110	290	205	170	85
120	310	230	180	90

Table E11-1

Parallel Lane and Taper Lengths for Transition between Four-Lane Highway and Two-Lane Highway

DIVERGING 'C'	
D. SPEED Km/h	TAPER m
50	40
60	50
70	60
80	70
90	75
100	80
110	85
120	90

MERGING 'B'	
D. SPEED Km/h	TAPER m
50	85
60	100
70	115
80	130
90	145
100	160
110	170
120	180

LENGTH 'A'		
D. SPEED Km/h	DESIRABLE LENGTH m	MIN. LENGTH m
50	180	80
60	175	100
70	195	120
80	215	140
90	240	160
100	265	180
110	290	205
120	310	230

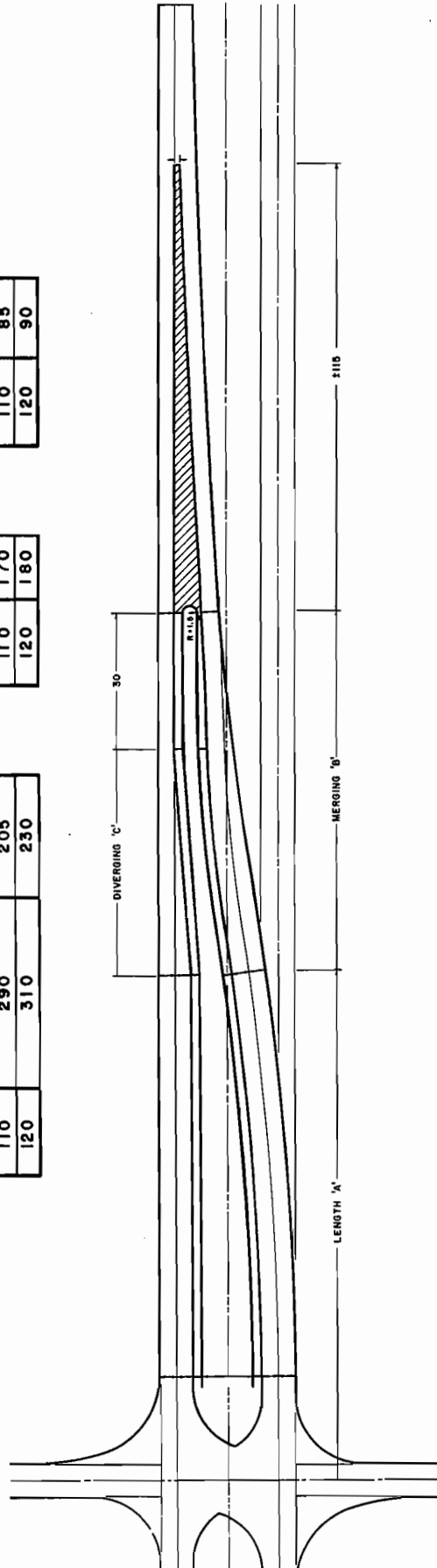

Figure E11-2
Transition between Four-Lane and Two-Lane Highway
Merge in Curved Alignment

DIVERGING 'C'	
D. SPEED Km/h	TAPER m
50	40
60	50
70	60
80	70
90	75
100	80
110	85
120	90

MERGING 'B'	
D. SPEED Km/h	TAPER m
50	85
60	100
70	115
80	130
90	145
100	160
110	170
120	180

LENGTH 'A'		
D. SPEED Km/h	DESIRABLE LENGTH m	MIN. LENGTH m
50	150	80
60	175	100
70	195	120
80	215	140
90	240	160
100	265	180
110	290	205
120	310	230

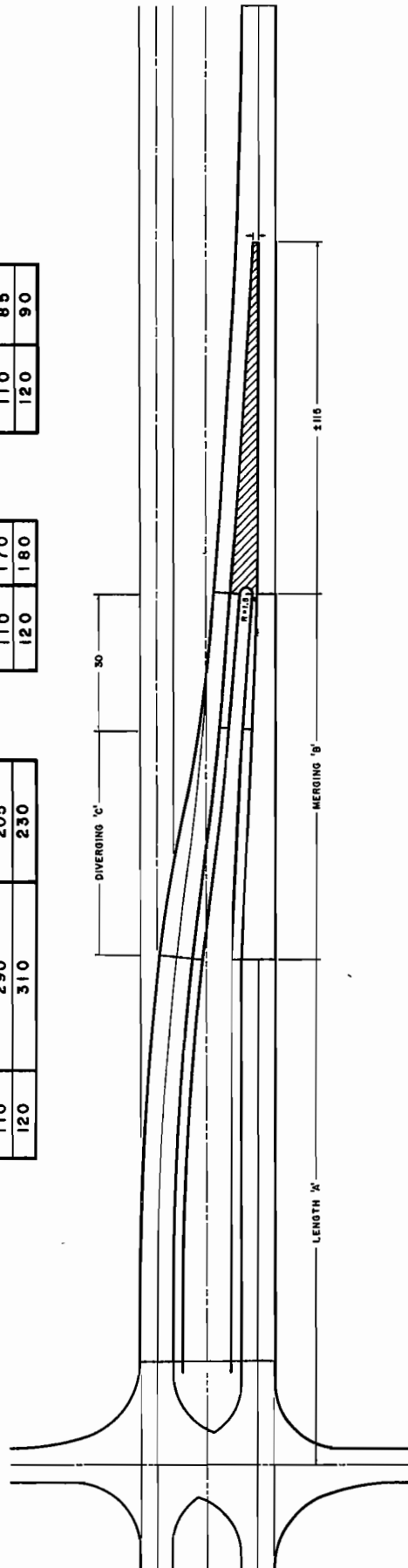

Figure E11-3
Transition between Four-Lane and Two-Lane Highway
Merge on Tangent Alignment

E.12 RAILWAY CROSSINGS AT-GRADE**E.12.1 RESTRICTIONS**

Wherever feasible, grade-separated crossings of railway lines are preferred.

The construction of a new railway grade crossing or the modification of an existing one is undertaken in terms of the National Transportation Agency of Canada "Regulations Respecting The Construction, Alteration And Maintenance Of Road Crossings At Grade". The design requires approval of the Agency and must meet the terms of The Railway Safety Act.

New public railway crossings (at-grade or grade-separated) may be authorized by the Agency at an existing road allowance or at any other location where road allowances have been established on each side of the railway right-of-way. The necessity for such a crossing is established by a Public Road Authority. The type of crossing and any additional protection that may be required is determined by the Agency.

Where an existing crossing requires reconstruction and modification of existing protection, such work is authorized by the Agency.

No proposed road crossing may depart from the standards set out in the Regulations except in accordance with an approval of the Minister of Transport granted under the provisions of section 10 of the Railway Safety Act.

E.12.2 VERTICAL ALIGNMENT

The grade of a road approaching a railway crossing should be flat to permit vehicles to stop safely when necessary and to proceed across without difficulty. The vertical alignment should produce acceptable geometrics necessary to prevent low-clearance vehicles from becoming caught on the tracks, therefore, providing the crossing surface at the same plane as the top of the rails for a distance of one metre outside of the rails. The approach grade of the highway should also not be more than + 1%, nor less than - 2% from the top of the nearest rail at a point 10 m from the rail unless track superelevation dictates otherwise. Section 10 of the Railway Safety Act should be consulted for specific controls of the road approach gradients.

The grade of the approach of any grade crossing must be in accordance with Part (2) of Section 10 of The Railway Safety Act.

"The inclination of the ascent or descent, as the case may be, of any approach by which the road is carried across any rail line at rail level, at all public road crossings constructed or reconstructed before the coming into force of these Regulations, shall not exceed a vertical to horizontal ratio of 1:20 (5 per cent), unless authorized by the Agency prior to January 1, 1989."

E.12.3 HORIZONTAL ALIGNMENT

The presence of a railway crossing influences the horizontal alignment of a road. The crossing should be made as nearly as possible at right angles to provide maximum available sight distance along the track in both directions from both approaches. Any departure from a right-angle crossing should be considered in the light of its influence on sight distance and in consideration of train speed, road speed and protective devices.

Section 10 of the Railway Safety Act should be referred to for specific controls.

E.12.4 WIDTH OF CROSSING

The crossing width must conform to the latest requirements of General Order E-4 of the Canadian Transport Commission.

"Unless otherwise ordered by the Committee, when a crossing other than a pedestrian crossing is constructed, the crossing shall...have a width of (a) 8m, or (b) the width of the highway and shoulders, as measured at the approaches to the crossing, whichever is the greater."

E.12.5 VISIBILITY

For sight distance requirements see section E.3.6.

E.12.6 PROTECTION AT CROSSINGS

The following protection devices are used at railway grade crossings.

Basic protection devices:

- reflectorized crossbuck signs (responsibility of railway companies)
- warning signs on road in advance of crossing (responsibility of road authorities)
- pavement markings ahead of crossing (responsibility of road authorities)

Automated signals with or without gates:

- flashing lights and bells are used when there are three or more regular trains per day and fewer than 1000 vehicles per day.
- flashing lights, bells and automatic gates are used when the road speed is 100 km/h or over in a rural zone, or 60 km/h or over in an urban area and when there is a double track to cross, the train speed is 100 km/h or less, and there are 12 or more trains per day.

Regular traffic signals with pre-empting periods:

- when a railway grade crossing on an urban street is within 60 m of a high volume street intersection, traffic signals are required at the nearby intersections. This installation is subject to the approval of the Canadian Transport Commission and conforms with its requirements.

The signals are interconnected with the warning circuits of the railway tracks to change the signal sequence. The circuits energize red lenses toward the crossing during the period of train obstruction. The pre-empting circuit ties with the railway blocks signals and have an advance of at least 25s.

Details of the railway advance warning sign and pavement markings ahead of the crossing are given in "Uniform Traffic Control Devices for Canada" (Reference 35).

For further information on installation at railway crossings, refer to "Contract Design, Estimating and Documentation" manual.

An additional measure to increase safety at a grade crossing is illumination. Lighting railway crossings at-grade should be considered when there are train movements at night.

E.A.1 LEFT TURN LANE WARRANTS AND STORAGE LANE LENGTHS FOR TWO-LANE HIGHWAYS; UNSIGNALIZED INTERSECTIONS

Left turn lane warrants and storage lane lengths for unsignalized intersections are based on turning, advancing and opposing design hour volumes, which are shown on the example of the DHV turning volume diagram, see Figure EA-1, and are determined from the warrant graphs in Figures EA-2 to EA-29.

The design charts have been based on passenger car dimensions and operating characteristics.

The minimum storage length that should be provided is 15 m from practical design considerations alone. 15 m would provide adequate storage for two vehicles.

USE OF GRAPHS

Select proper graph by percentage of left turns in Advance Volume, V_A , and design

speed in kilometres per hour.

If the intersection of lines projected from Advancing Volume, V_A , and Opposing Volume, V_O , fall to the left of the warrant line, a left turn lane is not required.

Right of the warrant line, 'S', indicates the length of the storage lane in metres. If the percentage of trucks in the left turning traffic is more than 10% see Table E9-3 and add the table value to storage lane length.

The charts also indicate conditions where the combination of advancing and opposing traffic may warrant traffic signals. A warrant for traffic signals may occur when no warrant for left turn storage lanes exist due to the requirements of the side road traffic.

On approaches where a separate turning lane is provided for right-turning traffic, the right turns are not included in the determination of V_A or V_O as the case may be.

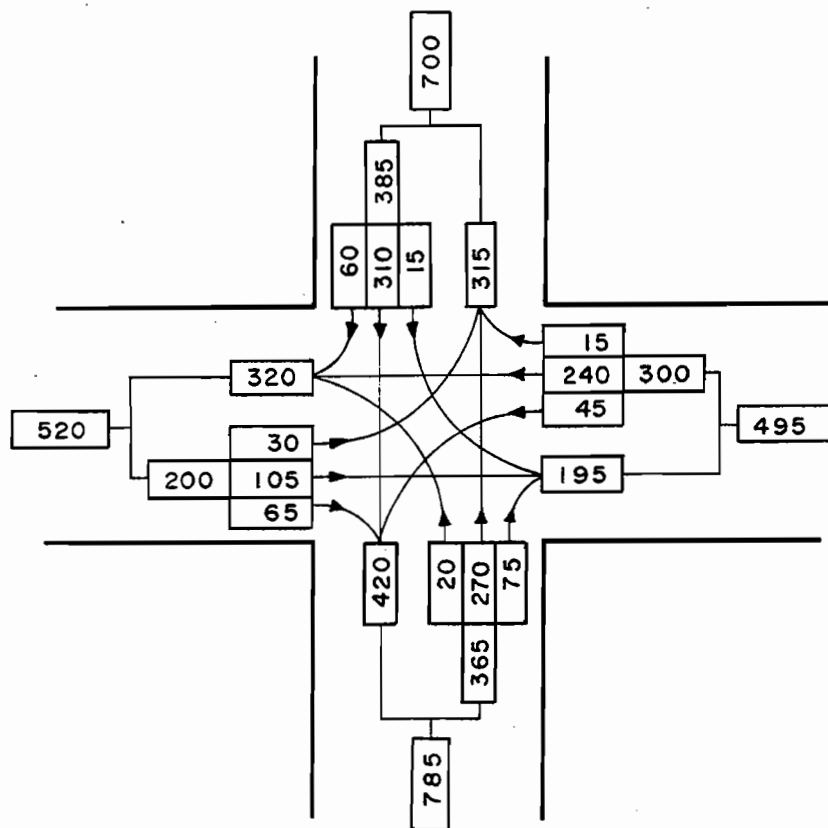

Figure EA-1

**Design Hour Volume (DHV)
Turning Volume Diagram**

The following example 1 relates to the turning volume diagram in Figure EA-1 and left turn storage lane chart Figure EA-3.

EXAMPLE 1

Design Speed = 50 km/h
 Advancing Traffic Volume, $V_A = 300$ vph
 Opposing Traffic Volume, $V_O = 200$ vph
 Left Turn Traffic Volume, $V_L = 45$ vph

Percentage of Left Turning Traffic:

$$\frac{45 \times 100}{300} = 15(\%)$$

The projected lines intersect to the left of the warrant line and hence no left turn lane is needed. Also the lines intersect to the left of the traffic signal warrant line indicating that traffic signals are not required.

Example 2. The traffic volumes and derived left turning traffic percentage of 30% are applied to Figure EA-24.

EXAMPLE 2

Design Speed = 100 km/h
 Advancing Traffic Volume, $V_A = 400$ vph
 Opposing Traffic Volume, $V_O = 300$ vph
 Left Turning Traffic Volume, $V_L = 120$ vph

Percentage of Left Turning Traffic:

$$\frac{120 \times 100}{400} = 30(\%)$$

The value in the graph indicates that the length of the left turn storage lane 'S' should be 25 m.

If the percentage of trucks in the left turn lane is 20%, see table E9-3 for additional storage length and add the value to the left turn lane; $25 \text{ m} + 10\text{m} = 35 \text{ m}$.

Since the lines intersect to the right of the short dash line and to the left of the long dash line, therefore traffic signals may be warranted in "free-flow" urban areas only.

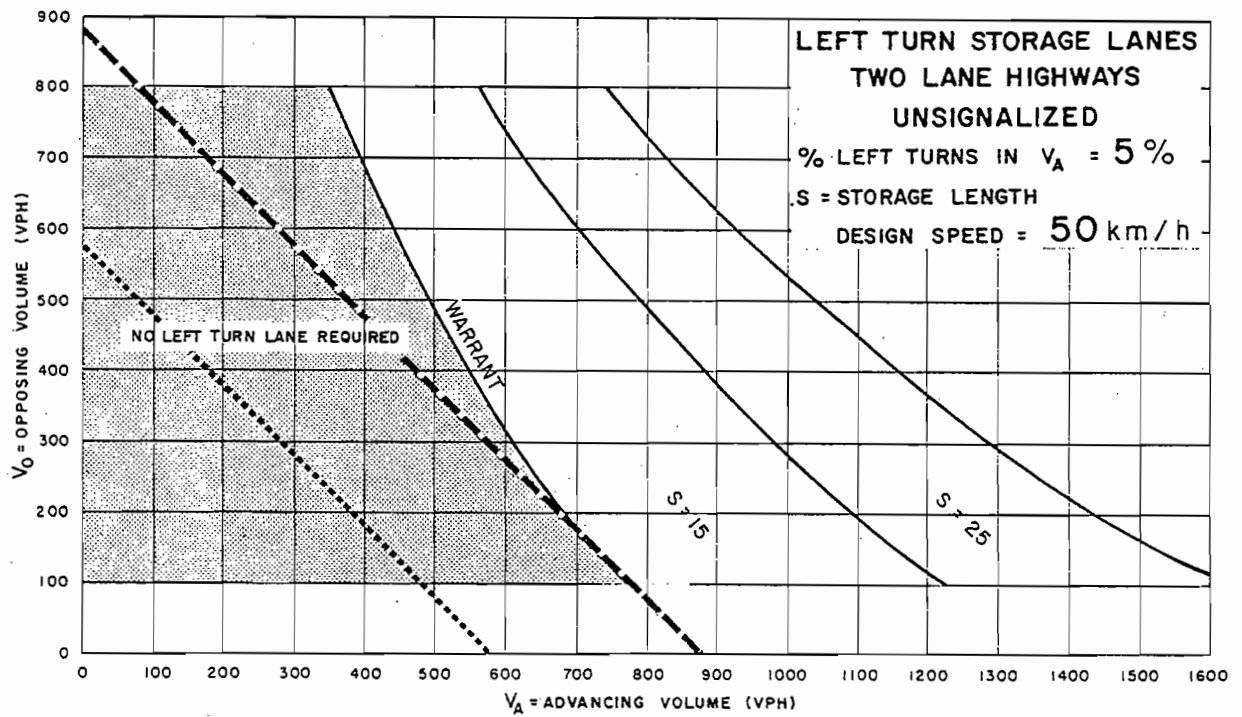

--- TRAFFIC SIGNALS MAY BE WARRANTED IN RURAL AREAS OR URBAN AREAS WITH RESTRICTED FLOW

..... TRAFFIC SIGNALS MAY BE WARRANTED IN "FREE FLOW" URBAN AREAS

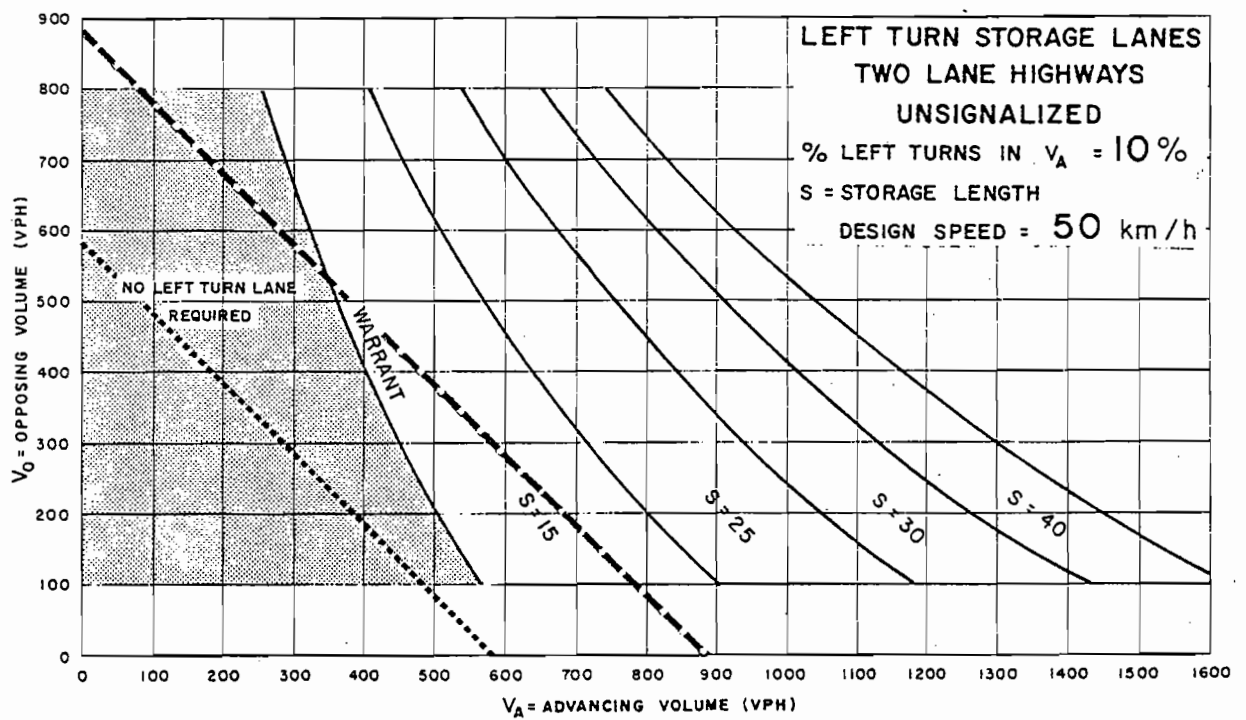
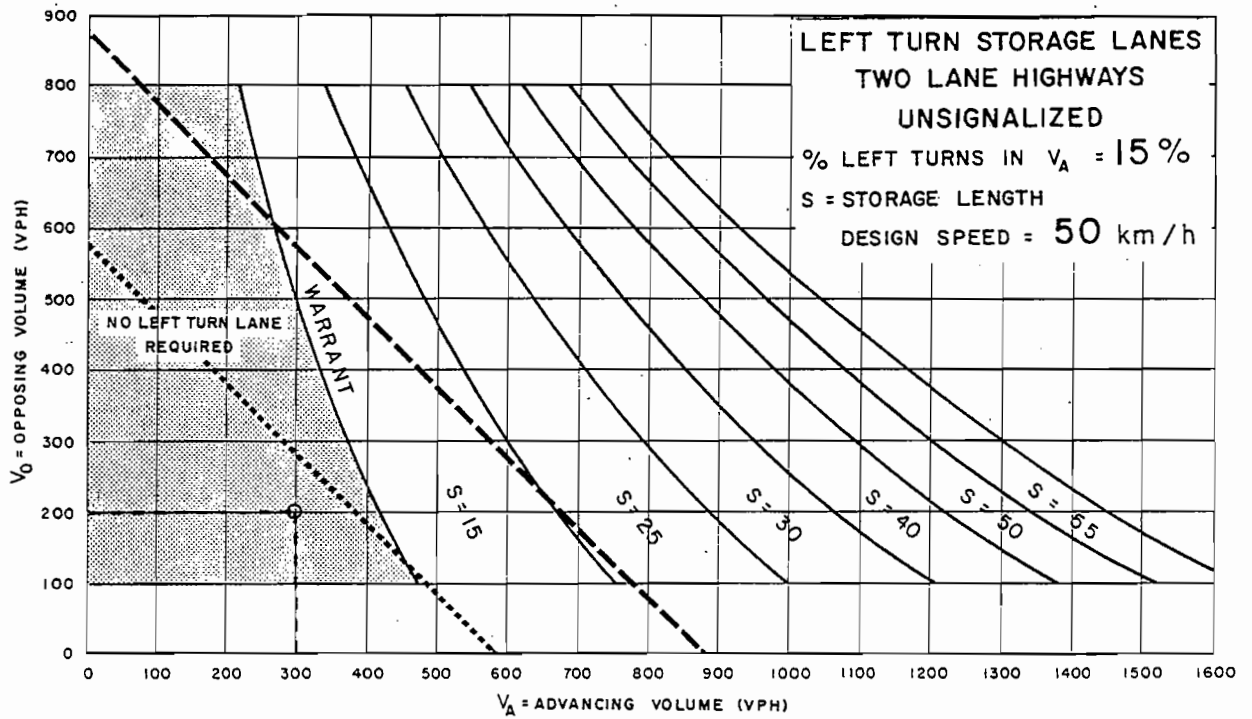

Figure EA-2



--- TRAFFIC SIGNALS MAY BE WARRANTED IN RURAL AREAS OR URBAN AREAS WITH RESTRICTED FLOW

..... TRAFFIC SIGNALS MAY BE WARRANTED IN "FREE FLOW" URBAN AREAS

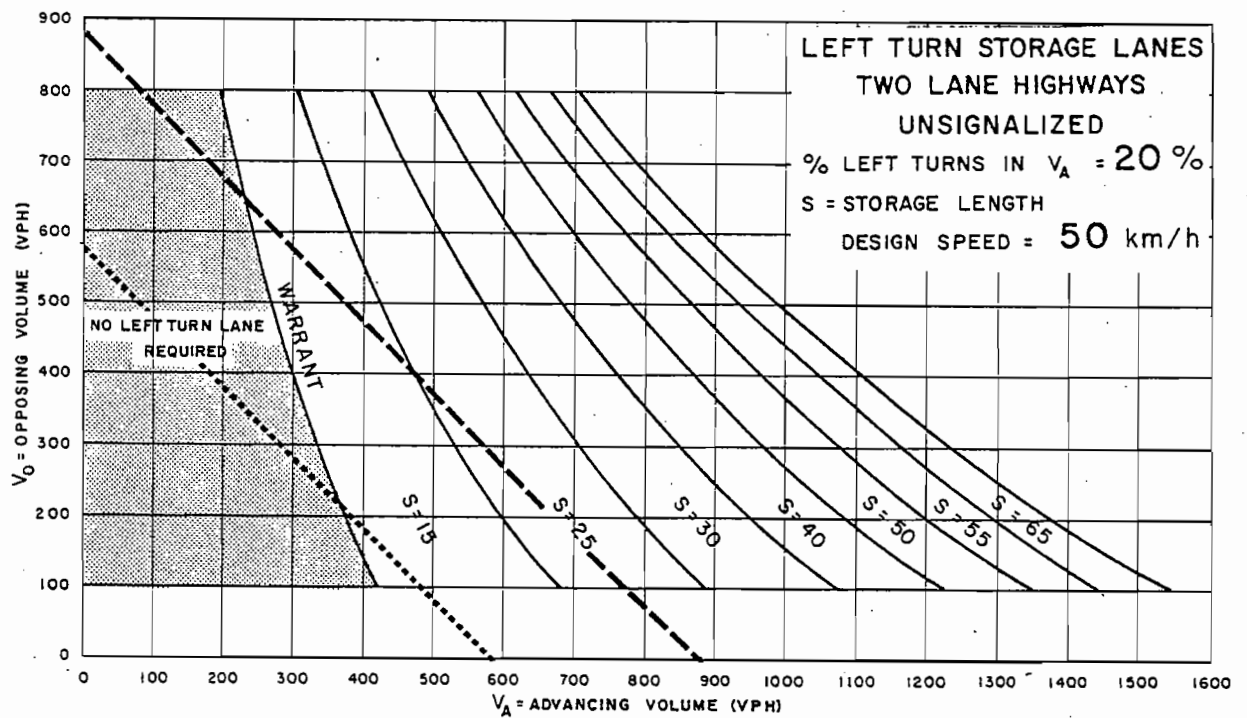
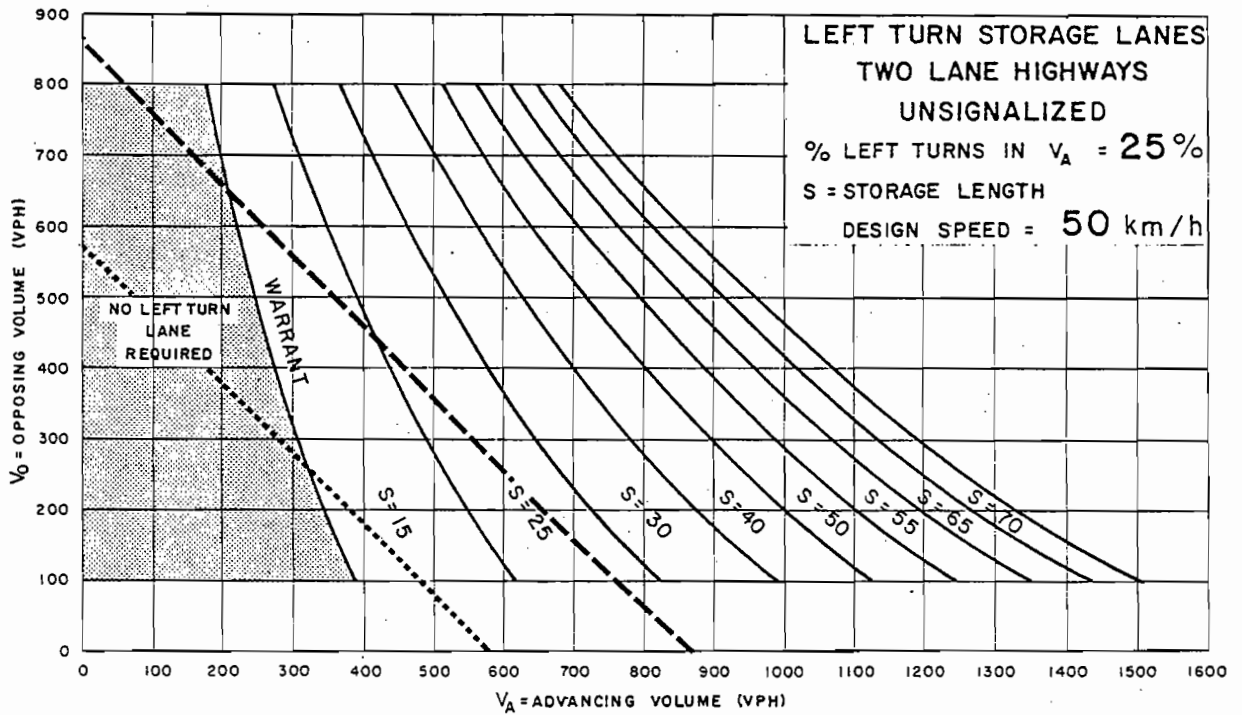

Figure EA-3



--- TRAFFIC SIGNALS MAY BE WARRANTED IN RURAL AREAS OR URBAN AREAS WITH RESTRICTED FLOW
 TRAFFIC SIGNALS MAY BE WARRANTED IN "FREE FLOW" URBAN AREAS

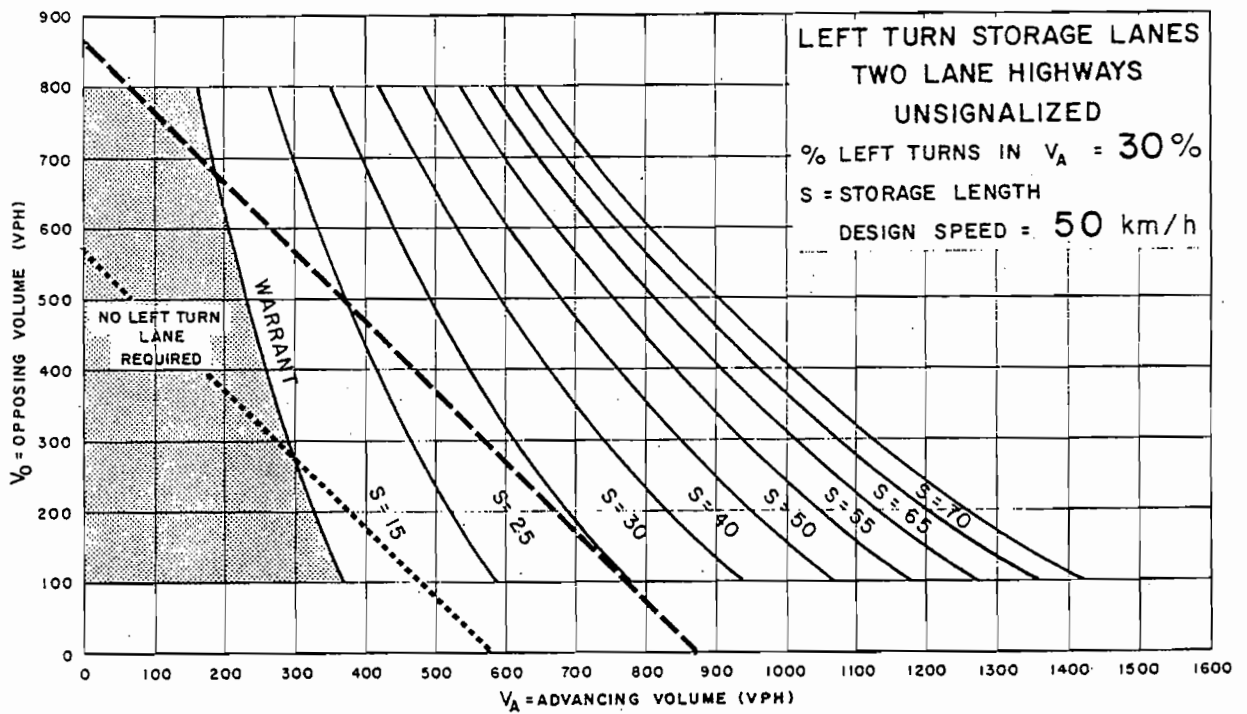
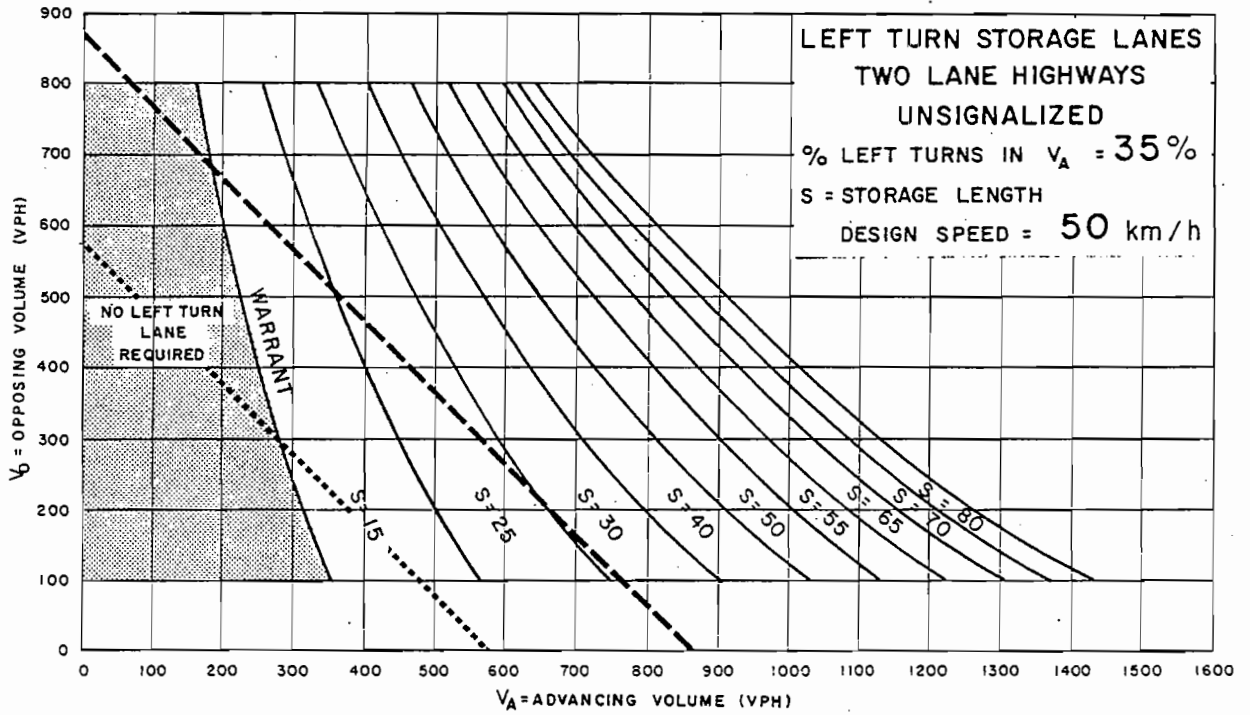

Figure EA-4



--- TRAFFIC SIGNALS MAY BE WARRANTED IN RURAL AREAS OR URBAN AREAS WITH RESTRICTED FLOW

..... TRAFFIC SIGNALS MAY BE WARRANTED IN "FREE FLOW" URBAN AREAS

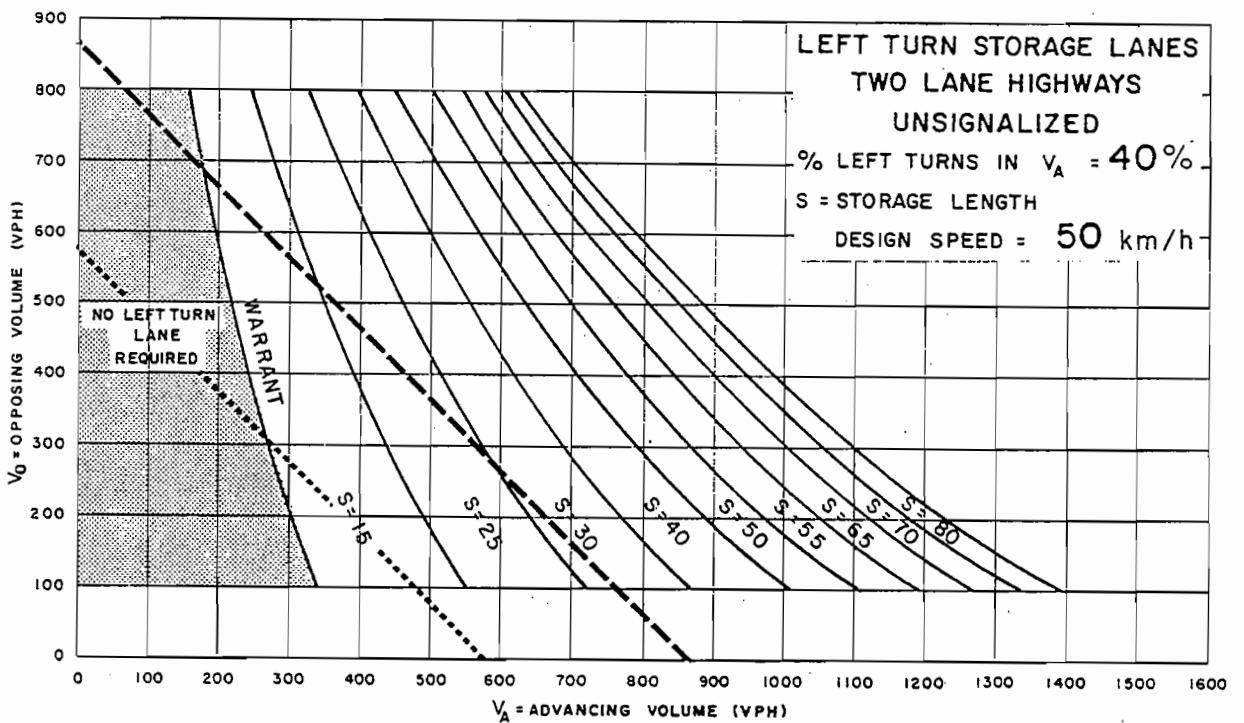
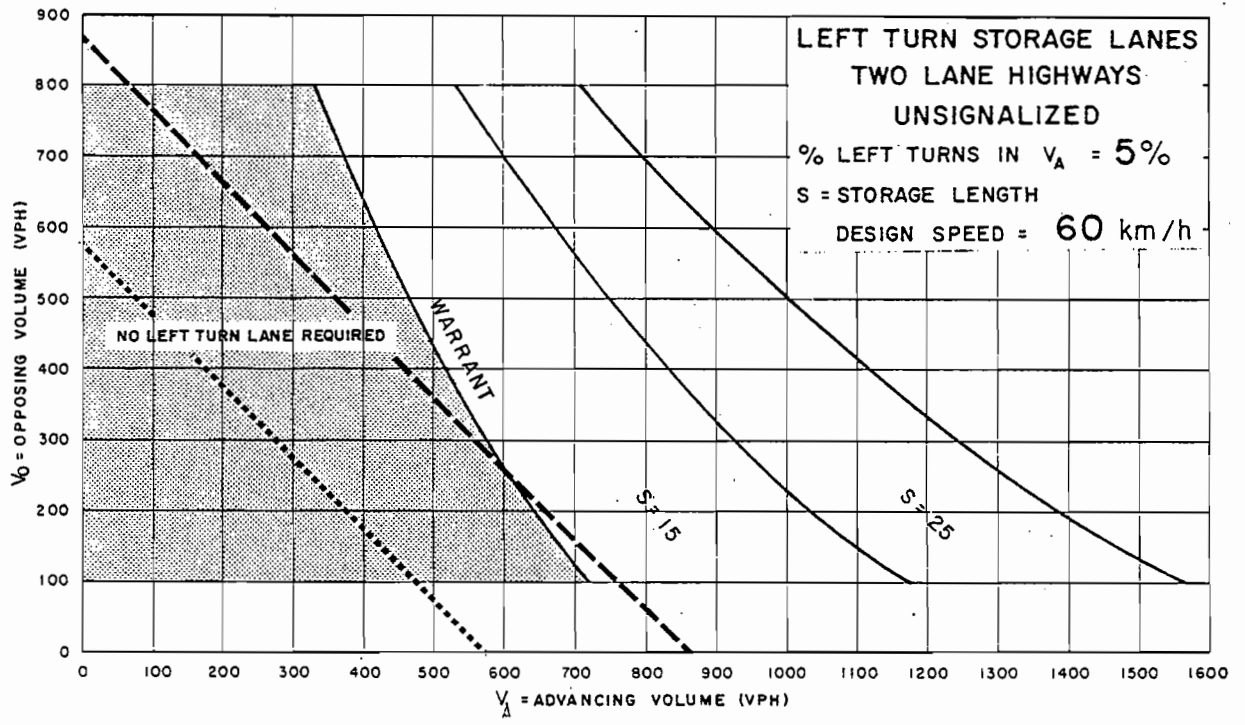

Figure EA-5



--- TRAFFIC SIGNALS MAY BE WARRANTED IN RURAL AREAS OR URBAN AREAS WITH RESTRICTED FLOW
 TRAFFIC SIGNALS MAY BE WARRANTED IN "FREE FLOW" URBAN AREAS

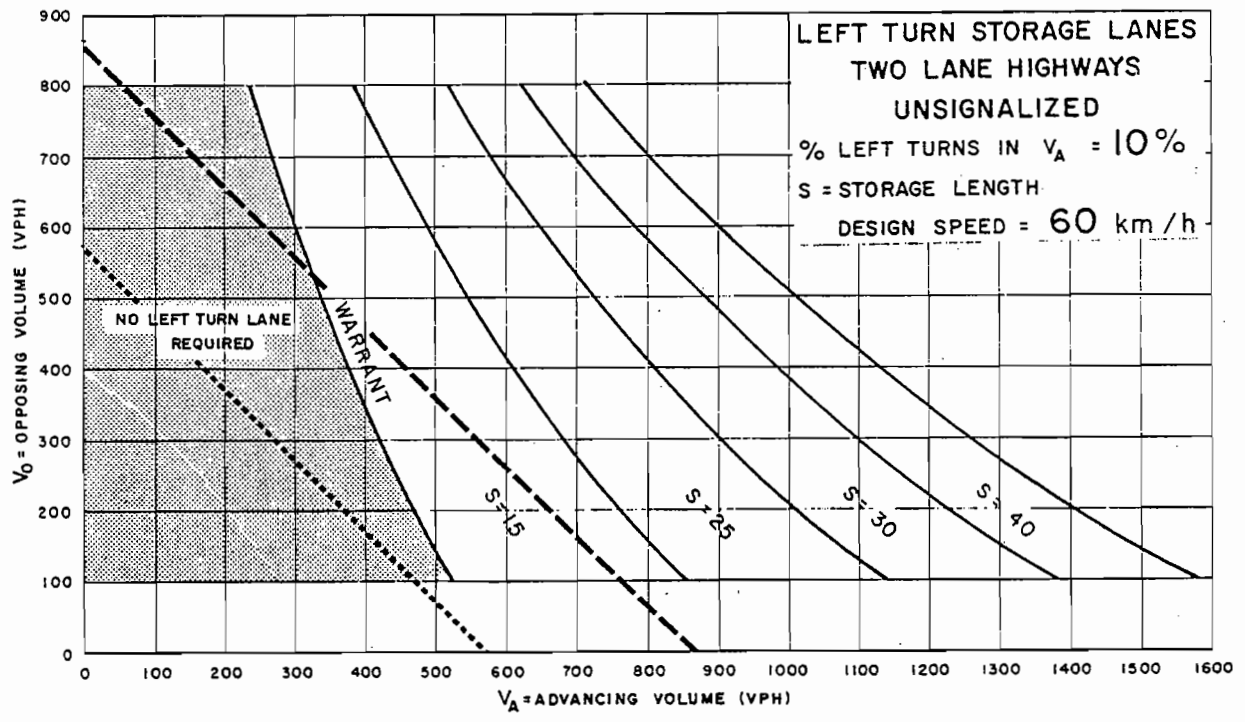
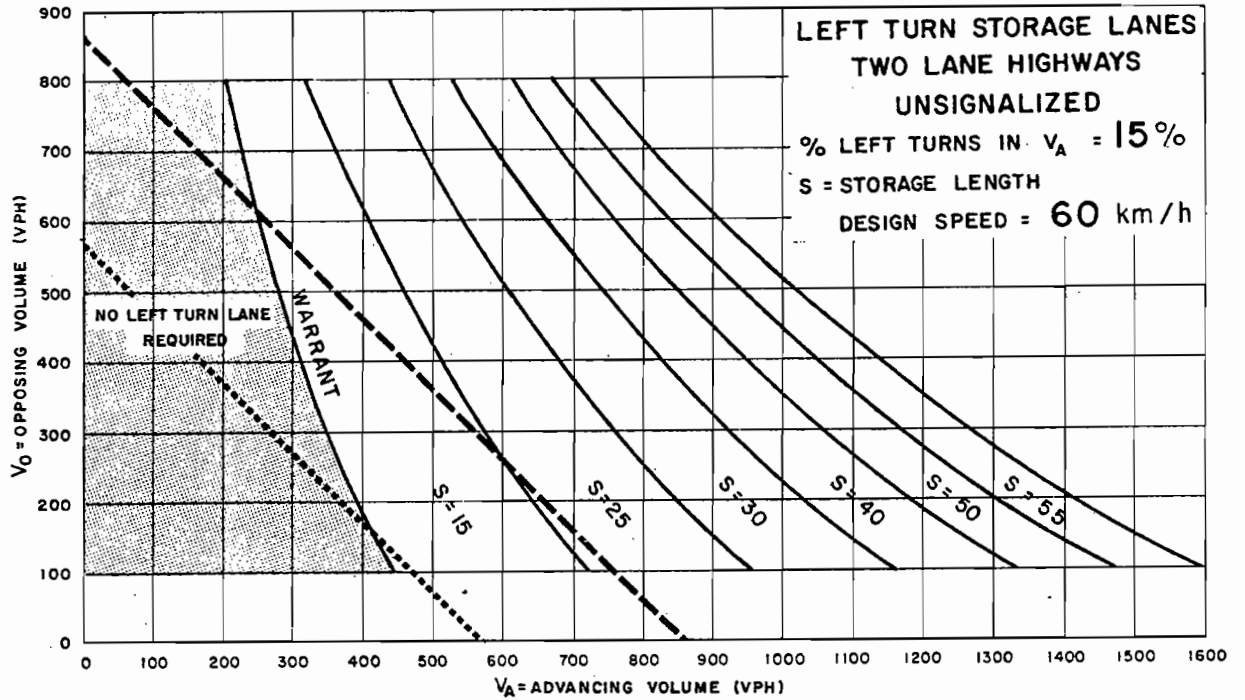

Figure EA-6



----- TRAFFIC SIGNALS MAY BE WARRANTED IN RURAL AREAS OR URBAN AREAS WITH RESTRICTED FLOW

..... TRAFFIC SIGNALS MAY BE WARRANTED IN "FREE FLOW" URBAN AREAS

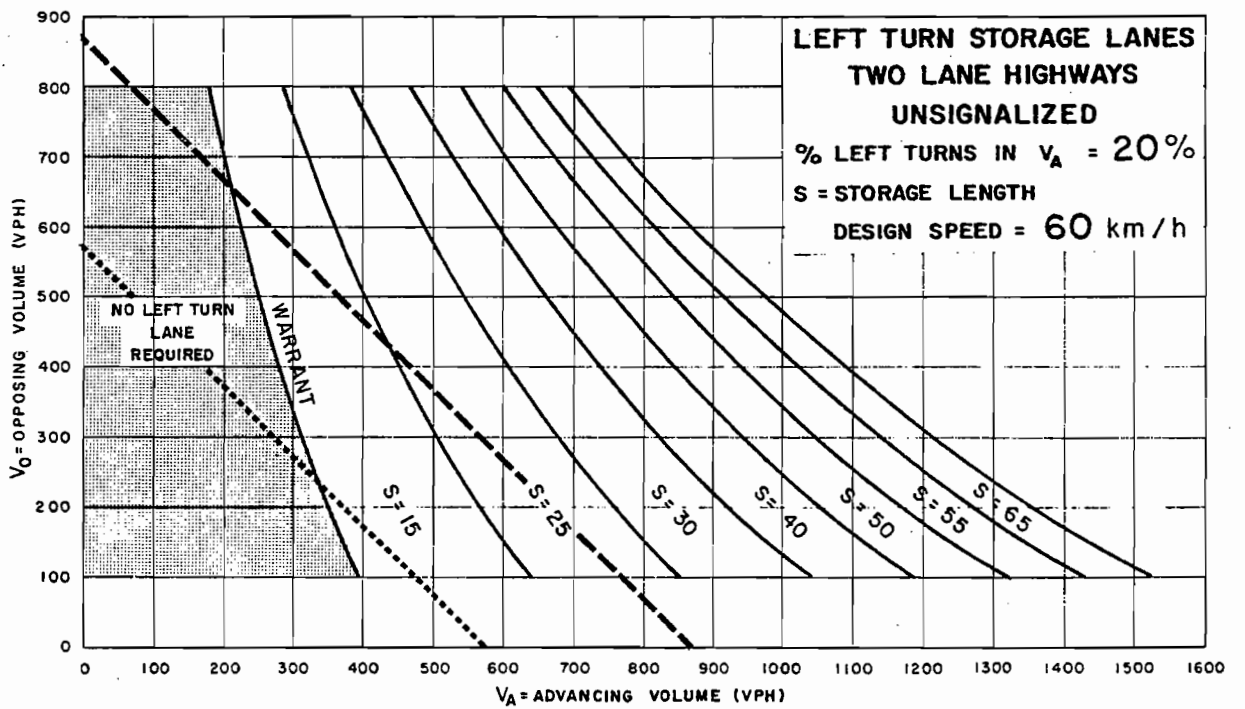

Figure EA-7

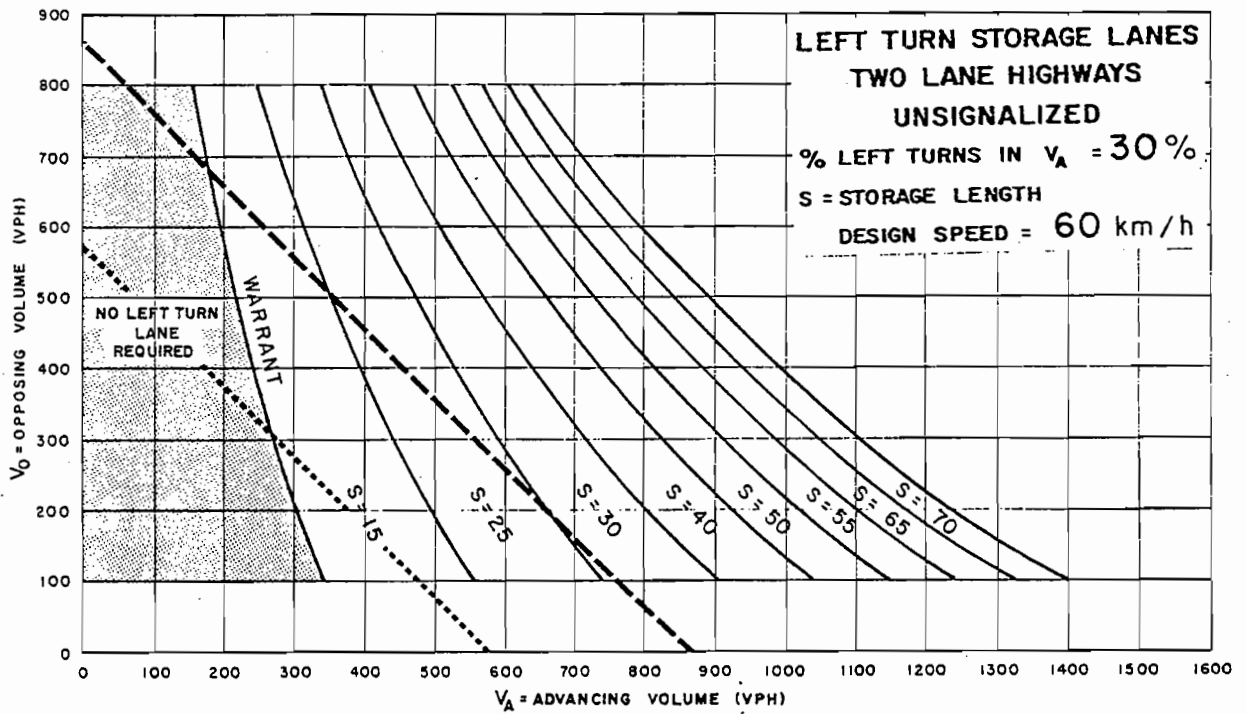
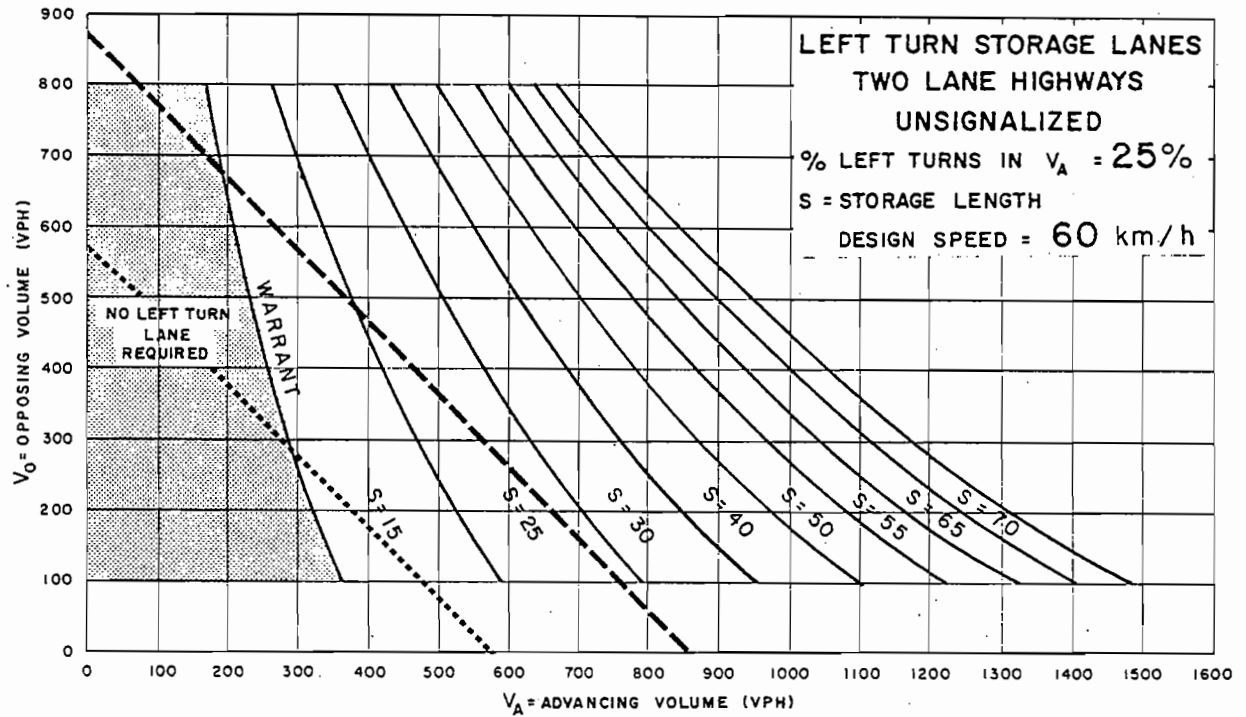

Figure EA-8

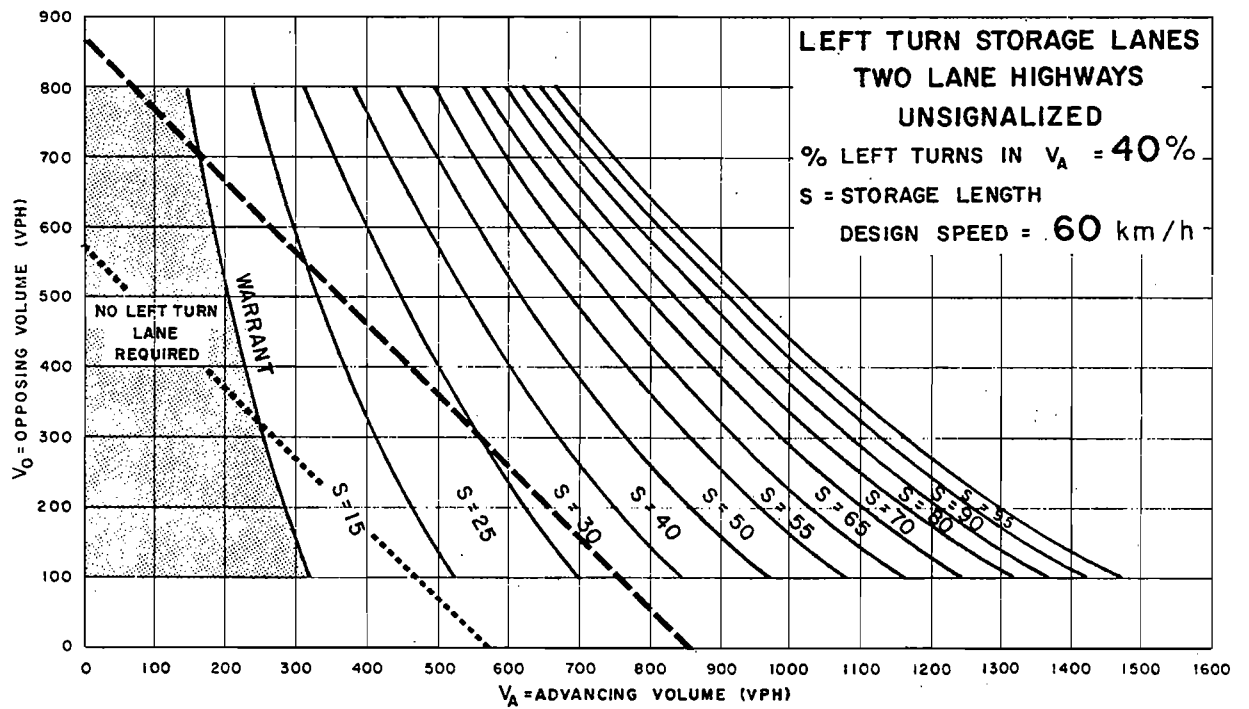
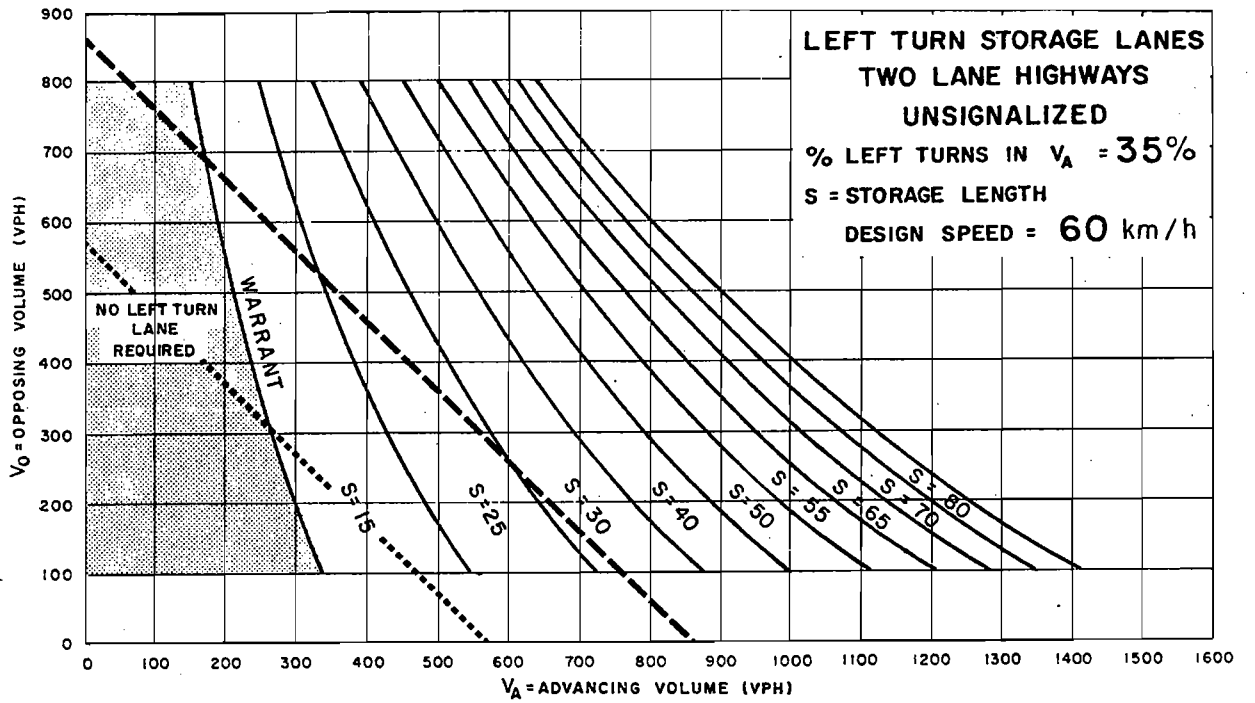
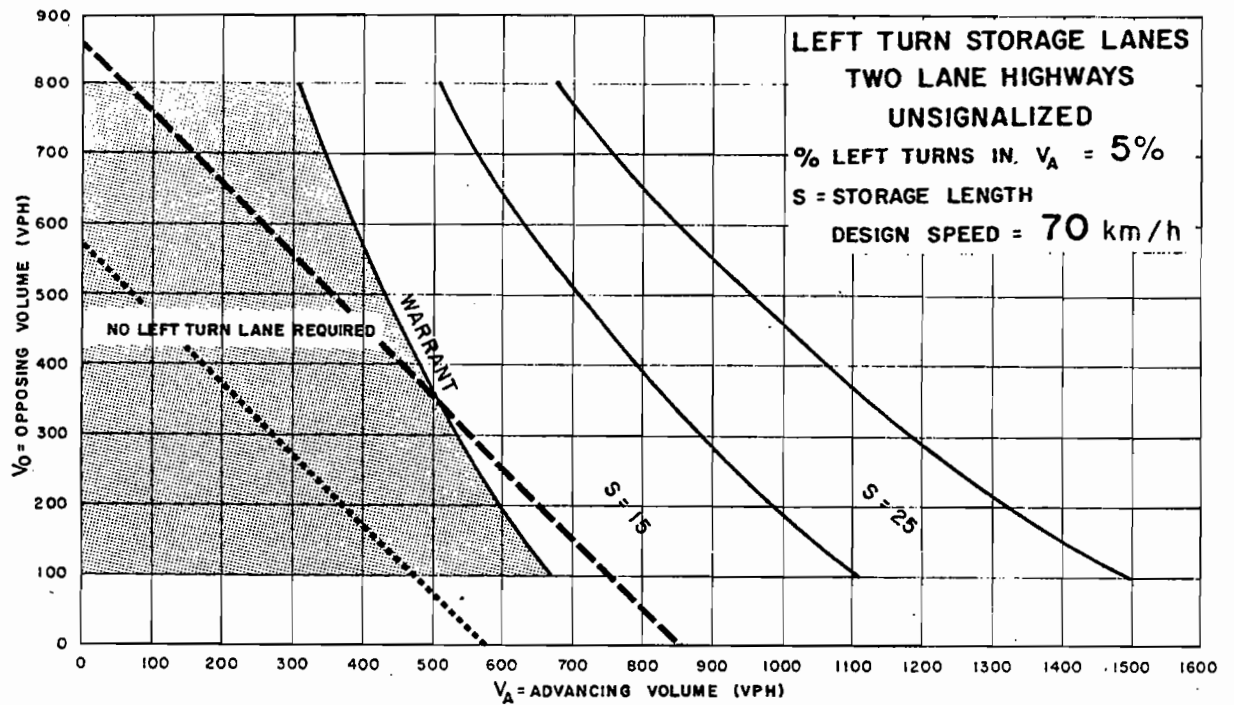

Figure EA-9



----- TRAFFIC SIGNALS MAY BE WARRANTED IN RURAL AREAS OR URBAN AREAS WITH RESTRICTED FLOW

..... TRAFFIC SIGNALS MAY BE WARRANTED IN "FREE FLOW" URBAN AREAS

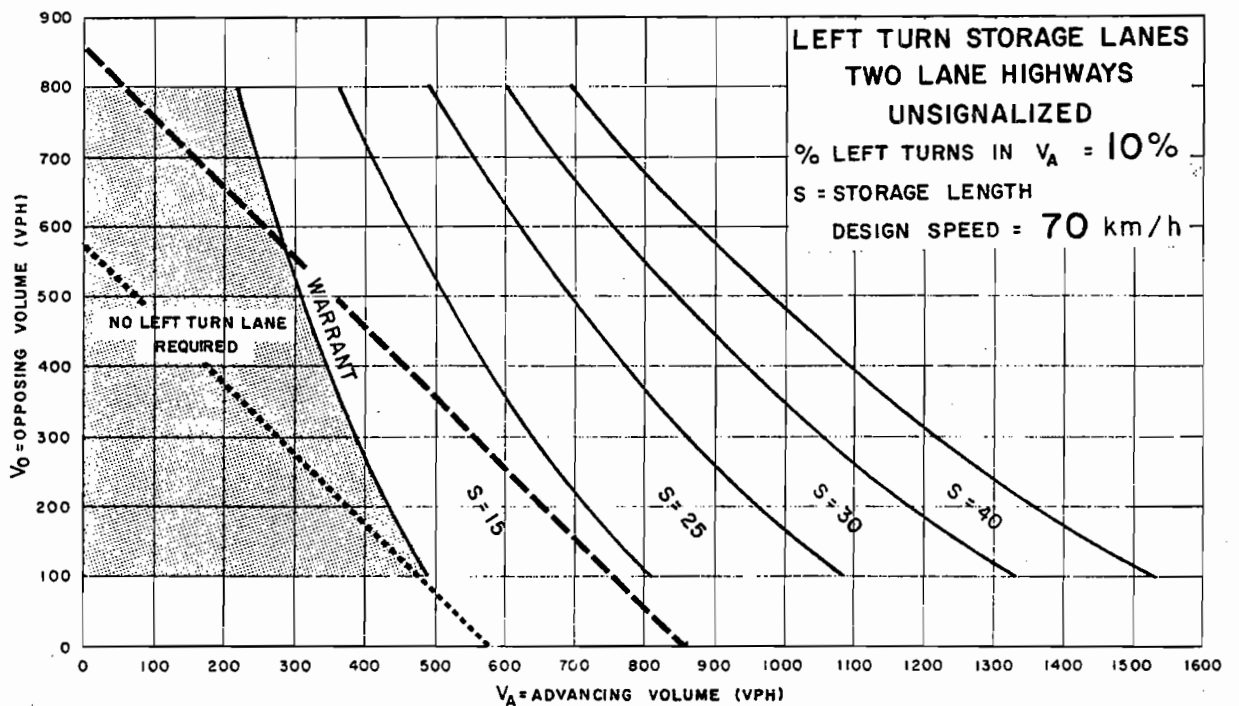
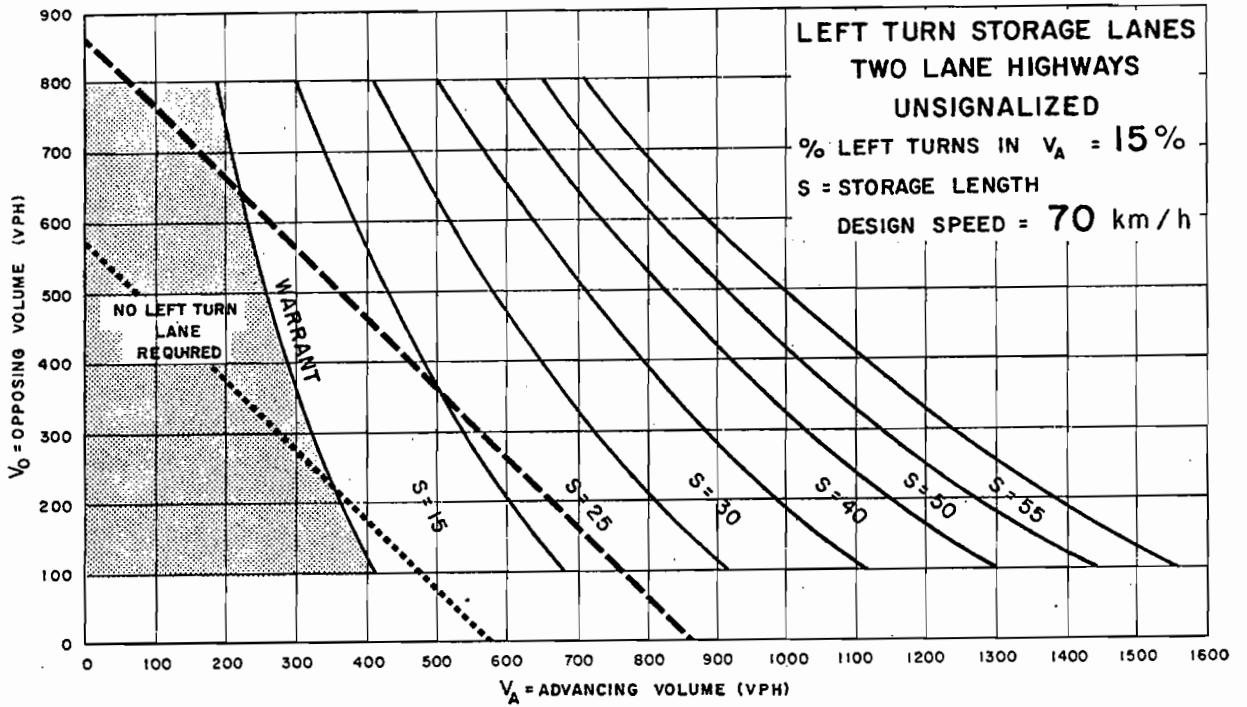

Figure EA-10



--- TRAFFIC SIGNALS MAY BE WARRANTED IN RURAL AREAS OR URBAN AREAS WITH RESTRICTED FLOW

..... TRAFFIC SIGNALS MAY BE WARRANTED IN "FREE FLOW" URBAN AREAS

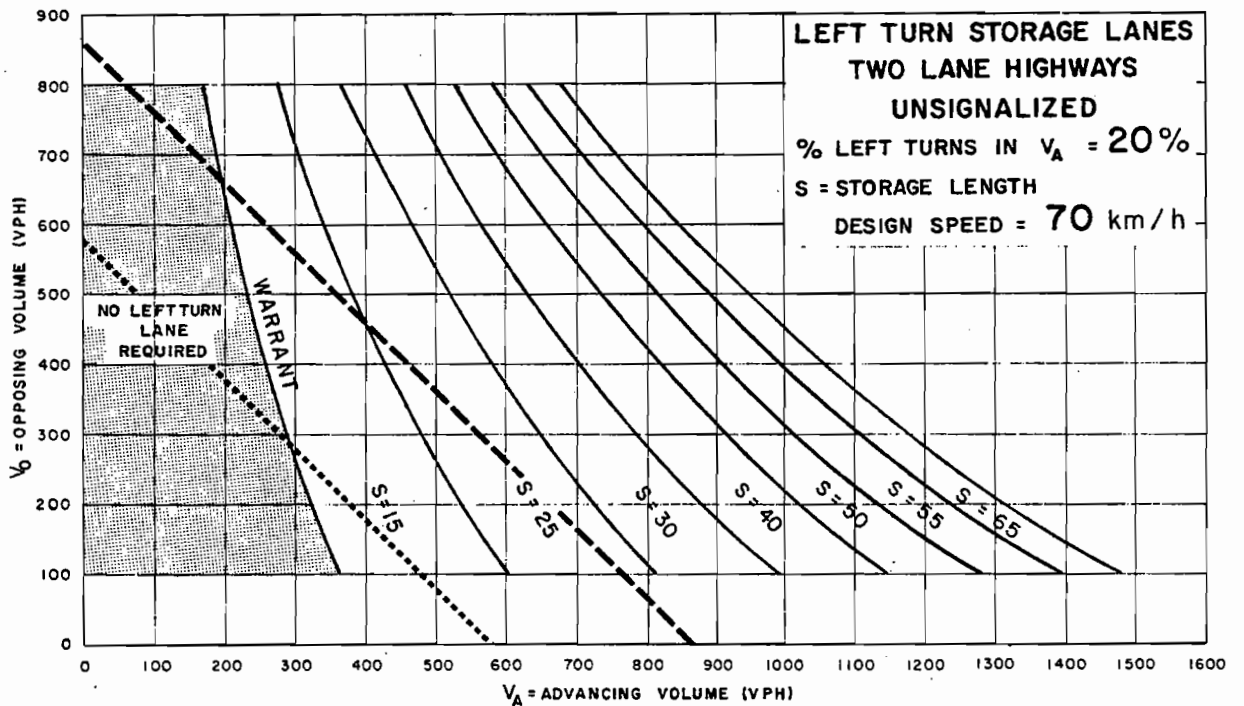

Figure EA-11

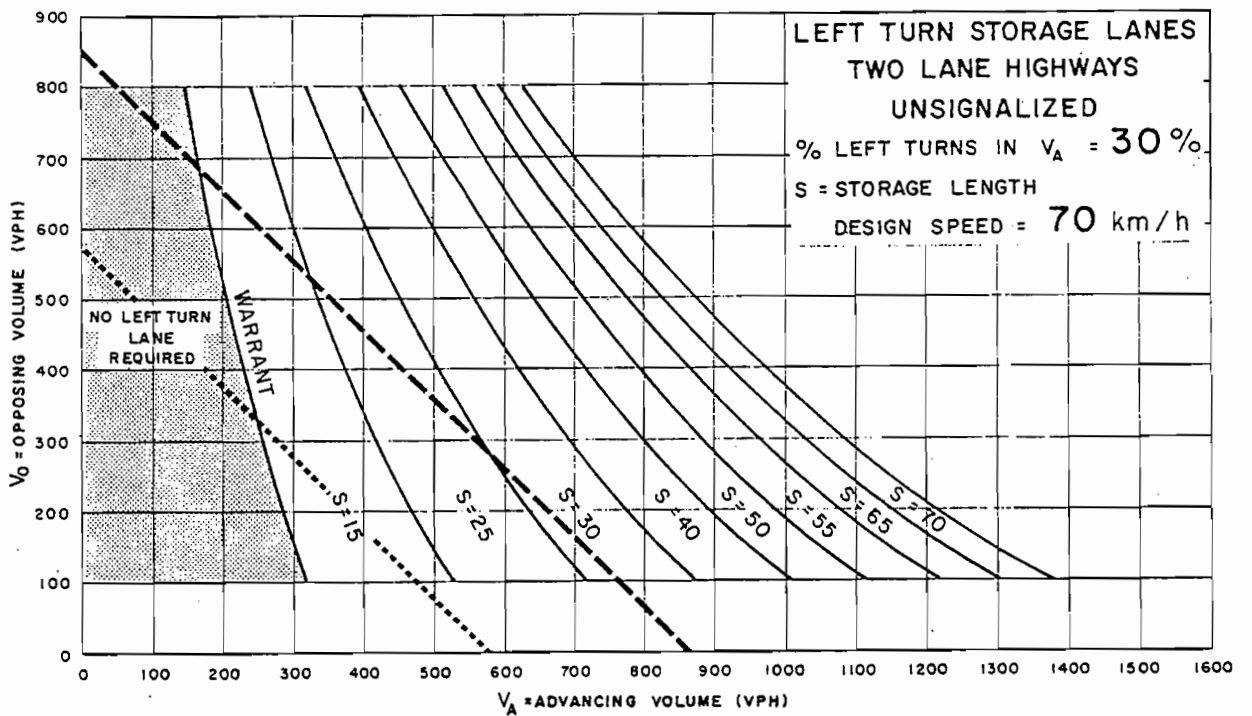
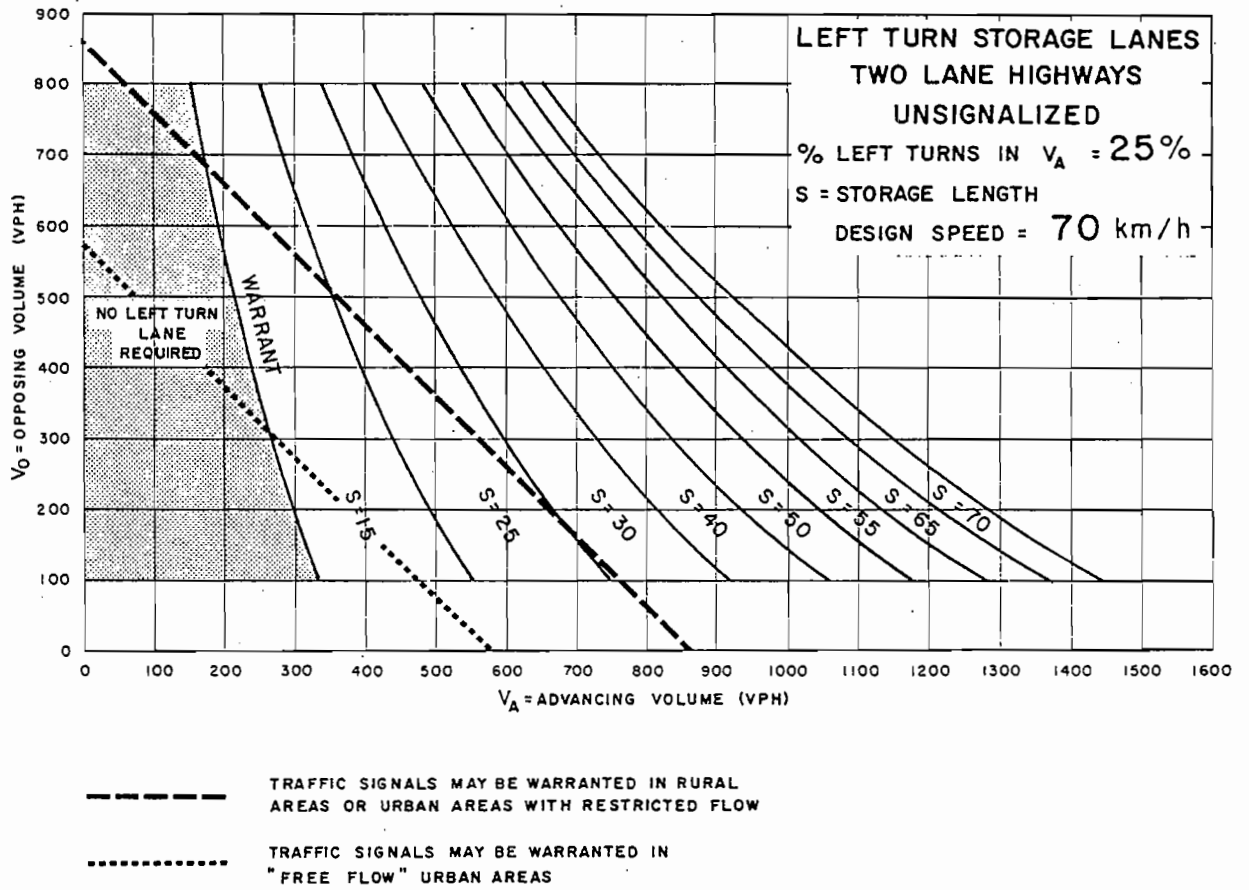
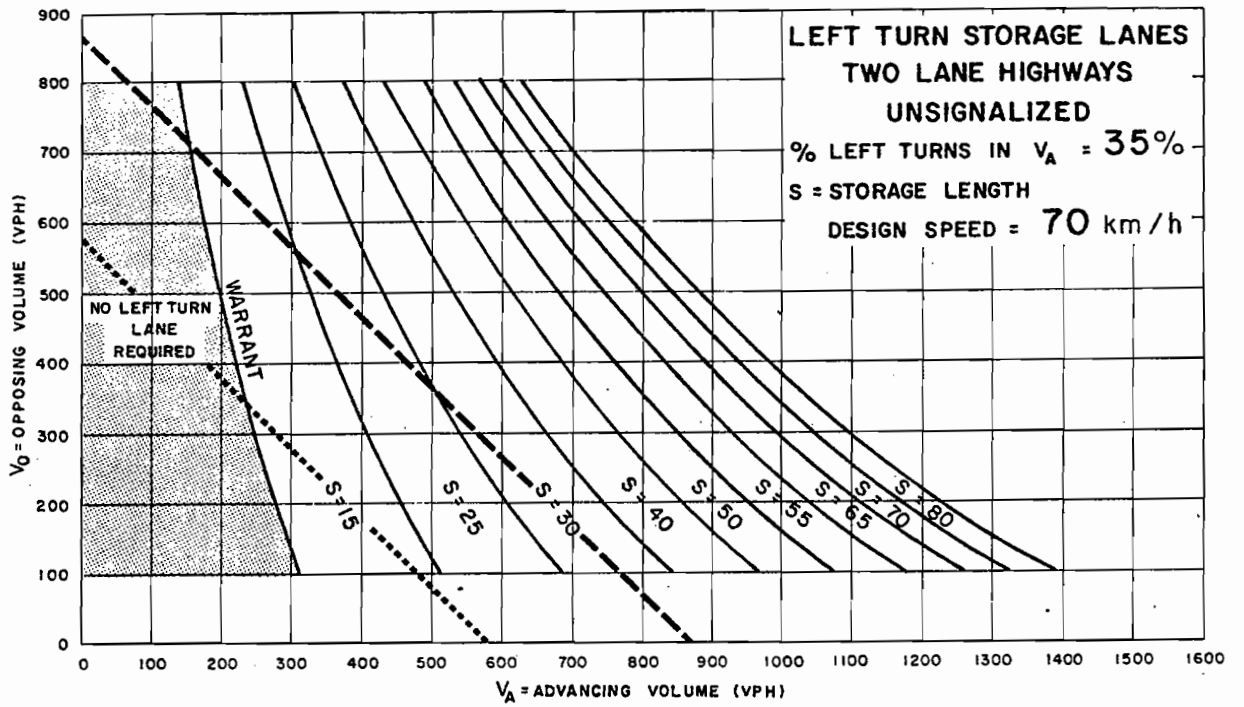

Figure EA-12



--- TRAFFIC SIGNALS MAY BE WARRANTED IN RURAL AREAS OR URBAN AREAS WITH RESTRICTED FLOW

..... TRAFFIC SIGNALS MAY BE WARRANTED IN "FREE FLOW" URBAN AREAS

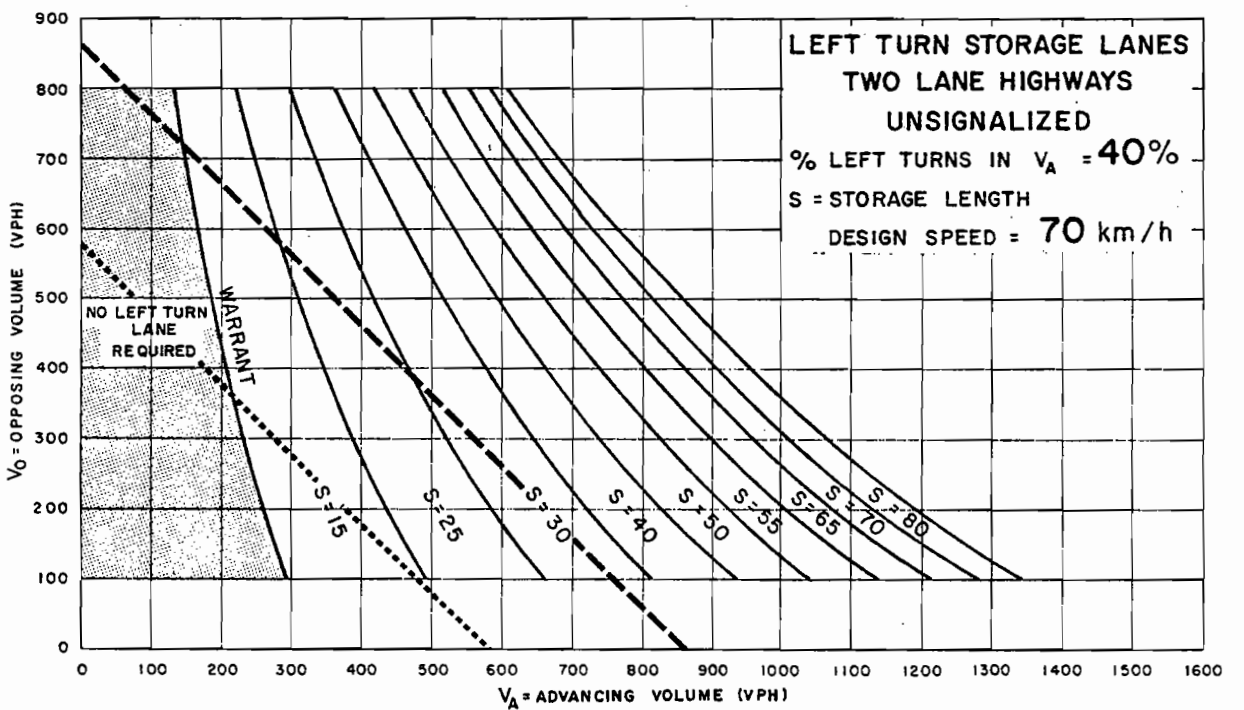

Figure EA-13

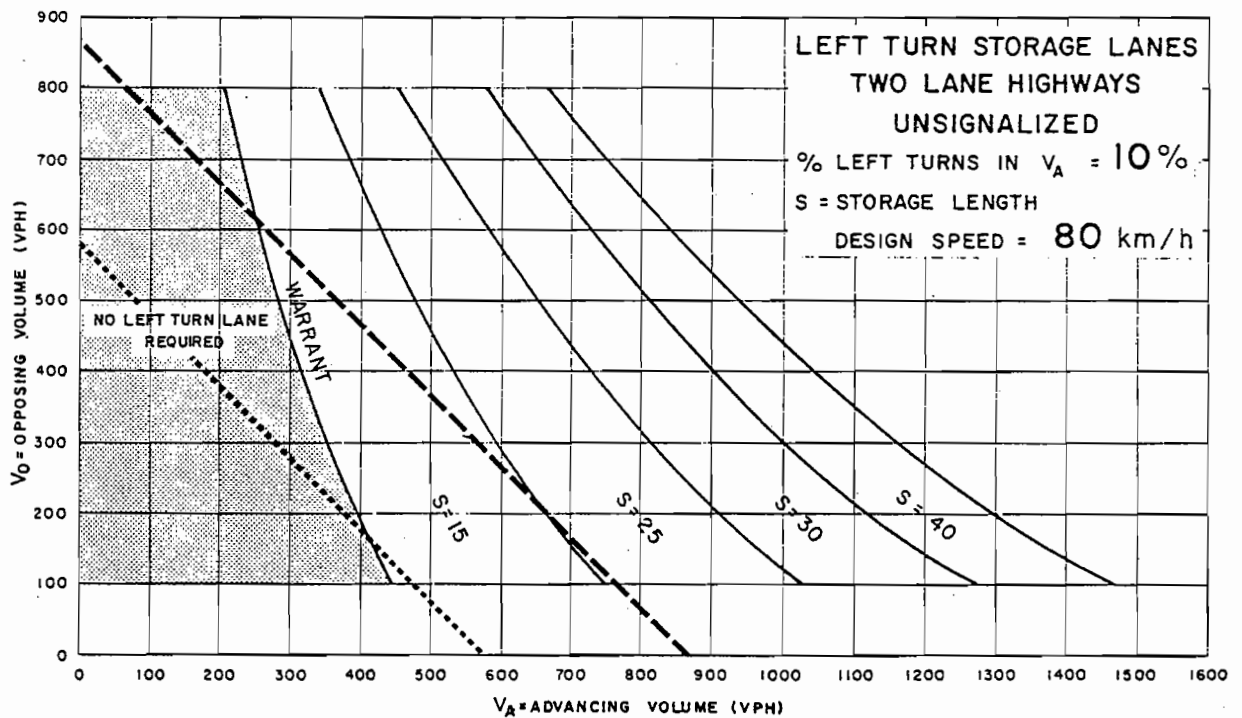
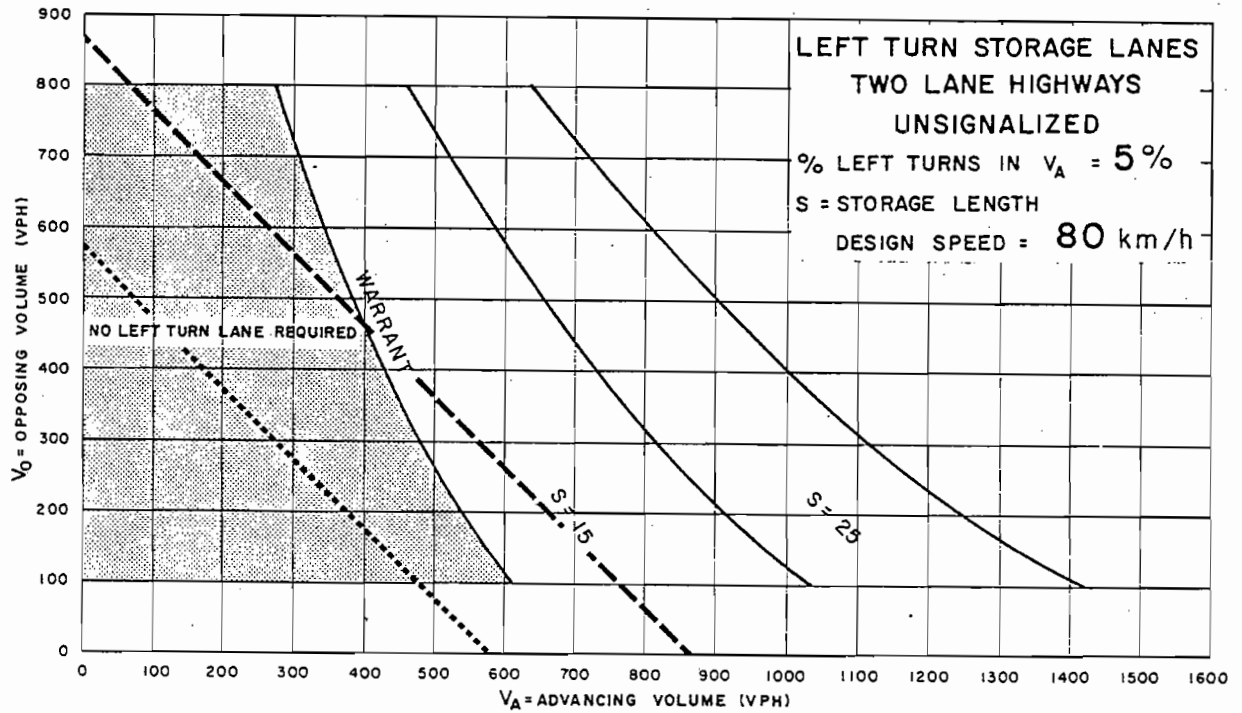

Figure EA-14

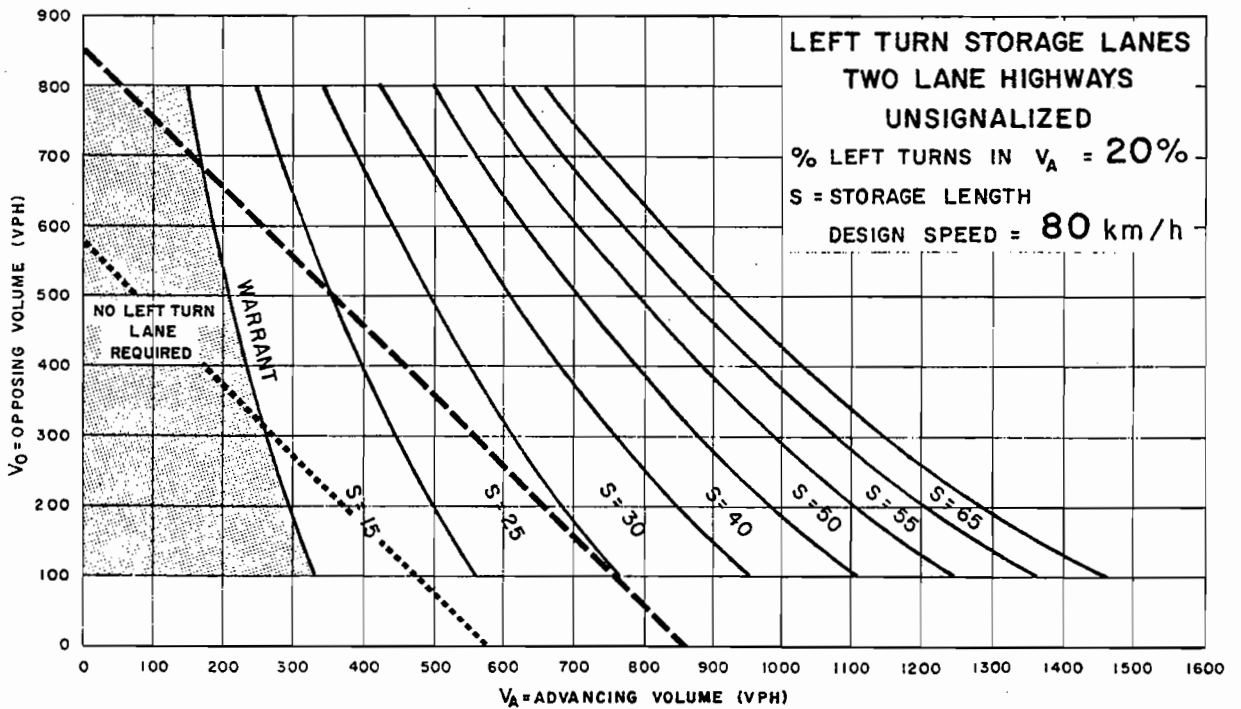
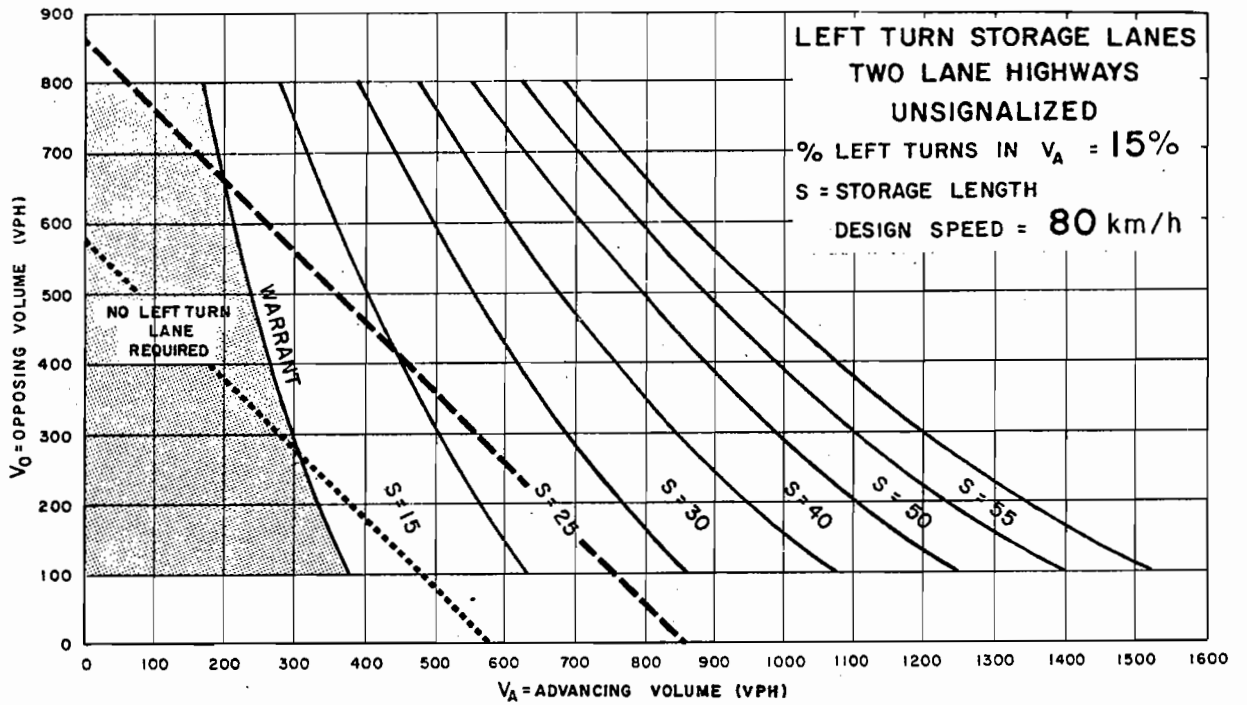
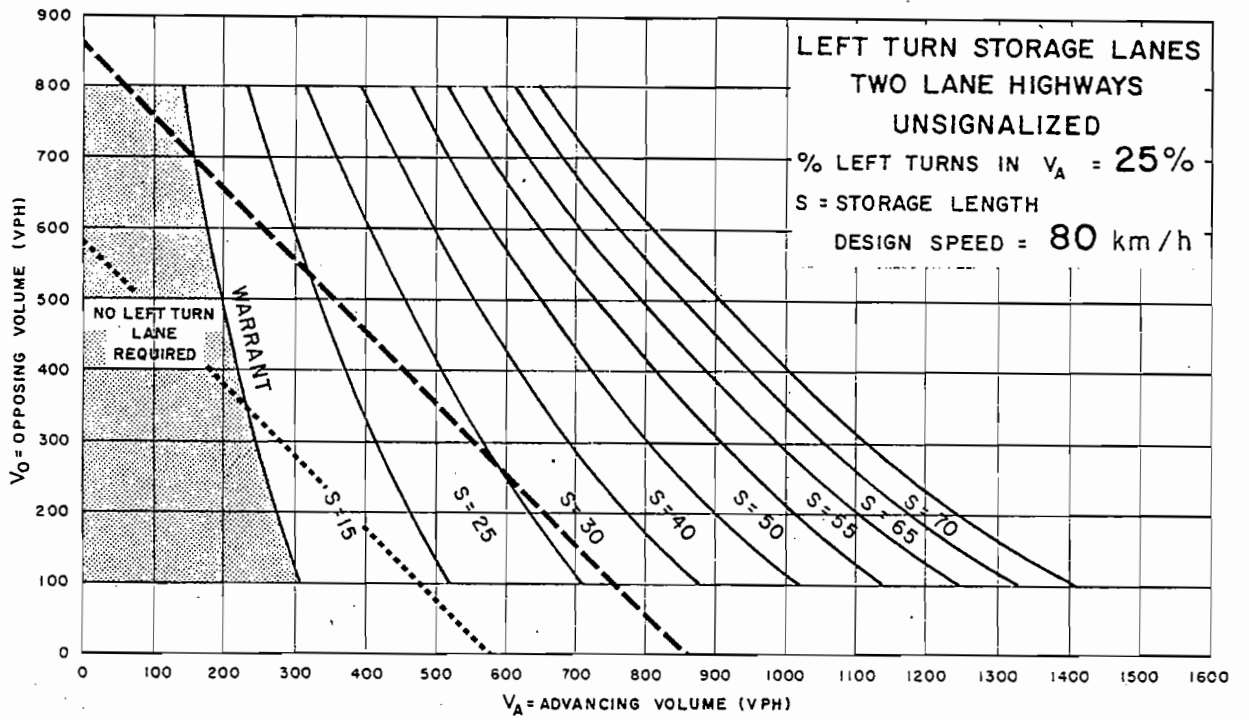

Figure EA-15



--- TRAFFIC SIGNALS MAY BE WARRANTED IN RURAL AREAS OR URBAN AREAS WITH RESTRICTED FLOW

..... TRAFFIC SIGNALS MAY BE WARRANTED IN "FREE FLOW" URBAN AREAS

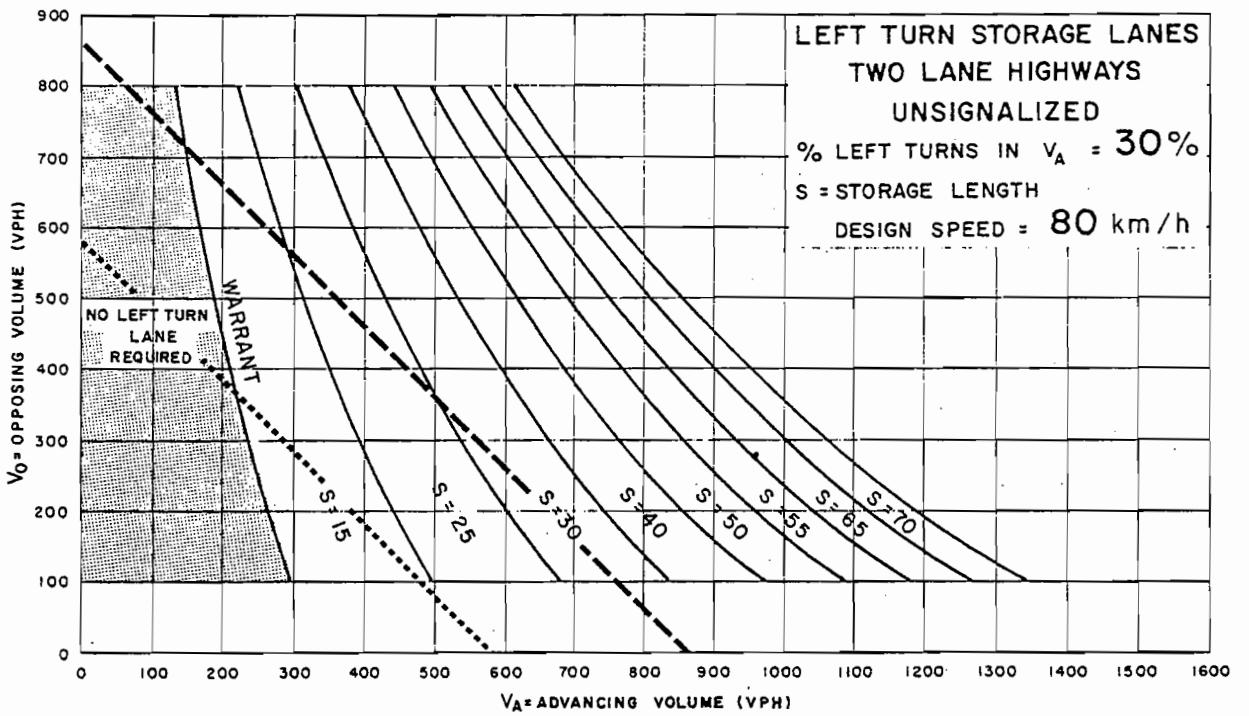

Figure EA-16

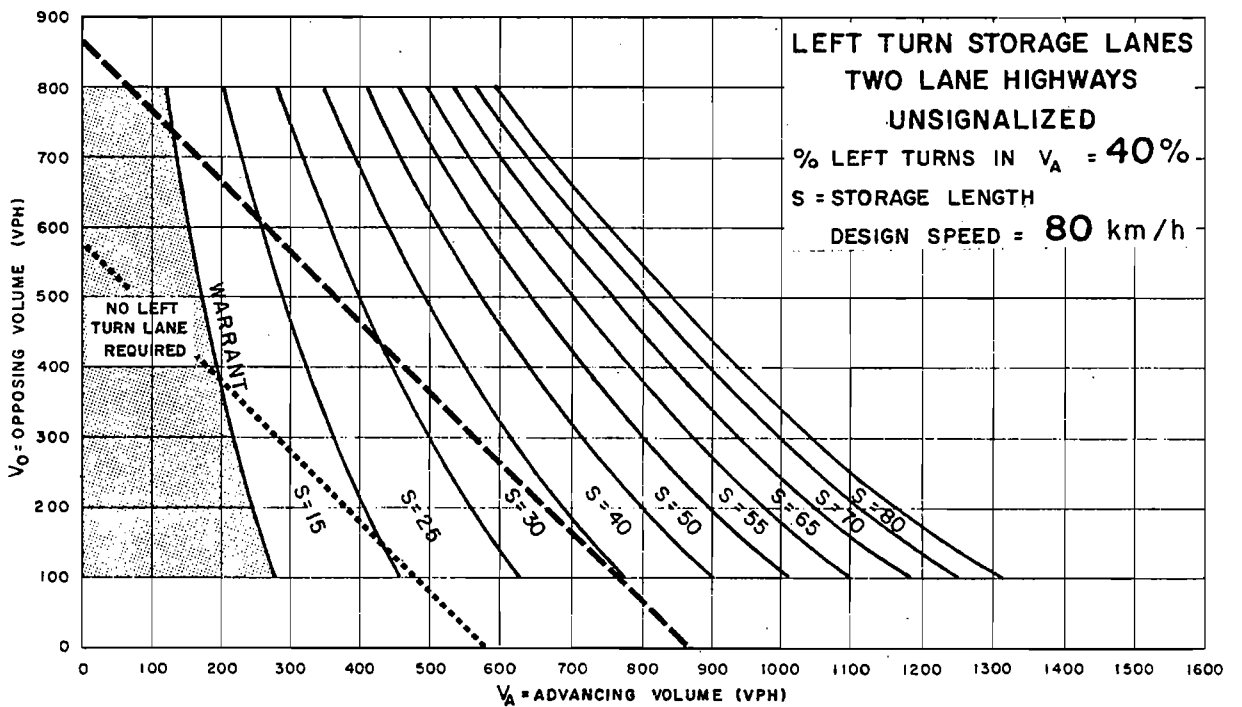
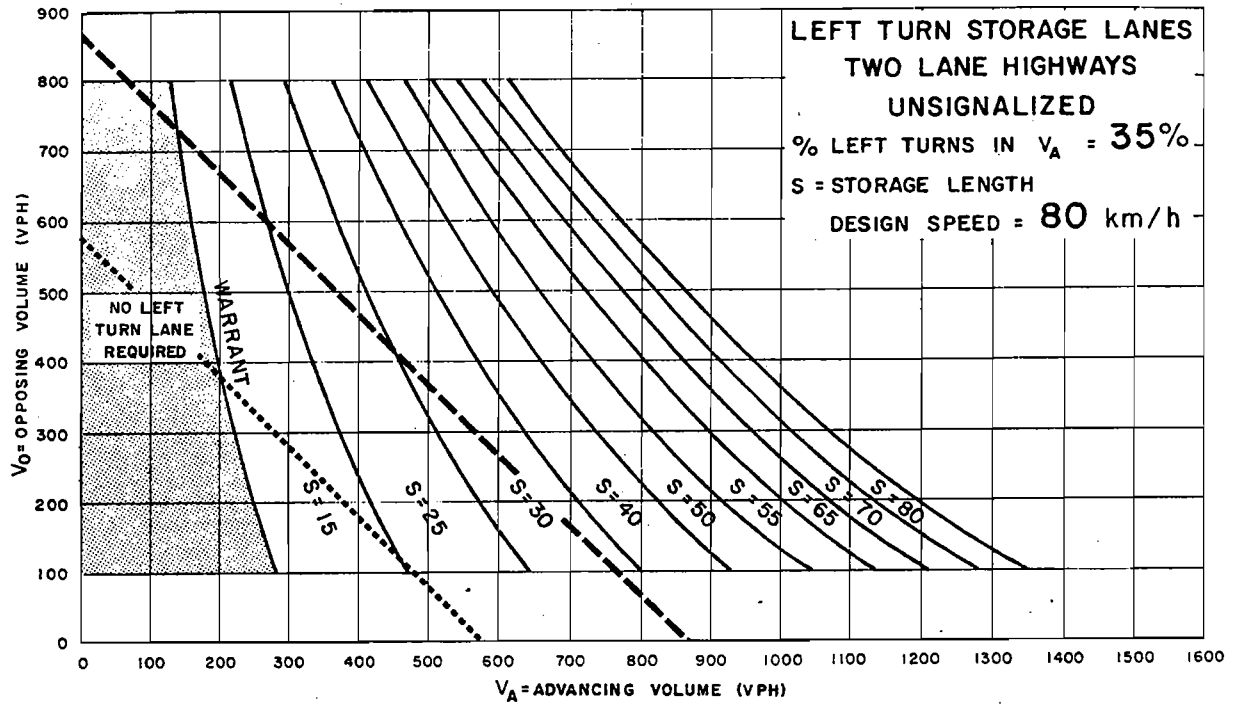
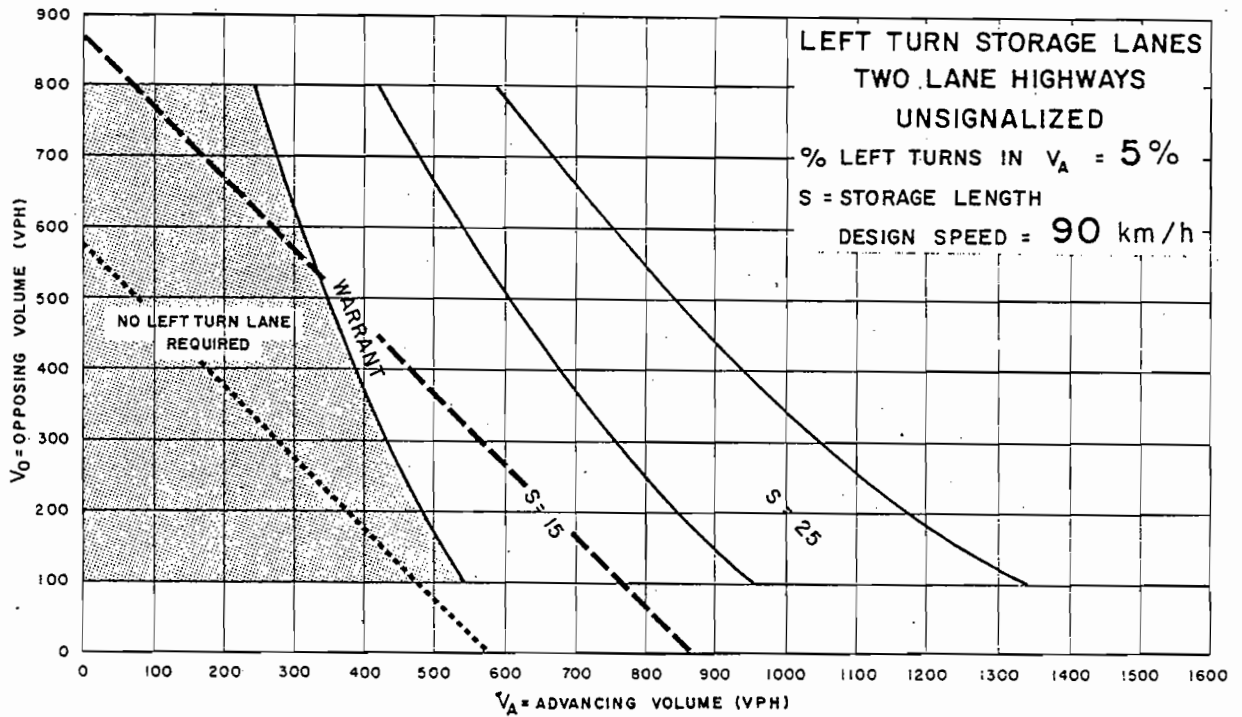

Figure EA-17



----- TRAFFIC SIGNALS MAY BE WARRANTED IN RURAL AREAS OR URBAN AREAS WITH RESTRICTED FLOW

..... TRAFFIC SIGNALS MAY BE WARRANTED IN "FREE FLOW" URBAN AREAS

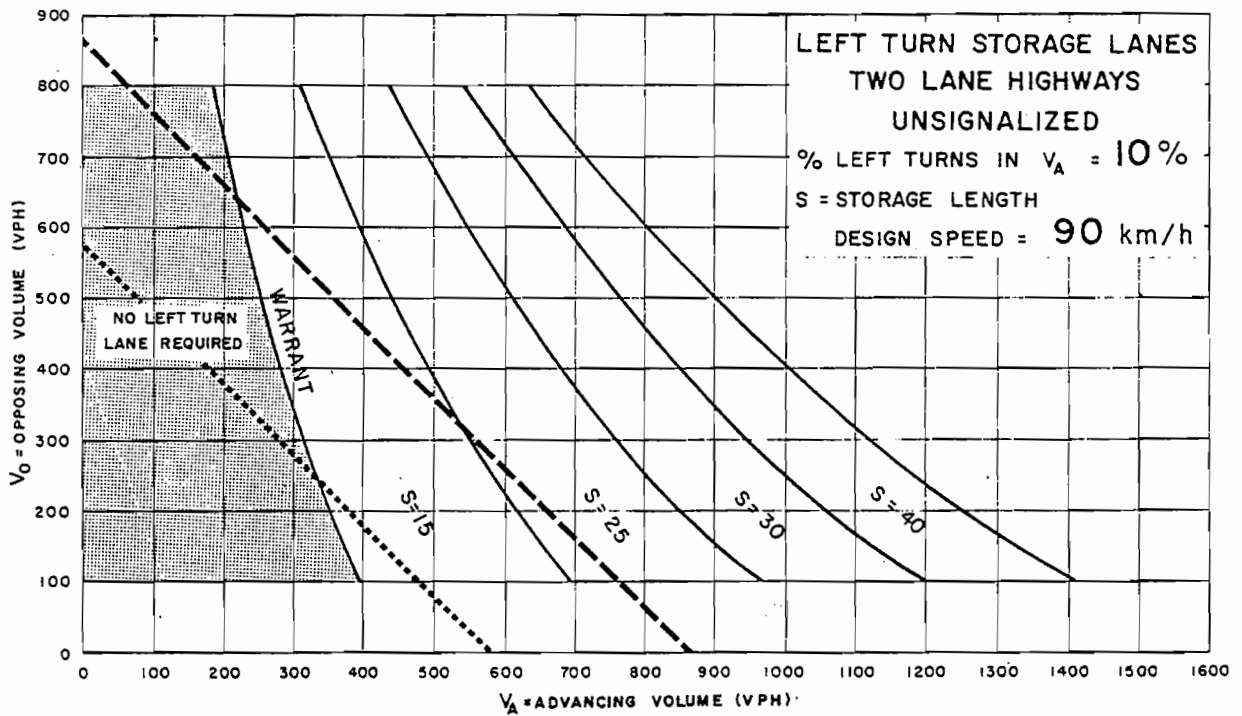

Figure EA-18

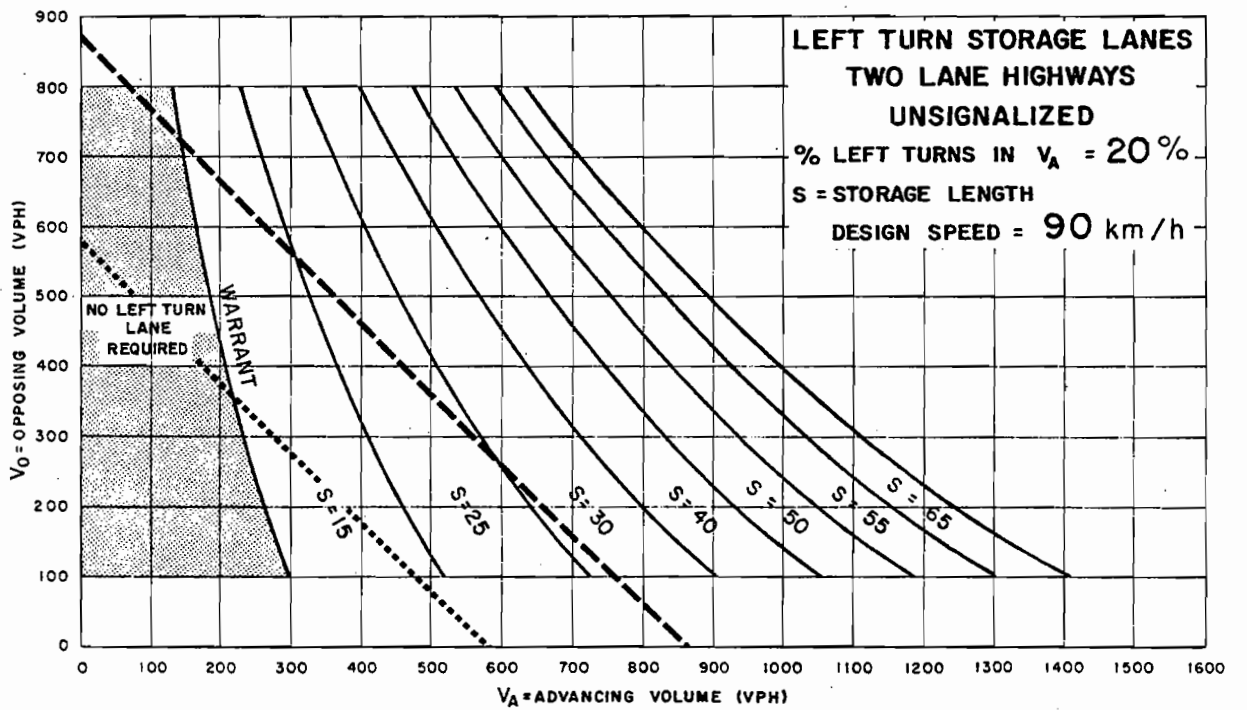
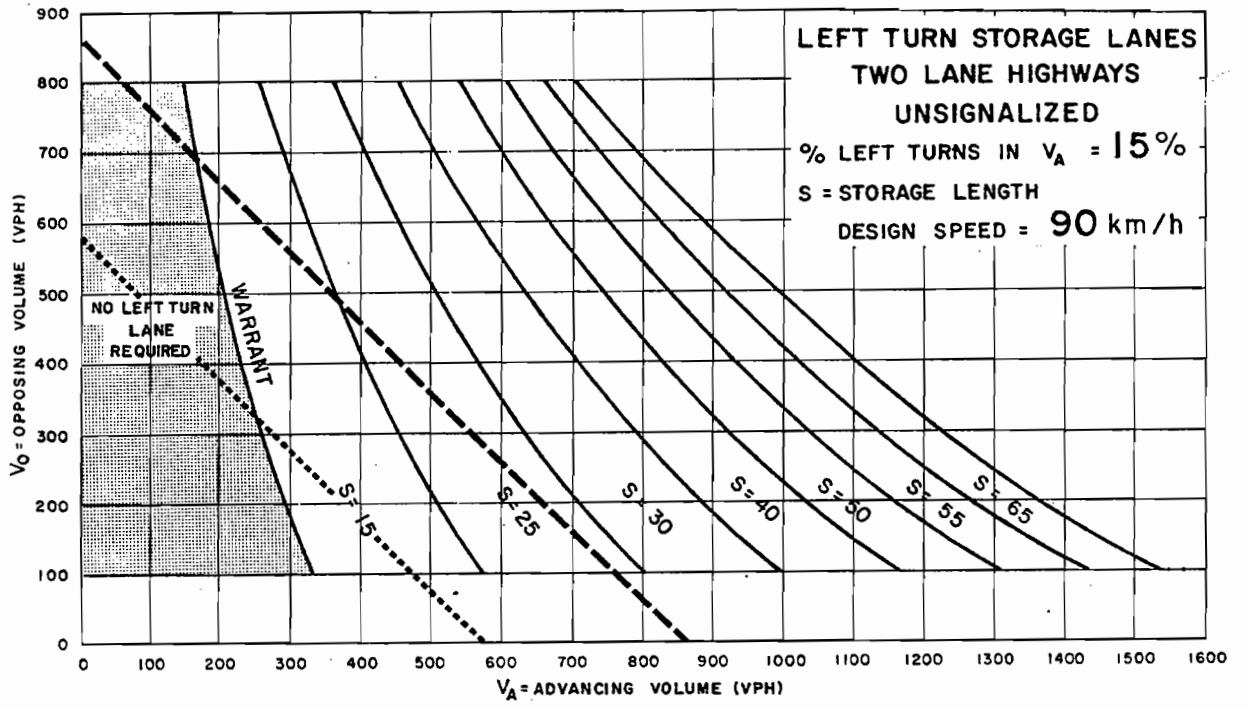
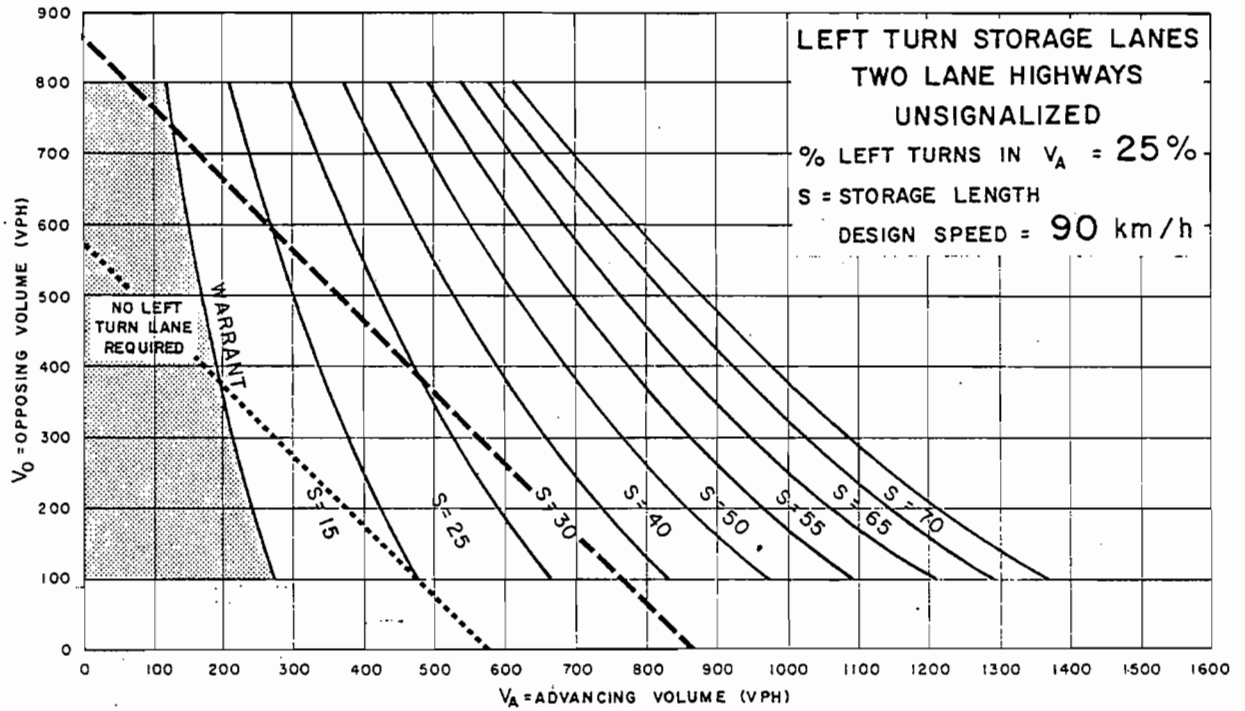

Figure EA-19



--- TRAFFIC SIGNALS MAY BE WARRANTED IN RURAL AREAS OR URBAN AREAS WITH RESTRICTED FLOW

..... TRAFFIC SIGNALS MAY BE WARRANTED IN "FREE FLOW" URBAN AREAS

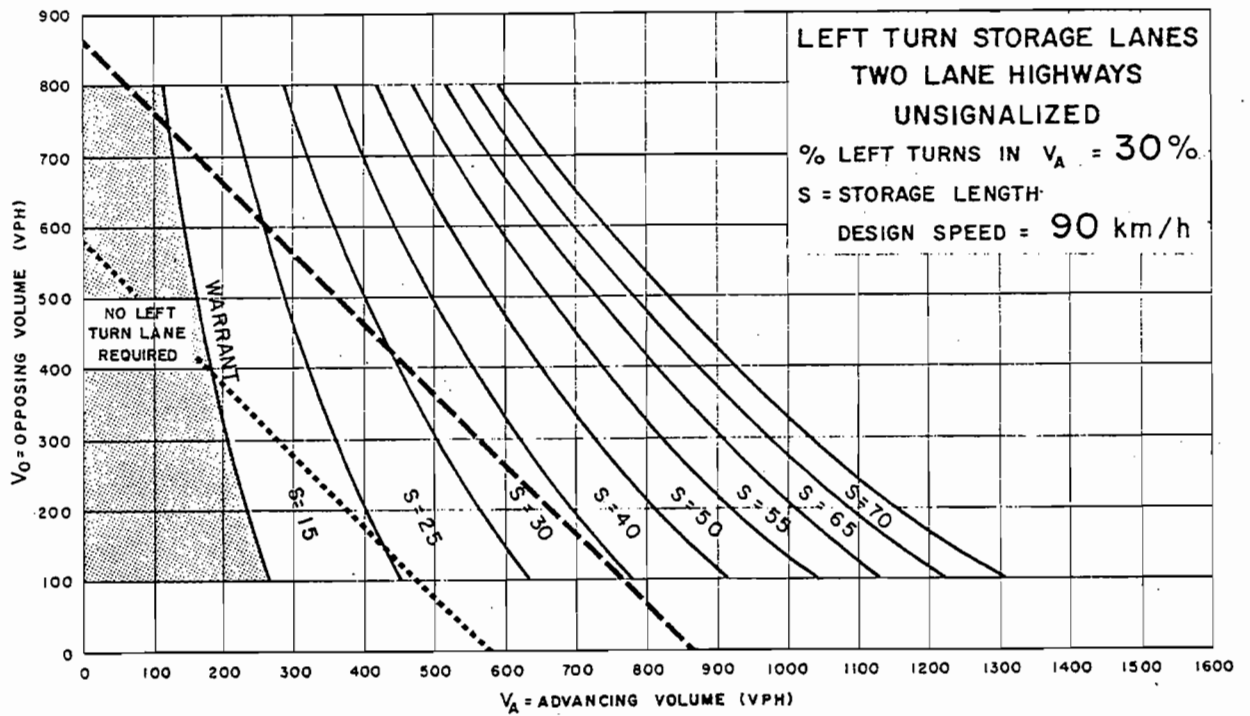
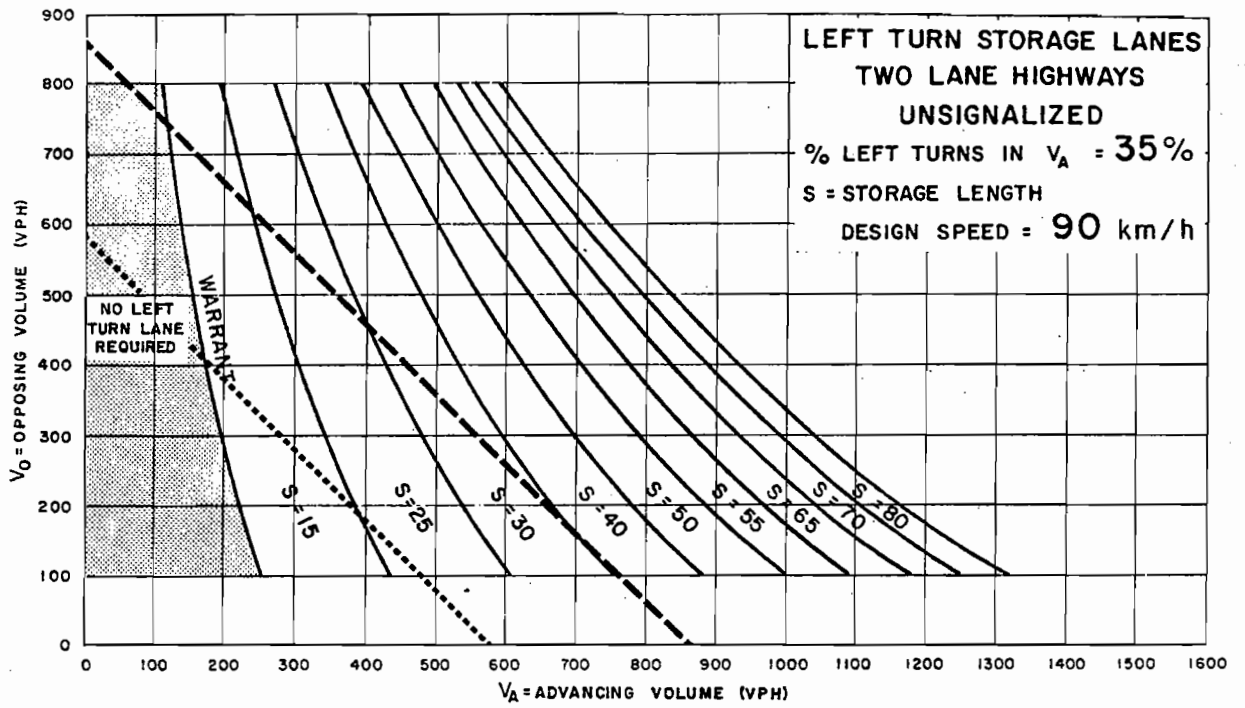

Figure EA-20



--- TRAFFIC SIGNALS MAY BE WARRANTED IN RURAL AREAS OR URBAN AREAS WITH RESTRICTED FLOW

..... TRAFFIC SIGNALS MAY BE WARRANTED IN "FREE FLOW" URBAN AREAS

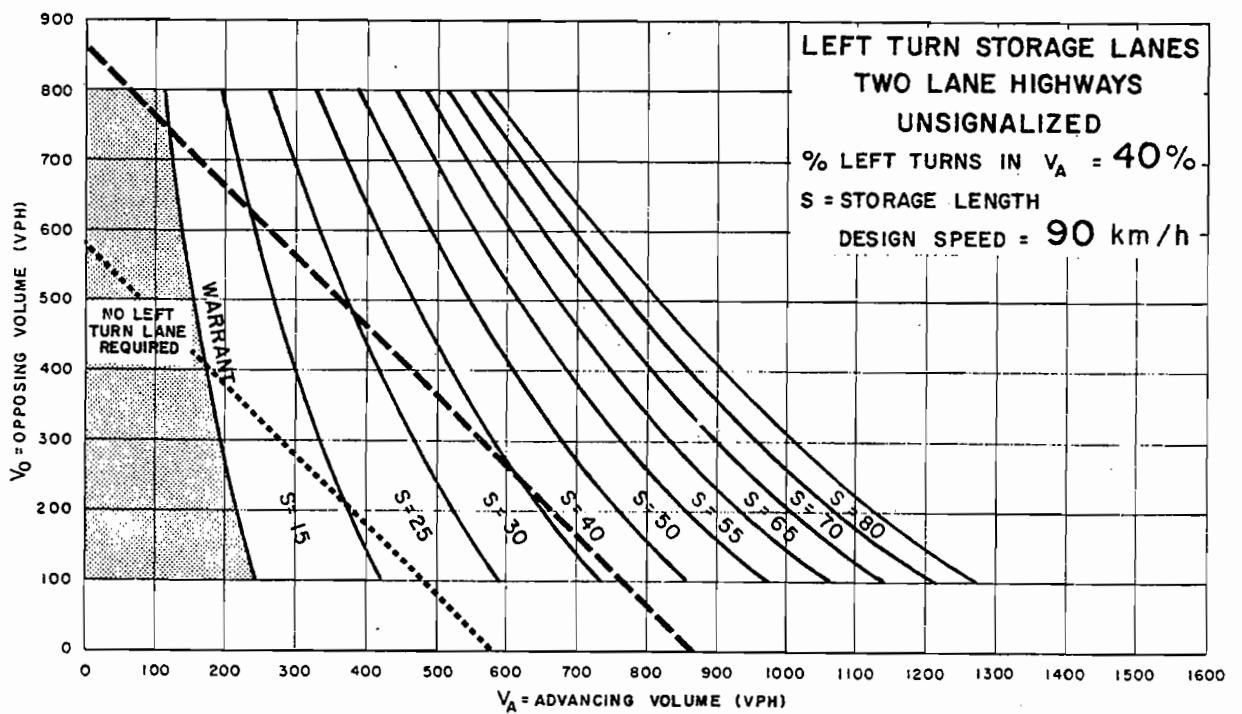
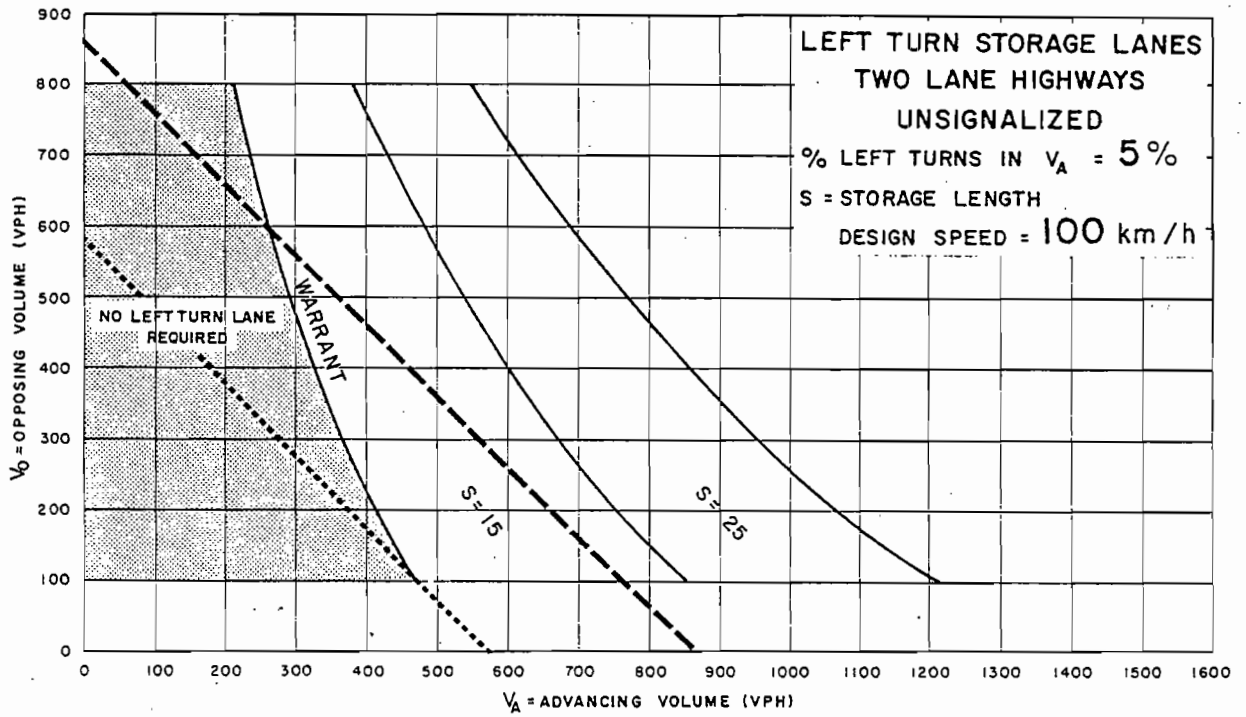

Figure EA-21



--- TRAFFIC SIGNALS MAY BE WARRANTED IN RURAL AREAS OR URBAN AREAS WITH RESTRICTED FLOW

..... TRAFFIC SIGNALS MAY BE WARRANTED IN "FREE FLOW" URBAN AREAS

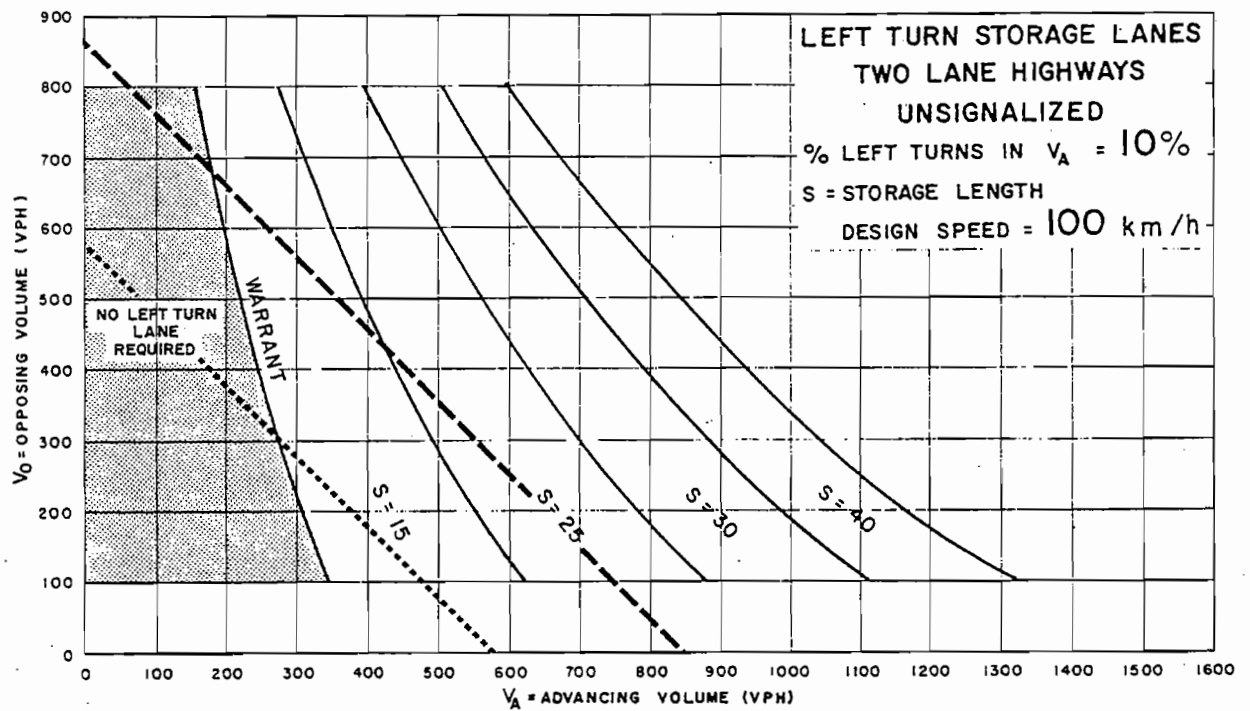
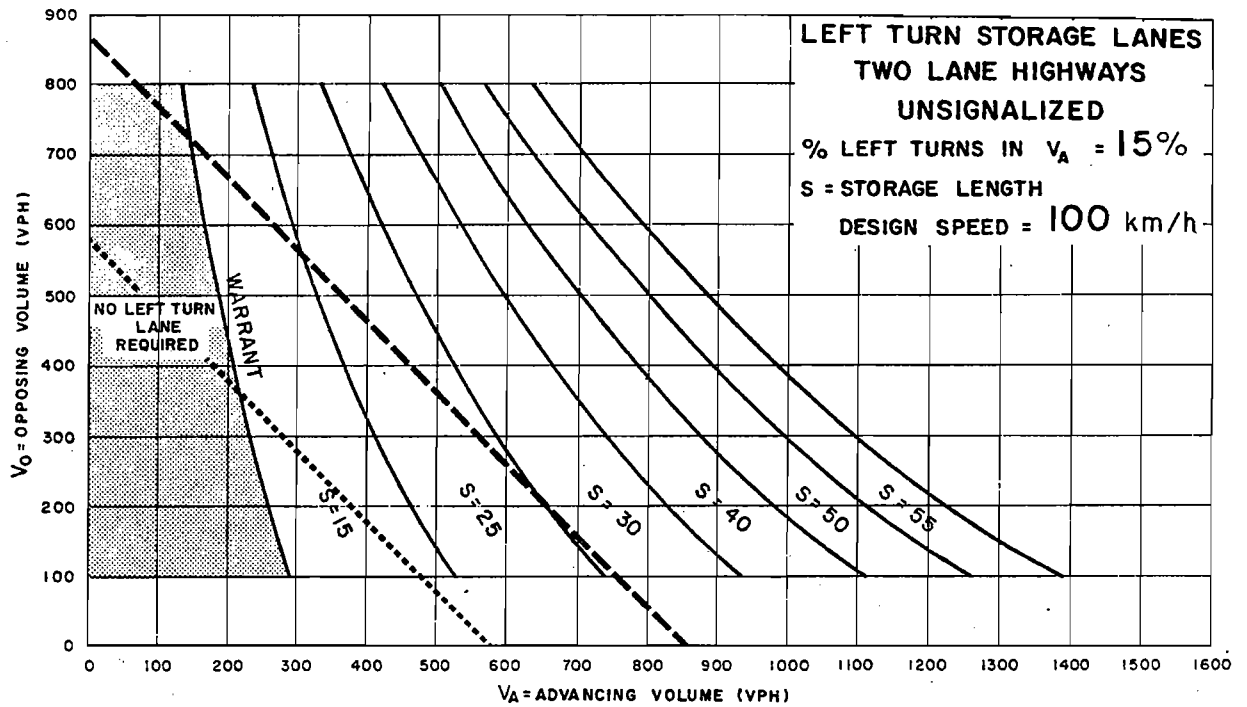

Figure EA-22



----- TRAFFIC SIGNALS MAY BE WARRANTED IN RURAL AREAS OR URBAN AREAS WITH RESTRICTED FLOW

..... TRAFFIC SIGNALS MAY BE WARRANTED IN "FREE FLOW" URBAN AREAS

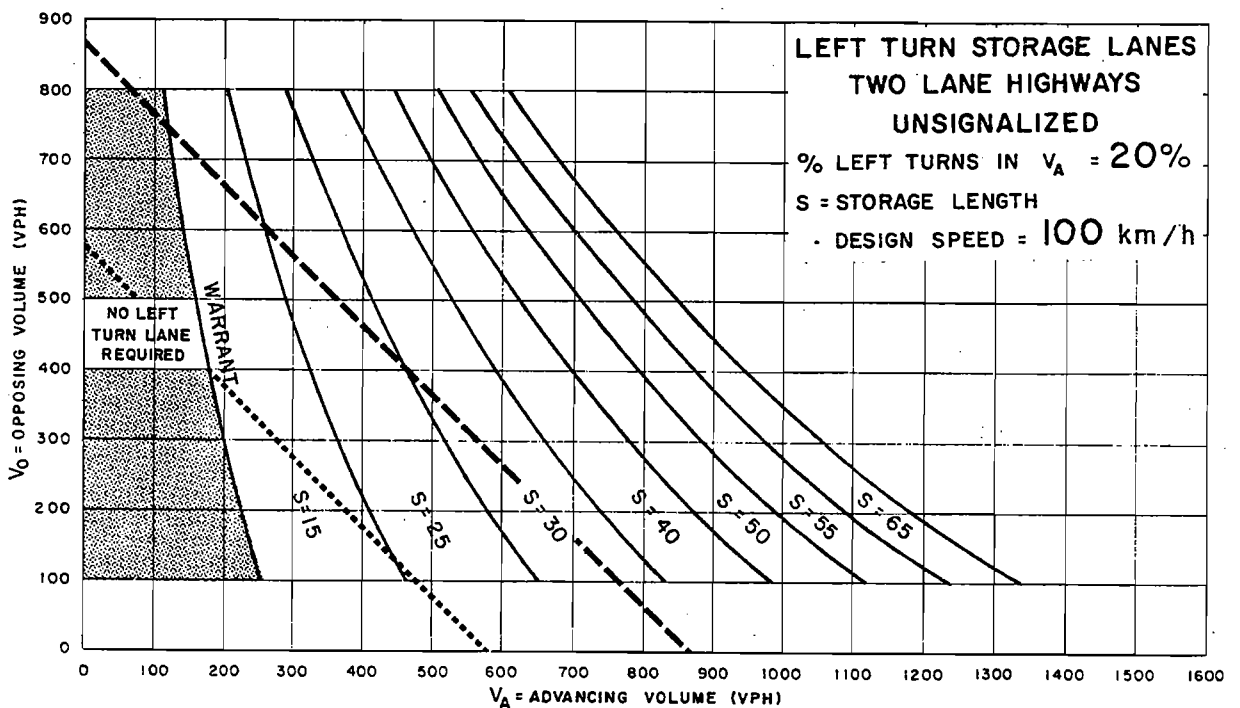

Figure EA-23

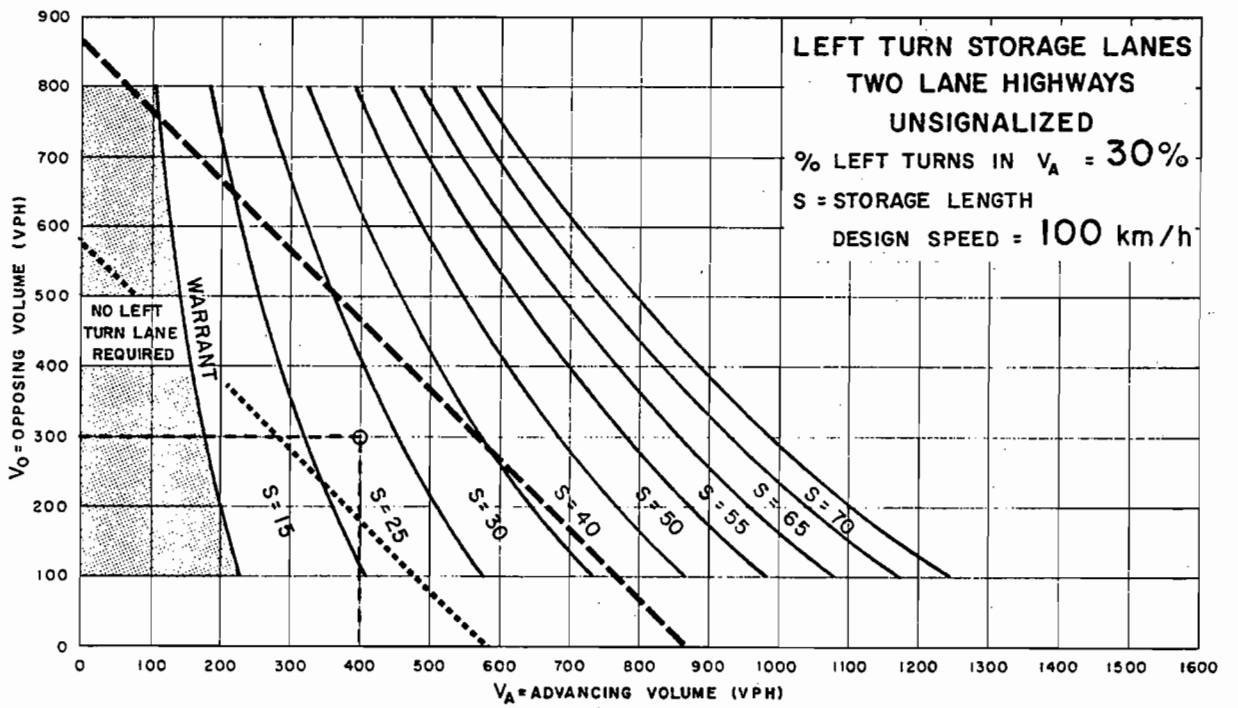
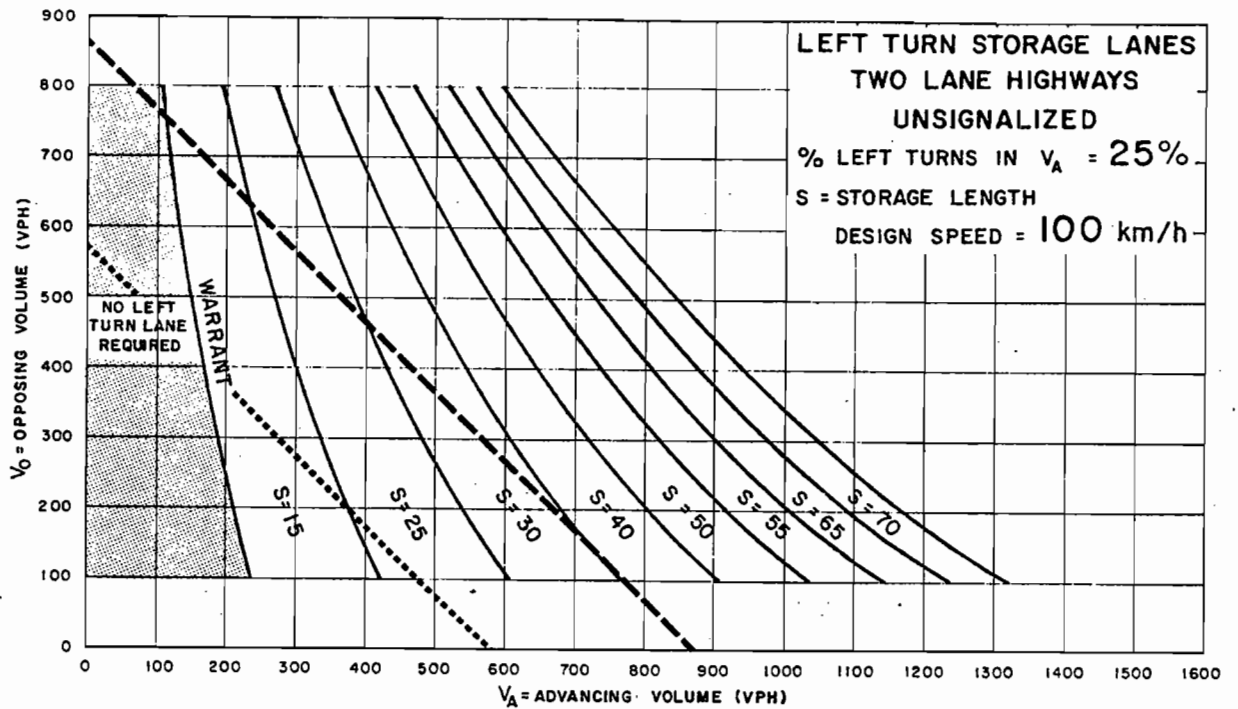

Figure EA-24

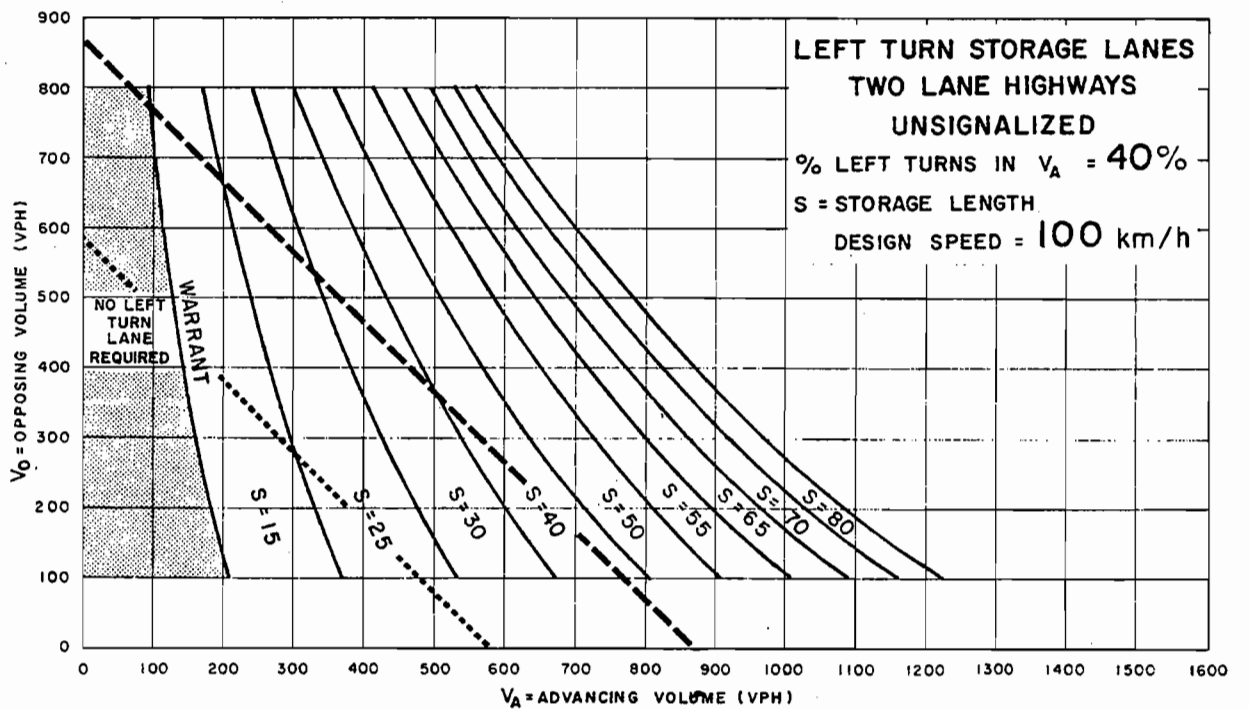
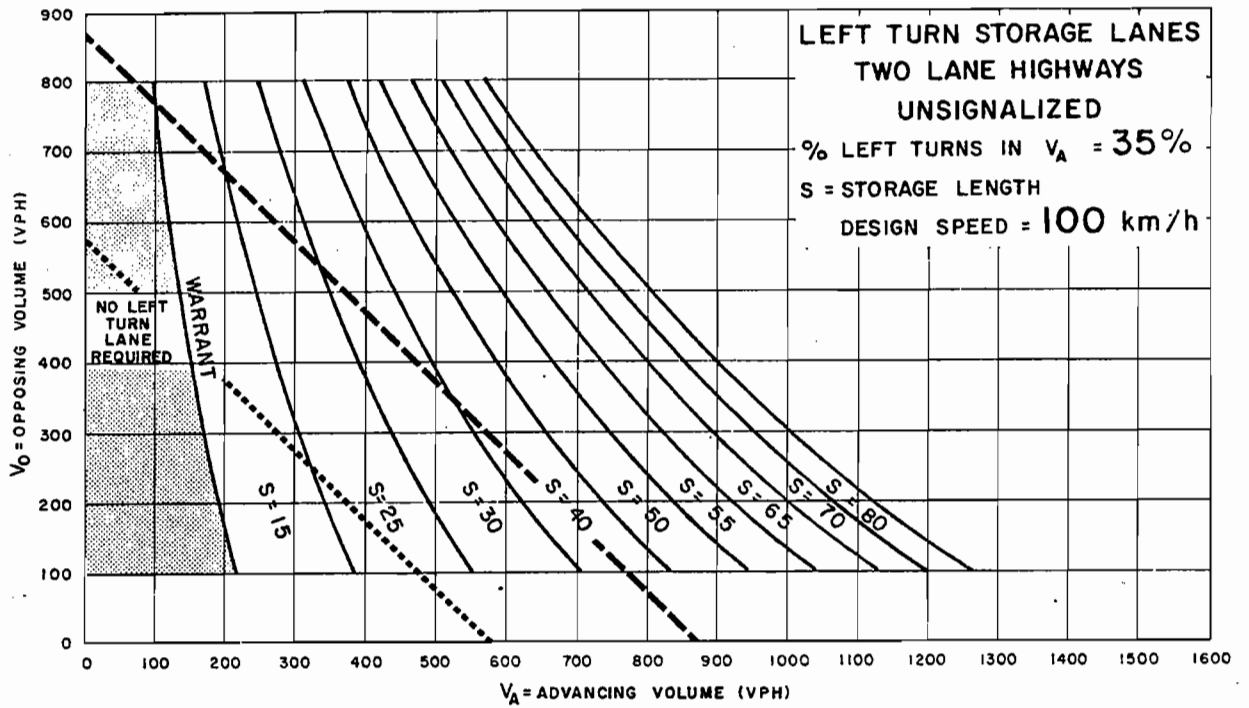
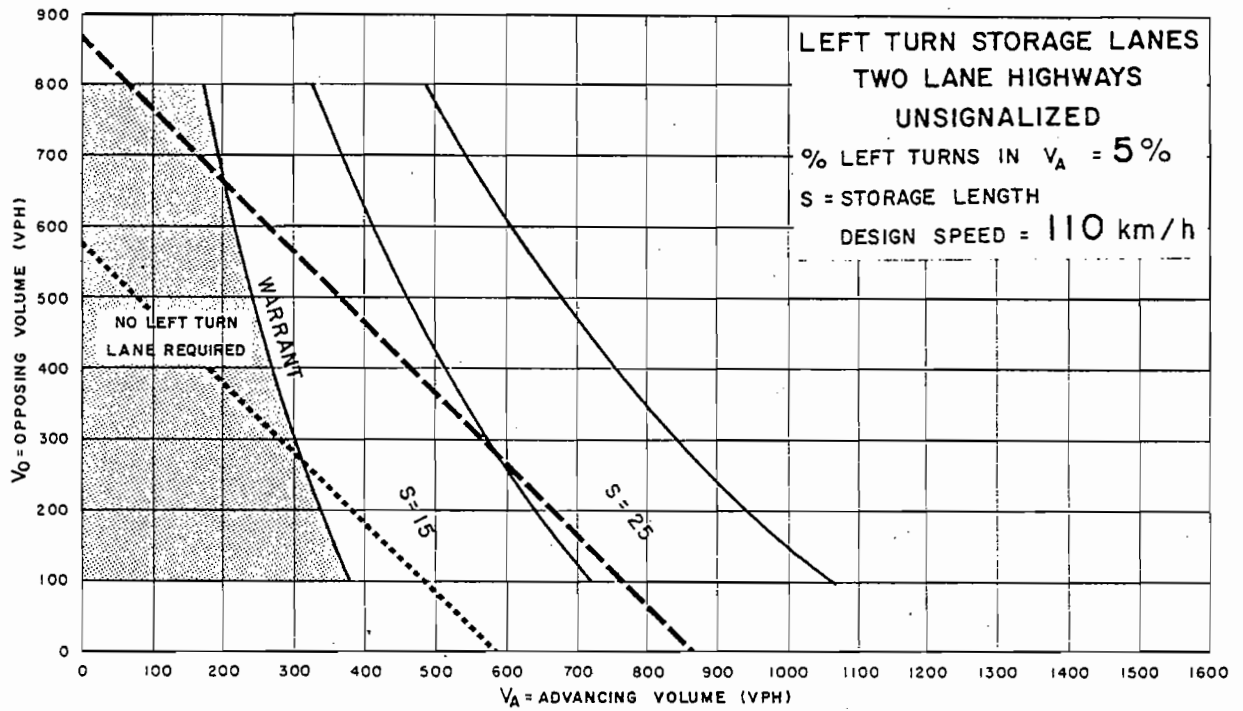

Figure EA-25



- - - - - TRAFFIC SIGNALS MAY BE WARRANTED IN RURAL AREAS OR URBAN AREAS WITH RESTRICTED FLOW
 TRAFFIC SIGNALS MAY BE WARRANTED IN "FREE FLOW" URBAN AREAS

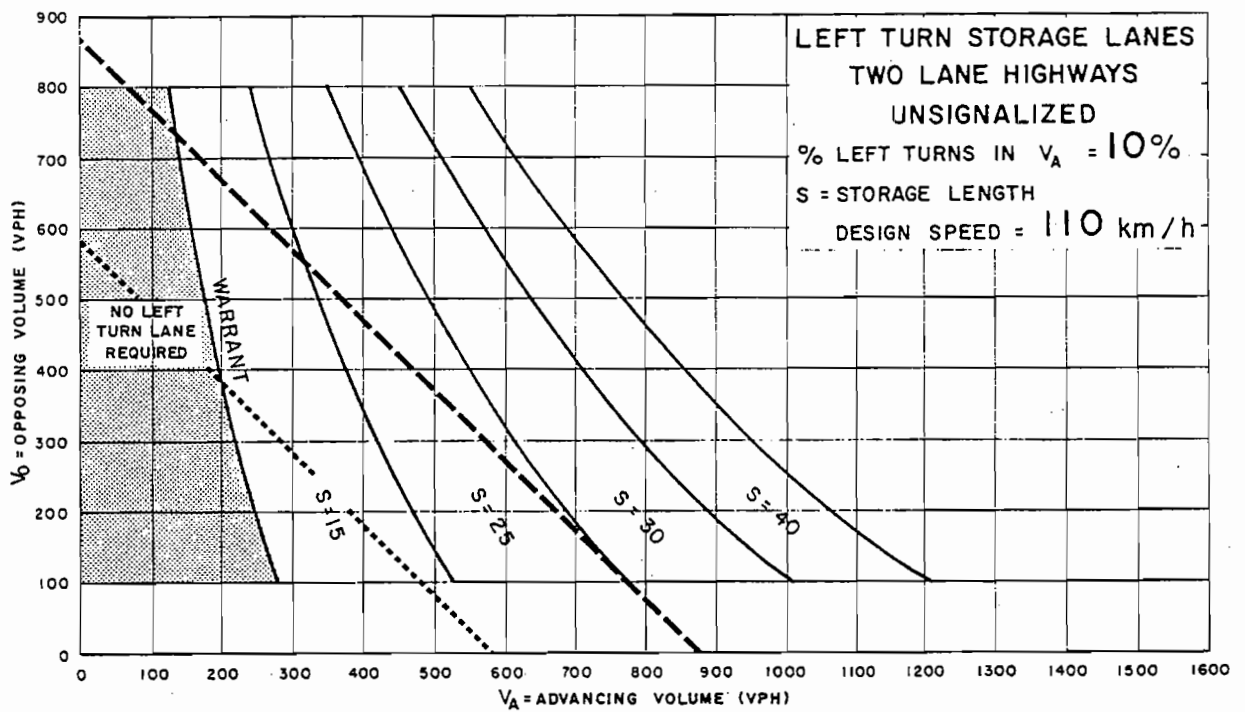

Figure EA-26

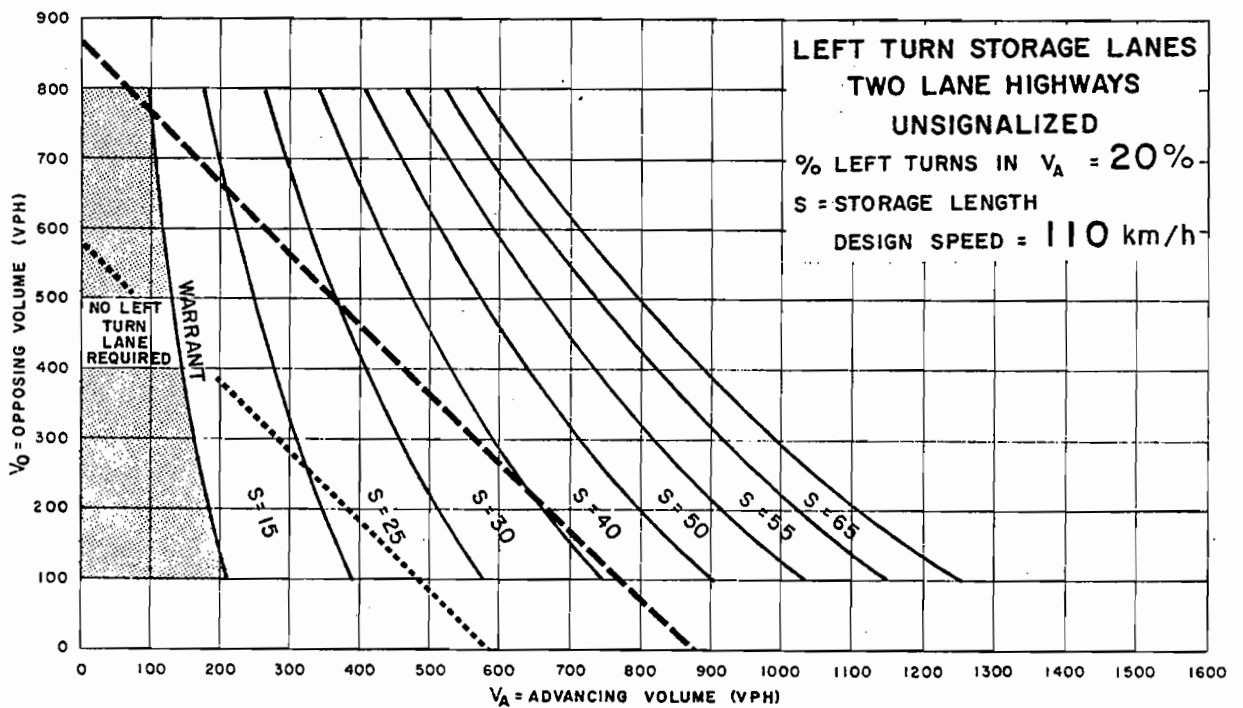
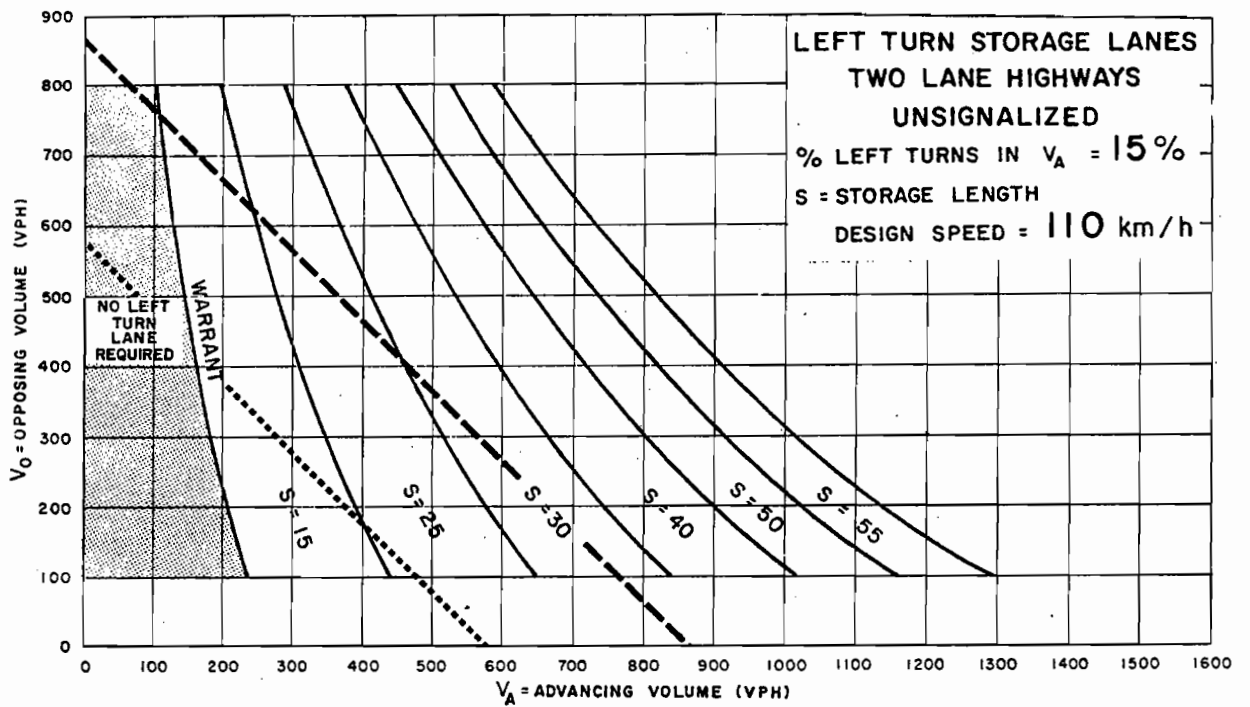
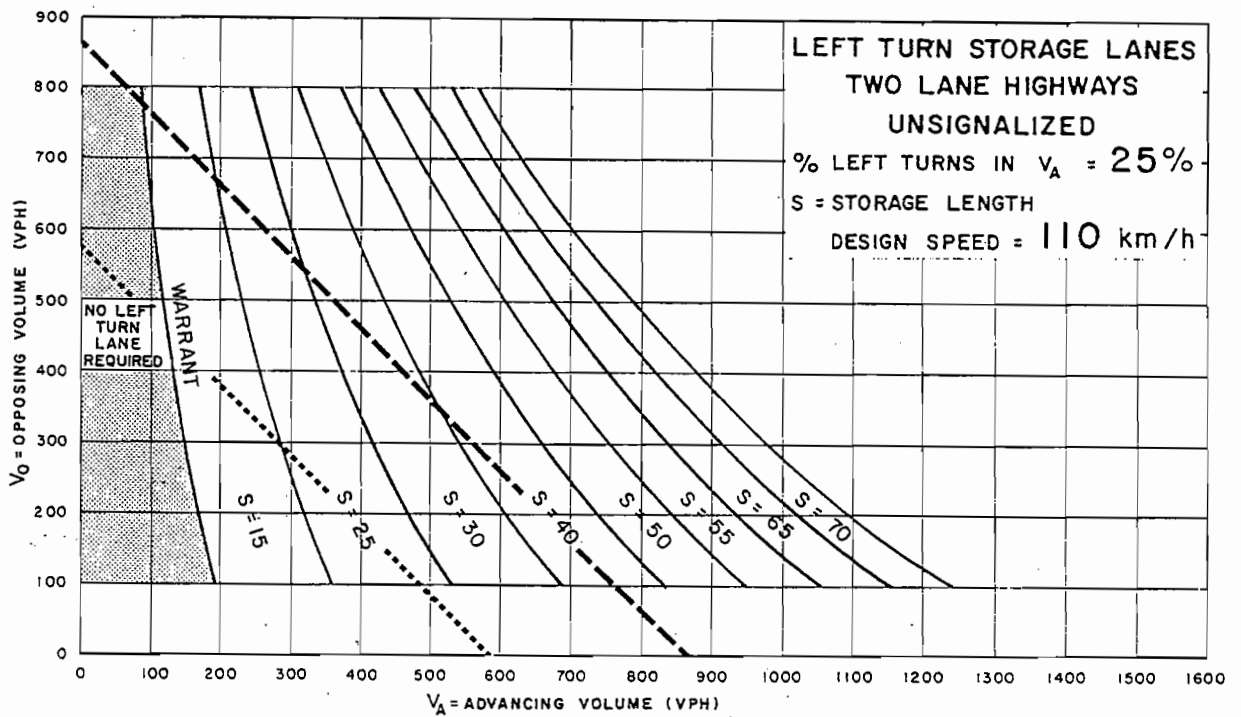

Figure EA-27



--- TRAFFIC SIGNALS MAY BE WARRANTED IN RURAL AREAS OR URBAN AREAS WITH RESTRICTED FLOW

..... TRAFFIC SIGNALS MAY BE WARRANTED IN "FREE FLOW" URBAN AREAS

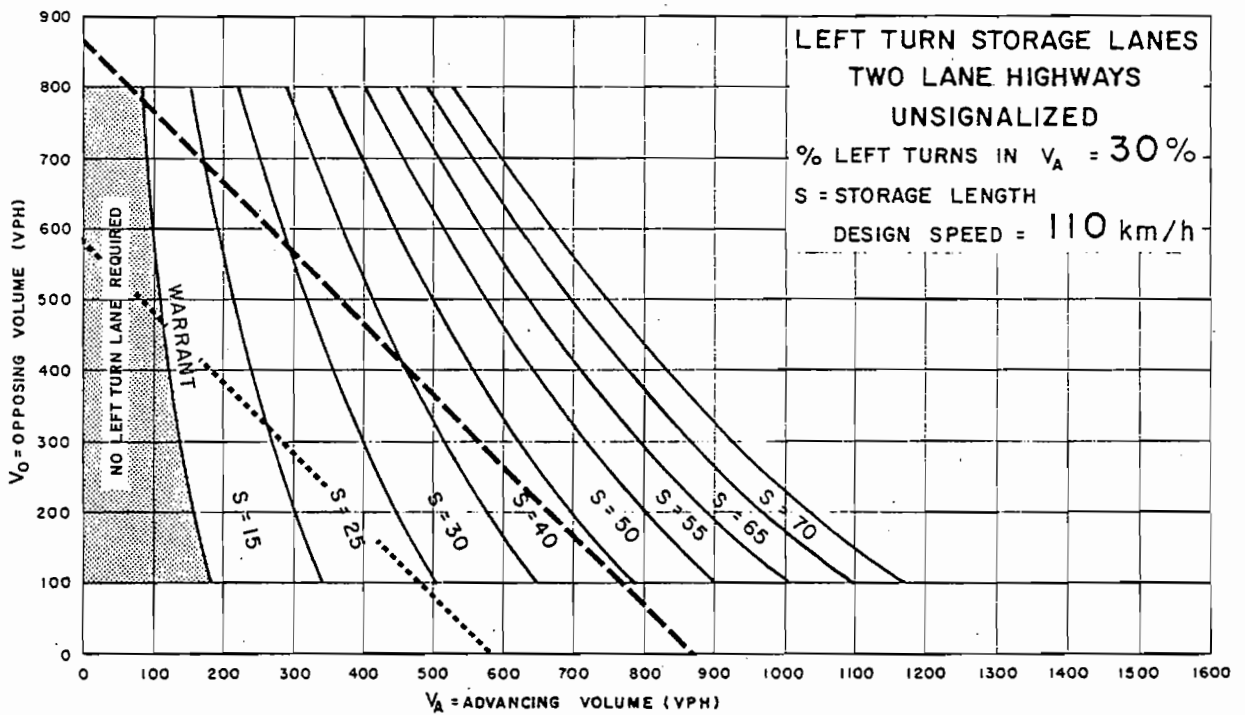
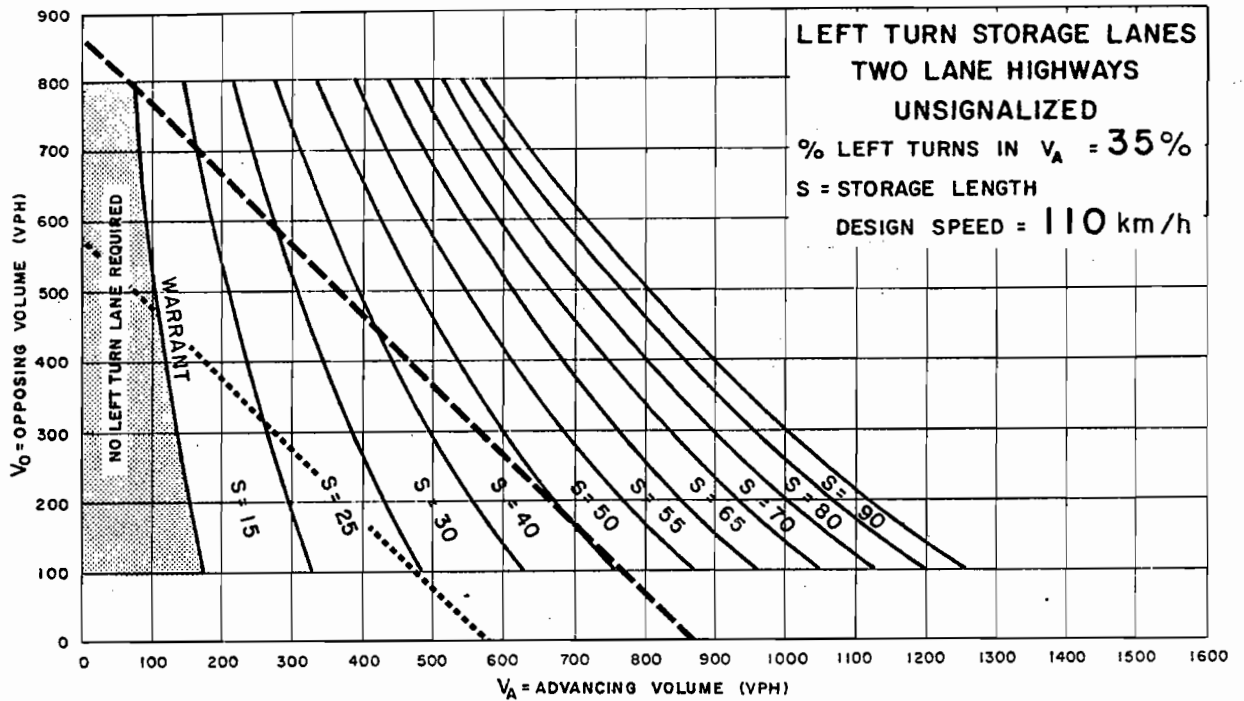

Figure EA-28



--- TRAFFIC SIGNALS MAY BE WARRANTED IN RURAL
AREAS OR URBAN AREAS WITH RESTRICTED FLOW

..... TRAFFIC SIGNALS MAY BE WARRANTED IN
"FREE FLOW" URBAN AREAS

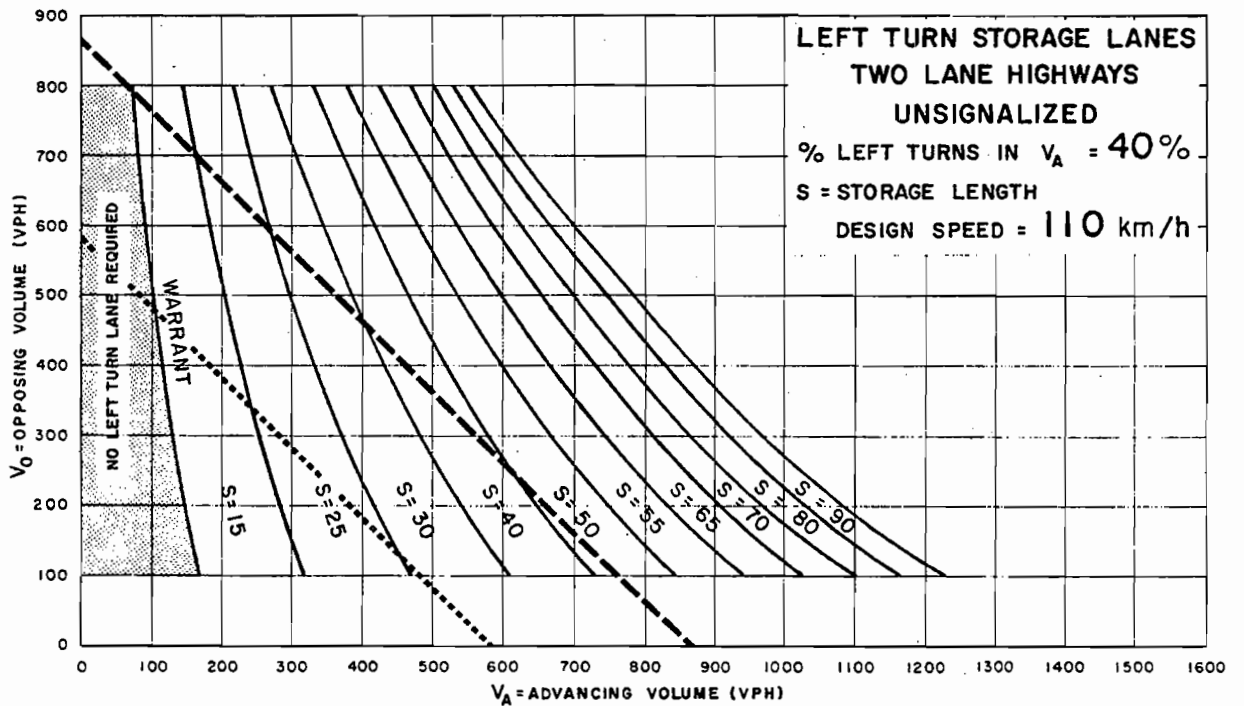

Figure EA-29

**E.B.1 LEFT TURN LANE WARRANTS AND STORAGE
LANE LENGTHS FOR FOUR-LANE UNDIVIDED
HIGHWAYS; UNSIGNALIZED INTERSECTIONS**USE OF GRAPH

1. Select the appropriate figure for left turning volumes from the bottom of the graph and extend a line upward.
2. Select the appropriate figure for the opposing volumes from the left hand side of the graph and extend a line across.
3. Locate the point of intersection of the extended lines. If the point falls to the left of the warrant line, a left turn lane is not warranted.
4. If the point falls to the right of the warrant line, a left turn lane is warranted and its storage length is indicated

by the value of 'S' shown on the graph.

An example of applying the graph in Figure EB-1 is illustrated below:

Left turning Volume $V_L = 100$ vph
Opposing Volume $V_O = 400$ vph

Projected line from these values intersect to the right of the warrant line and within the area marked 'S' - 15 m - a left turn lane is warranted and the storage length should be 15 m.

Note: All at-grade crossings on controlled access divided highways where left turns are permitted, shall have a minimum left turn lane consisting of the taper and parallel lane due to the high operating speeds. See Figure E10-10.

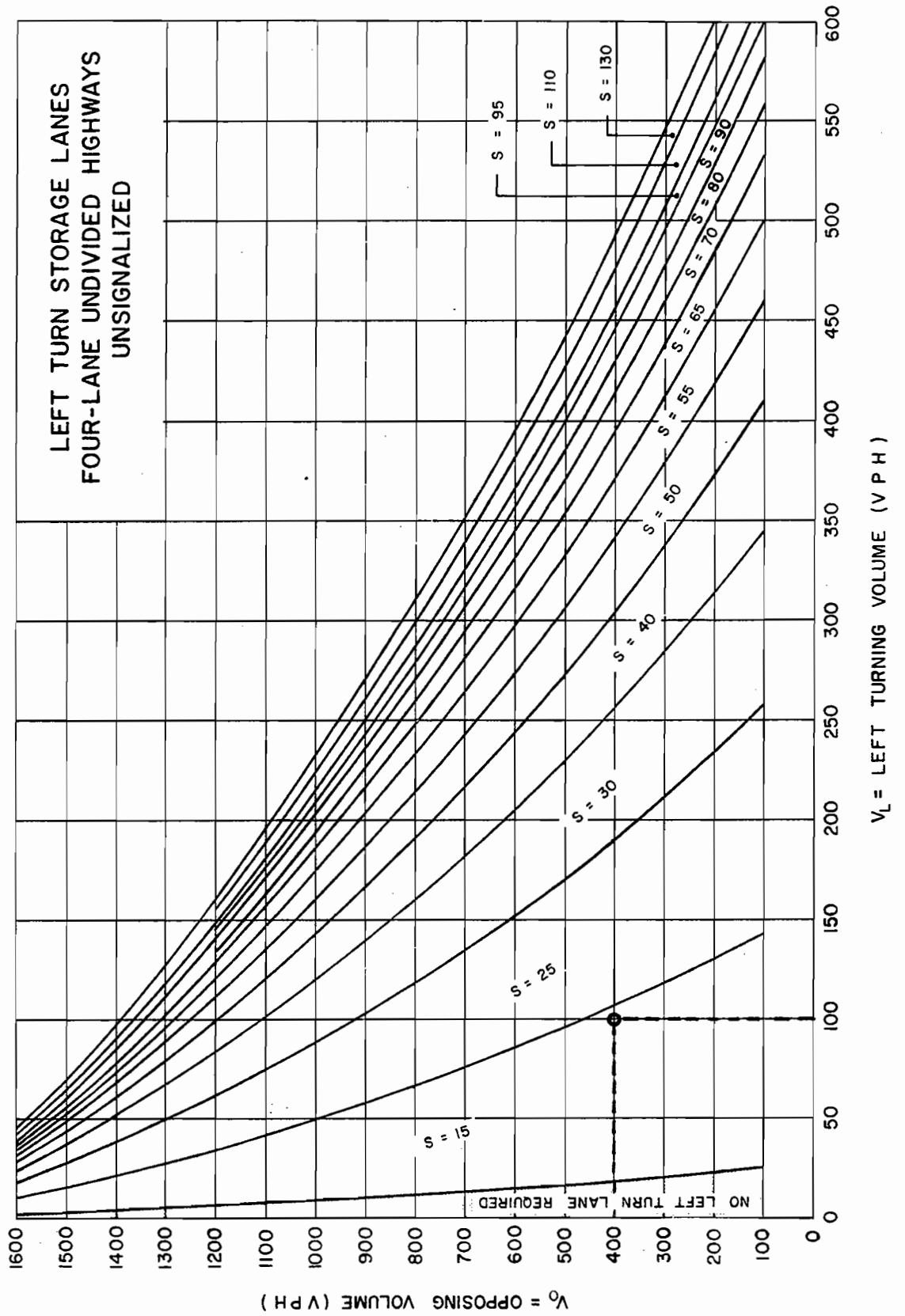

Figure EB-1

E.C.1 LEFT TURN LANE WARRANTS AND STORAGE LANE LENGTHS FOR FOUR-LANE DIVIDED HIGHWAYS; UNSIGNALIZED INTERSECTIONS

For Use of Graph, See Appendix B.

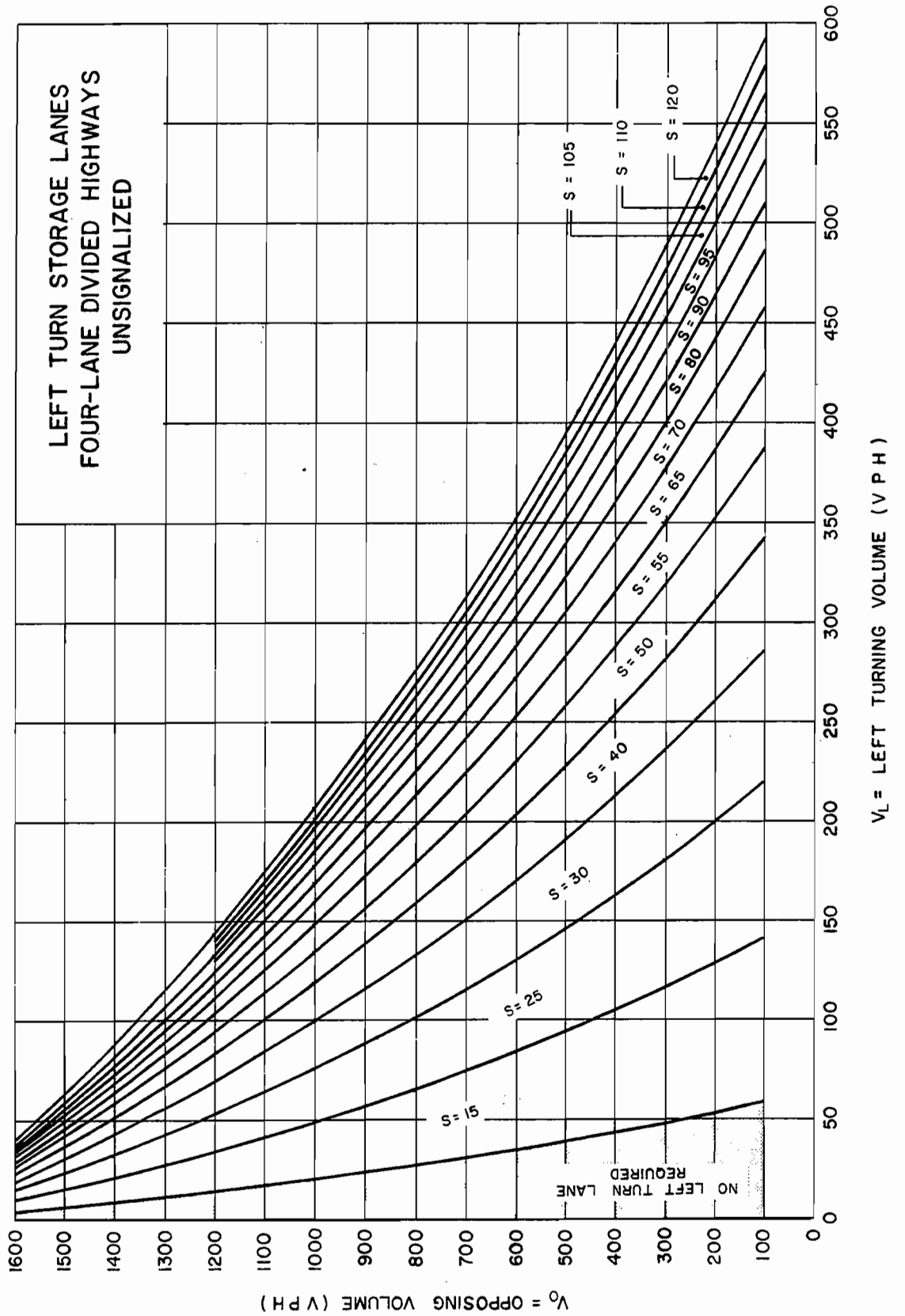

Figure EC-1

CHAPTER F

INTERCHANGES

CHAPTER F
INTERCHANGES
CONTENTS

F.1	INTRODUCTIONF1-1
F.1.1	GeneralF1-1
F.1.2	Design ConsiderationsF1-1
F.1.3	Design FeaturesF1-1
F.2	WARRANTSF2-1
F.2.1	GeneralF2-1
F.2.2	ClassificationF2-1
F.2.3	TrafficF2-1
F.2.4	SafetyF2-1
F.2.5	TopographyF2-1
F.2.6	User Benefits.F2-1
F.3	INTERCHANGE TYPESF3-1
F.3.1	GeneralF3-1
F.3.2	Interchanges Between FreewaysF3-1
F.3.3	Interchanges Between freeways and Other RoadsF3-3
F.3.4	Interchanges Between Roads Other than Freeways.F3-11
F.4	SYSTEMS CONSIDERATIONF4-1
F.4.1	GeneralF4-1
F.4.2	Interchange Location and SpacingF4-1
F.4.3	Coordination of InterchangesF4-1
F.4.4	Lane Balance and Basic LanesF4-2
F.4.4.1	Lane BalanceF4-2
F.4.4.2	Basic Lanes.F4-7
F.4.4.3	Coordination of Lane Balance and Basic LanesF4-7
F.4.5	WeavingF4-7
F.4.6	Lane and Route continuityF4-11
F.4.7	Freeway/Service Road SystemsF4-15
F.4.8	Express/Collector systems.F4-15
F.5	INTERCHANGE RAMPS.F5-1
F.5.1	GeneralF5-1
F.5.2	Design Considerations.F5-2
F.5.2.1	Ramp GeometryF5-2
F.5.2.2	Design SpeedF5-2
F.5.2.3	Sight DistanceF5-2

CHAPTER F
INTERCHANGES
CONTENTS

F.5.3	Exit TerminalsF5-3
	F.5.3.1 Single-Lane ExitsF5-3
	F.5.3.2 Two-Lane ExitsF5-5
	F.5.3.3 Three-Lane ExitsF5-6
	F.5.3.4 Major ForkF5-6
	F.5.3.5 Exit Terminal BullnosesF5-7
	F.5.3.6 Sight Distance at Exit Terminals.F5-8
	F.5.3.7 Design Lengths for Exit Terminal Speed-Change LanesF5-9
F.5.4	Entrance Terminals.	F5-14
	F.5.4.1 Single-Lane Entrances	F5-14
	F.5.4.2 Two-Lane Entrances	F5-15
	F.5.4.3 Three-Lane Entrances	F5-16
	F.5.4.4 Entrance Terminal Bullnoses	F5-17
	F.5.4.5 Sight Distance at Entrance Bullnose	F5-18
	F.5.4.6 Design Lengths for Entrance Terminal Speed-Change Lanes	F5-19
	F.5.4.7 Successive Entrance Ramps.	F5-23
F.5.5	Ramp Terminal Spacing	F5-24
F.5.6	Ramp Design	F5-24
F.5.7	Typical Designs	F5-26
F.6	COLLECTOR LANESF6-1
	F.6.1 General.F6-1
	F.6.2 BenefitsF6-1
	F.6.3 Design Features.F6-1
	F.6.4 Transfer LanesF6-1
	F.6.5 Basket WeavesF6-2
APPENDIX	- Typical Designs	FA-1
		to
		FA-15

CHAPTER F
INTERCHANGES
CONTENTS

Figures

F3-1	Four-leg Interchanges Between Freeways	F3-2
F3-2	Three-leg Interchanges Between Freeways	F3-4
F3-3	Simple Diamond Interchange	F3-6
F3-4	Split Diamond Interchanges	F3-7
F3-5	Parclo A Interchanges	F3-8
F3-6	Parclo B Interchanges	F3-9
F3-7	Parclo A-B, Trumpet and Rotary Interchanges.	F3-10
F3-8	Interchanges Between Roads Other than Freeways.	F3-12
F4-1	Interchange Spacing on Urban Freeways	F4-3
F4-2	Consistency of Exits	F4-4
F4-3	Lane Balance	F4-5
F4-4	Coordination of Lane Balance and Basic Lanes.	F4-6
F4-5	Auxiliary lanes	F4-8
F4-6	Solutions to Undesirable Weaving	F4-9
F4-7	Design Chart for Weaving	F4-10
F4-8	Lane Continuity	F4-12
F4-9	Route Continuity.	F4-13
F4-10	Freeway/Service Road Systems	F4-14
F4-11	Express/Collector System	F4-16
F5-1	Ramp Design Elements.	F5-1
F5-2	Single-Lane Exit Terminal Configuration	F5-4
F5-3	Two-Lane Freeway Exit Terminal Configuration	F5-5
F5-4	Three-Lane Freeway Exit Terminal Configuration	F5-6
F5-5	Exit Terminal Bullnose and Offset Dimensions	F5-7
F5-6	Sight Distance at Exit Terminals.	F5-8
F5-7	Distance Travelled During Deceleration	F5-10

CHAPTER F
INTERCHANGES
CONTENTS

Figures

F5-8	Single-Lane Entrance Terminal Configuration	F5-14
F5-9	Two-Lane Freeway Entrance Terminal Configuration	F5-15
F5-10	Three-Lane Freeway Entrance Terminal Configuration	F5-16
F5-11	Entrance Terminal Bullnose and Offset Dimensions	F5-17
F5-12	Sight Distance at Entrance Bullnose	F5-18
F5-13	Sight Distance at Entrance Terminals.	F5-18
F5-14	Distance Travelled During Acceleration	F5-20
F5-15	Successive Entrance Ramps.	F5-23
F5-16	Ramp Types	F5-24
F5-17	Ramp Terminal Spacing	F5-25
F6-1	Weaving on Collector Lanes Due to Transfer Lanes	F6-2
FA-1	Single-Lane Crossing Road Exit Terminal	FA-1
FA-2	Single-Lane Freeway Exit Terminal	FA-2
FA-3	Two-Lane Freeway Exit Terminal, 110 km/h	FA-3
FA-4	Two-Lane Freeway Exit Terminal, 120 km/h	FA-4
FA-5	Single-Lane Crossing Road Entrance Terminal	FA-5
FA-6	Single-Lane Freeway Entrance Terminal	FA-6
FA-7	Two-Lane Freeway Entrance Terminal	FA-7
FA-8	Major Fork	FA-8
FA-9	Parclo A-2 Crossing Road Terminal.	FA-9
FA-10	Parclo A-4 Crossing Road Terminal, One Left-Turning Lane.	FA-10
FA-11	Parclo A-4 Crossing Road Terminal, Two Left-Turning Lanes	FA-11
FA-12	Parclo B-2 Crossing Road Terminal.	FA-12
FA-13	Parclo B-4 Crossing Road Terminal.	FA-13
FA-14	Transfer Roadway; Collector to Express Lanes	FA-14
FA-15	Transfer Roadway; Express to Collector Lanes	FA-15

CHAPTER F
INTERCHANGES
CONTENTS

Tables

F2-1	Selection of Interchanges, Grade Separations and Intersections based on Classification	F2-2
F5-1	Ramp Design Speed	F5-3
F5-2	Sight Distance at Exit Terminals.	F5-8
F5-3	Length of Speed-Change Lanes at Exit Terminals on Crossing Roads	F5-12
F5-4	Length of Speed-Change Lanes at Exit Terminals on Freeways for single-Lane Ramps	F5-12
F5-5	Length of Speed-Change Lanes at Exit Terminals on Freeways for Two-Lane Ramps	F5-13
F5-6	Grade Factors for Exit Speed-change Lanes.	F5-13
F5-7	Sight Distance at Entrance Terminals.	F5-18
F5-8	Length of Speed-Change Lanes at Entrance Terminals on Crossing Roads and Freeways	F5-21
F5-9	Grade Factors for Entrance Speed-Change Lanes	F5-22

F.1 INTRODUCTION

F.1.1 General

Interchange design is a form of intersection design and the designer is referred to the material in Chapter E, At-Grade Intersections, in using this chapter. An interchange may be a good solution to a problem encountered in an at-grade intersection as it permits high traffic volumes to operate safely on the intersecting roadways. An interchange, as distinct from a grade separation, provides at least one connection for traffic between intersecting roadways. Crossing conflicts are eliminated by grade separation, and turning conflicts are minimized, depending on the configuration of the particular interchange.

Although the design of each interchange is an individual task, it should be considered in conjunction with the design of adjacent interchanges or at-grade intersections. An interchange, or series of interchanges, on a freeway through a community may affect large contiguous areas or even the entire community. Interchanges are located and designed so that they provide the best possible traffic service consistent with community interests.

F.1.2 Design Considerations

An interchange is a component in a highway system, and as such it should be designed individually to meet the particular needs taking in local considerations that will influence the design. Of equal importance, an interchange is part of an overall highway system of components providing for through travel and access to development. Since the components of a highway system work in concert with each other, having mutual influence, the features and configuration of other components must be taken into account in interchange design.

There are a number on interchange types from which the designer may select the one most suitable for the prevailing conditions, and the selection is influenced by a number of design considerations the most important of which are:

- . classification
- . adjacent land use
- . design speed
- . traffic volumes
- . composition of traffic
- . environmental considerations
- . economics
- . safety
- . topography
- . right-of-way and property
- . relationship to other features of the highway system

In special cases, certain unusual configurations of interchanges may be appropriate; however, in developing such interchange, most of the above design considerations should be taken into account.

F.1.3 Design Features

Traffic entering an interchange on one of the approach roads either remains on the through road or makes a turning movement by means of a ramp or turning roadway. The driver passing through should be disturbed as little as possible by exiting and entering traffic, and should have no difficulty in recognizing that the through roadway is the correct one for his destination. The driver making a turn should recognize that, for his destination, he has to negotiate one or more ramps and should be prepared for this in sufficient times to make the manoeuvre safely. This can be accomplished by the application of some basic design principles of interchange design.

In the process of manoeuvring through an interchange, a driver has a number of tasks to execute successfully to avoid becoming a hazard to himself and other road users. He is required to select a suitable speed, adjusted up or down when required, choose appropriate lanes and successfully make diverging and merging manoeuvres where appropriate. To maintain and promote safety in carrying out all of these tasks, it is important that the driver understands the operation of the interchange so that he is not misled or surprised by some characteristic that may cause him to behave in an erratic manner. Driver understanding is best promoted by the provision of consistency and uniformity in the type selected, the design of the interchange features and route continuity and uniformity and signing. It is important that the design reflect normal driving habits.

To maintain consistency and uniformity, interchange ramp exits and entrances are almost invariably on the right-hand side of the roadway (looking in the direction of traffic) and left-hand entrances and exits should only be considered under special conditions. Apart from driver understanding, there are practical advantages in placing entrances and exits to the right, such as elimination of weaving, avoiding low-speed vehicles in the fast lane, convenience of merging manoeuvres and minimizing property requirements.

In general an interchange should have only one exit from a freeway in each direction, the division of traffic for alternative destinations taking place elsewhere. This minimizes the number of decisions the driver has to make at any one time.

Travel between through roadways is by ramps, which may be either direct, semi-direct or loop. Direct and semi-direct ramps provide for higher speed travel, inner loop ramps are commonly used in interchange, and are satisfactory for many manoeuvres. In general, inner loop ramps are applied where the exit to the loop ramps are applied where the exit to the loop is from a relatively low speed roadway and are to be avoided where the exit is from high speed roadways such as freeways, since the need for rapid reduction in speed may surprise the driver.

For any travel movement provided from one road to another within an interchange, it is important to provide the return movement in most cases.

INTERCHANGES

In most interchanges a freeway intersects with an arterial road, and the question of whether to carry the freeway over or under the arterial arises. The choice depends on a number of considerations, in particular terrain, construction cost and the need for stage construction. There are a number of advantages in carrying the freeway under the arterial road.

On rural freeways, in which crossing roads and interchanges may be widely spaced, drivers travelling long distances might become fatigued and the view of bridge structures carrying crossing roads over the freeway provides a change of scene to assist in relieving boredom. The view of a crossing road over the freeway will also alert the driver to the presence or possible presence of an interchange assisting him to locate the desired exit. Carrying the freeway under the crossing road tends to generate exit ramps on up-grades assisting in deceleration, and entrance ramps on down-grades assisting in acceleration.

Most exits from the freeway occur in advance of the structure, and exit ramps on up-grade will usually offer the driver good visibility and sight distance to the exit bullnose and a view of the exit ramp itself in time to allow the driver to adjust speed and make a safe manoeuvre on the ramp itself. Exit terminals on arterial roads crossing freeways, on the other hand, are beyond the structure, and it is advantageous for the crossing road to be carried over the freeway providing better visibility to the exit terminals.

INTRODUCTION

Freeways in cut assist in reducing noise, the sound being confined between the cut slopes, and truck noise on ramps is reduced if exit ramps are on up grades and entrance ramps are on down grades.

If a freeway or major divided arterial road is to have an interchange at a crossing road ultimately and an intersection initially, the interchange is more readily introduced if the crossing road is carried over.

The design features discussed above are described in general terms only, and the opportunity to introduce desirable features has to be assessed against other considerations for each particular design.

The principles of alignment design and cross section elements discussed in Chapters C and D apply to interchanges and interchange systems discussed in this chapter, and they should be referred to in the course of interchange design.

Signing is an important aspect of interchanges, and its design should be carried out in conjunction with the geometric design.

Additional specific design features are described in Sections F4 & F5.

F.2 WARRANTS

F.2.1 General

The introduction of an interchange is a valid solution to many of the problems experienced by at-grade intersections. However, the high initial construction cost, property cost and environmental impact may preclude the application of an interchange in many instances. A definitive set of warrants to justify the introduction of interchanges is not offered because of the many variable conditions and constraints that might prevail. The following paragraphs suggest a set of guidelines as the basis for consideration of the introduction of interchanges.

F.2.2 Classification

A freeway inherently precludes at-grade intersections, and all access to and from the highway is through interchanges. Roads crossing freeways which do not provide access are either grade-separated or terminated either side of the freeway. Crossing roads interchanging with freeways are normally arterial roads; however, in some cases it is appropriate to develop interchanges at collector roads or local roads where travel distance to adjacent arterial roads is excessive. In such cases, the interchanges may be carrying very low volumes although the interchange is justified in terms of safety and the continuity of service. Drivers on freeways expect to be able to continue travel without interruption, and would be surprised if confronted with an at-grade intersection. An interchange is justified, therefore, in terms of system continuity, even though crossing road volumes and turning volumes may be low.

Table F2-1 offers a guide to the section of interchanges, grade-separations and intersections, based on the classification of roads.

F.2.3 Traffic

Traffic volume in relation to available capacity is the most tangible warrant to justify the introduction of an interchange. Where demand volumes exceed capacity or desired service volumes, consideration may be given to increasing the capacity of an at-grade intersection or introducing an interchange. Interchanges are desirable at such locations, but may not be justified because of the high cost of construction and property. Reference should be made to Chapter B, Traffic and Capacity, to determine level of service as a justification for an interchange.

The elimination of bottlenecks where traffic volumes are high at isolated locations, by means of interchanges, is not necessarily confined to arterial roads. Such solutions may be appropriate where arterial roads intersect with collector roads or local roads, as indicated in Table F2-1, application 6.

F.2.4 Safety

Some at-grade intersections have high accident rates which cannot be lowered by improvement to the geometry of the intersection or through the application of traffic control devices, in which case it may be appropriate to introduce an interchange as a safety measure. Such intersections are often found at lightly travelled, low volume, rural locations where speeds tend to be high.

On heavily travelled rural arterial roads, particularly where there is a proliferation of strip development, accident rates tend to be high at intersection locations and the introduction of low-cost, relatively low quality interchanges might be a good solution to this problem. In such cases the presence of an interchange does not necessarily determine the classification as freeway, since the road is not fully controlled access and the driver still recognizes it as an arterial road.

F.2.5 Topography

Interchanges may be introduced at locations where topography precludes an at-grade intersection because it is either impractical or more costly.

F.2.6 User Benefits

High-volume at-grade intersections cause delay to most drivers, and a congested intersection delay all drivers. This incurs a cost in terms of waiting time, operating and maintenance costs of vehicles, and the introduction of interchanges usually reduces these costs, although for some movements travel distance may be longer. The reduced operating and maintenance costs and time saved have to be weighed against the cost of the interchange in order to confirm an economic benefit.

Table F2-1

**SELECTION OF INTERCHANGES, GRADE SEPARATIONS
AND INTERSECTIONS BASED ON CLASSIFICATION**

Rural	Freeway	Arterial	Collector/Local
Freeway	1	2	4
Arterial		6	7
Collector/Local			8

Urban	Freeway	Arterial	Collector/Local
Freeway	1	3	5
Arterial		6	6 or 7
Collector/Local			8

1. Interchange in all cases.
2. Normally interchange, but grade separation where traffic volume is light.
3. Normally interchange, but grade separation where interchange spacing is too close.
4. Normally grade separation or alternatively the collector/local may be closed.
5. Normally separation, but an interchange may be justified to :
 - . relieve congestion
 - . serve high density traffic generators
6. Normally intersection, but an interchange may be justified where:
 - . capacity limitation causes serious delay
 - . injury and fatality rates are high
 - . cost would be lower than an intersection
7. Normally intersection, or alternatively the collector/local may be closed.
8. Normally intersection, or alternatively one road may be closed.

F.3 INTERCHANGE TYPES

F.3.1 General

There is a wide variety of interchange types available to the designer, and the classification of the roads is the prime determinant in the selection of the most suitable interchange type for any particular application. Section F.3.2 deals with interchanges between roads classified as freeways, either four-leg or three-leg. Section F.3.3 discusses interchanges between freeways and other roads which are normally arterial roads but in some cases are collector roads. Section F.3.4 discusses suitable types of interchanges between roads, neither of which is a freeway. Such applications are normally between two arterial roads or an arterial road and a collector road. In rare instances there is an application for an interchange between an arterial road and a local road.

Most interchanges provide for all movements between intersecting roadways. Interchanges that provide a limited number of movements are referred to as a partial interchanges. For any movement provided for in a partial interchange the corresponding return movement should also be available, since the driver expects to be able to retrace his route in the return direction on any particular trip.

The selection of the most suitable interchange for any particular application, and the details of its design, depend on a number of controls and other considerations, among the most important of which are:

- . Highway classification
- . Degree of access control
- . Design speed
- . Traffic volume and traffic mix
- . Number of interchange legs
- . Traffic control devices
- . Topography
- . Right-of-way and property requirements
- . Service to adjacent communities
- . Systems consideration
- . Environmental impact
- . Economics
- . Safety

The relative importance of these controls and considerations varies between interchanges. For any particular site, each control should be examined and its importance assessed. Alternative types and configurations should then be studied to determine the most suitable in terms of the more important controls.

F.3.2 Interchanges Between Freeways

Interchanges between two freeways are normally the most costly in terms of construction cost and property requirements. However, their configurations tend to be simpler than those for other applications.

POLICY

SINCE FREEWAYS ARE FULLY-CONTROLLED ACCESS FACILITIES, IT IS INHERENT IN INTERCHANGES BETWEEN FREEWAYS THAT AT-GRADE INTERSECTIONS ARE INAPPROPRIATE AND IT IS MANDATORY THAT THEY BE AVOIDED.

Crossing traffic movements are accommodated either by weaving sections within the interchange or by vertical separation.

Fully-directional interchanges provide for right and left turns through large radius ramps having design speeds in the order of 70% to 80% of freeway design speeds and having overall deflection angles in the order of 90°. Partially-directional interchanges provide for some left-turn movements by means of loop ramps, which have lower design speeds. Partially-directional interchanges have applications where there are severe property limitations, significant environmental impact, or where some left-turn volumes are low.

Figure F3-1 illustrates fully-directional and partially-directional four-leg interchanges between freeways. The fully-directional type shown in illustration (i) provides single exits from all four directions and directional ramps for all eight turning movements. To maintain access control and to avoid at-grade intersections, the through roadways and ramps are separated vertically in four levels.

Partially-directional interchanges allow the number of levels to be reduced as the number of loops is increased. The single-loop arrangement, illustration (ii), and two-loop arrangement in (iii) and (iv), require three levels. A configuration such that the loop ramps are

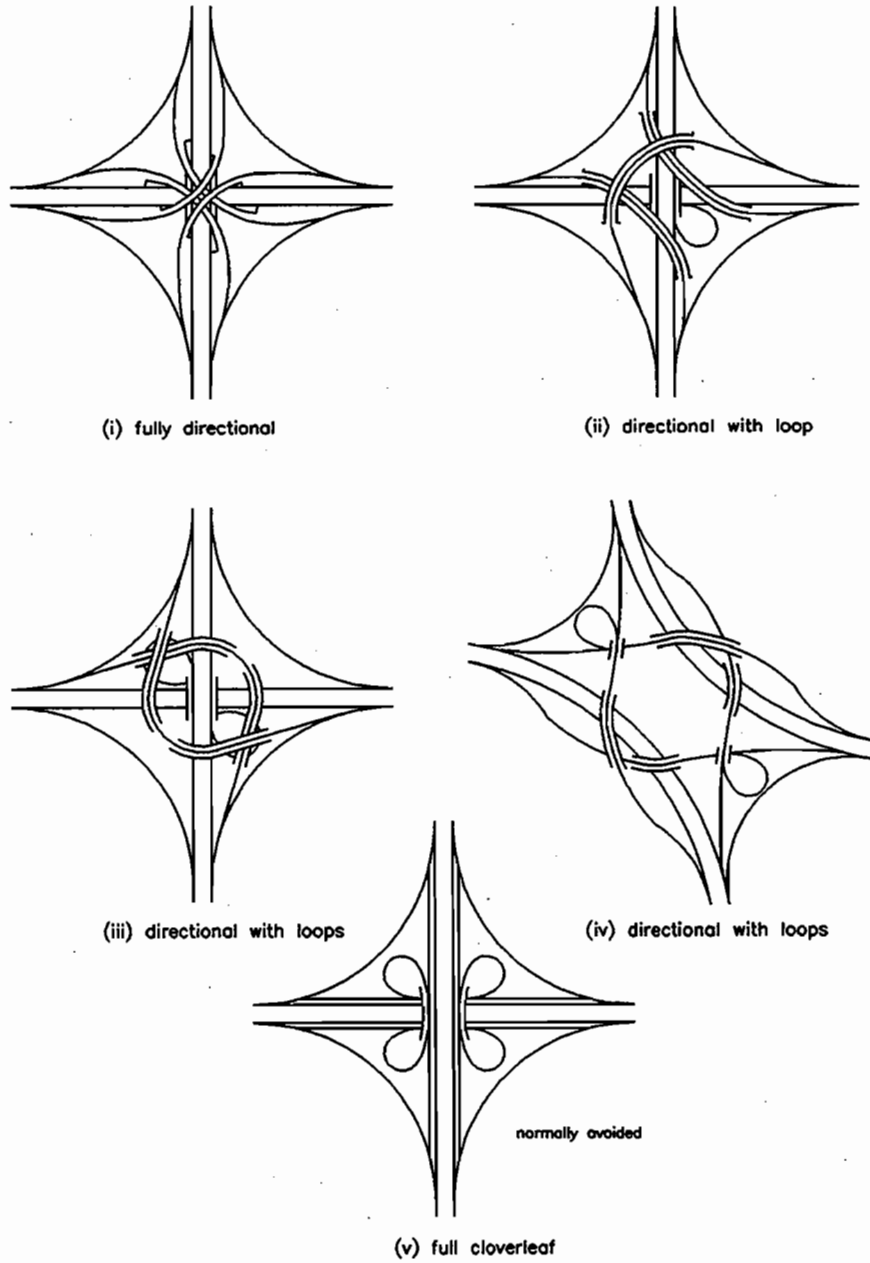

Figure F3-1
Four-leg Interchanges Between Freeways

INTERCHANGES

carrying the lighter volumes of left-turning traffic and levels arranged so that the loop ramps are on up-grades encouraging deceleration, increasing safety is preferable. Illustration (v) is a full cloverleaf with collector lanes incorporating loops for four left-turning movements and two levels separating the through roadways vertically. This type of interchange introduces undesirable weaving sections, and is only suitable where left-turn volumes are low and property is readily available. This design is normally avoided.

Figure F3-2 illustrates a variety of fully directional interchanges and partially - directional three-leg interchanges between freeways.

Illustrations (i) to (iv) are fully - directional interchanges requiring three levels of roadways and illustration (v) is partially-directional, requiring only two levels.

Illustrations (vi) and (vii) are referred to as trumpet interchanges and each incorporates one loop ramp for a left-turn movement. The choice between the two configurations depends on the availability of property, but desirably the loop should be carrying the smaller volume of the two left-turn movements.

F.3.3 Interchanges Between Freeways and Other Roads

In interchange types for this application, all ramps diverging and merging with the freeway should have acceleration and deceleration lanes so that traffic can enter and exit freeway lanes at, or close to, freeway speeds. Where the ramps connect with the crossing roads, at-grade intersections are commonly utilized, and are appropriate in many cases, controlled by suitable traffic control devices.

Left-turn movements often are accommodated on loop ramps, and loop ramps carrying traffic entering the freeway are preferable to loop ramps carrying exiting traffic. Where other considerations permit, it is desirable to arrange the levels of the through roadways so that ramp traffic entering the freeway is on a downgrade and ramp traffic exiting the freeway is on an upgrade, to assist in acceleration and deceleration.

INTERCHANGE TYPES

The choice of carrying the freeway over or under the crossing road depends in topography, cost, stage construction and other environmental considerations. There are a number of operational advantages in carrying the freeway under the crossing road.

- exit ramps are usually on up-grades, assisting in deceleration
- entrance ramps are usually on downgrades, assisting in acceleration
- sight distance on the freeway to the exit bullnose is usually superior
- at-grade intersections on the crossing road, which may include such feature as left-turning lanes, traffic signals and other traffic control devices, are more readily visible to drivers on the crossing road approaching from the other side of the freeway
- the view of a bridge structure, to the freeway driver on the approach to the interchange, alerts the driver to the possible presence of an interchange, offering time to determine whether it is the desired exit and to make appropriate lane changes and adjustments in speed to take the exit.
- the view of the exit ramp to the freeway driver is usually superior
- the view, to the freeway driver, of crossing roads on structures crossing the freeway, assists the long distance freeway driver, who may experience boredom or tiredness, to remain alert
- freeways in cut tend to generate lower noise levels to surrounding communities than freeways in fill

Interchanges between freeways and other categories of crossing road normally provide for all turning movements. In some cases it may be preferable to

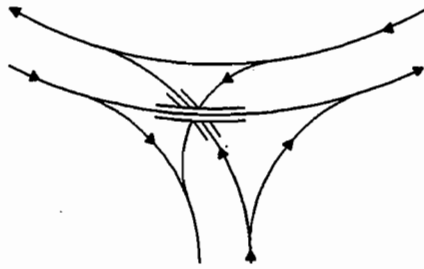

(i) fully directional

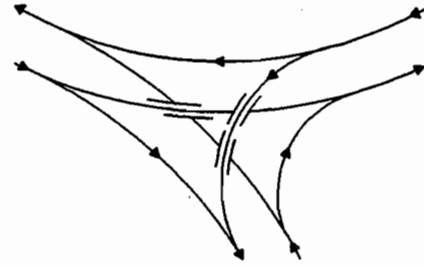

(ii) fully directional

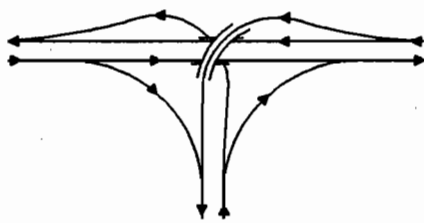

(iii) fully directional

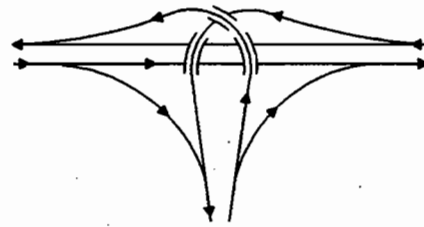

(iv) fully directional

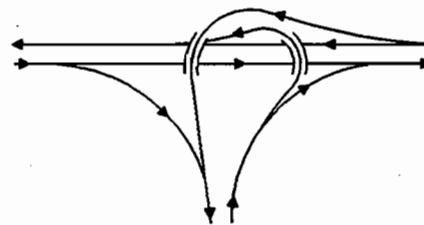

(v) partially directional

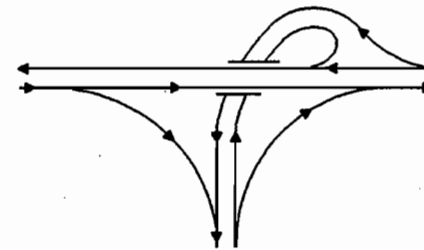

(vi) trumpet

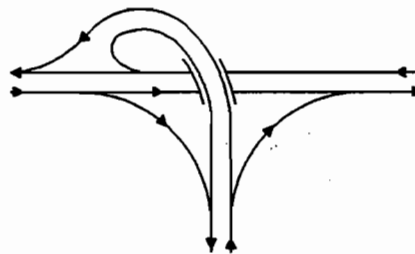

(vii) trumpet

Figure F3-2
Three-leg Interchanges Between Freeways

eliminate some turning movements; however, in such cases for any movement that is provided the corresponding return movement should also be available.

Figures F3-3 to F3-7 illustrate interchanges for application between freeways and arterial roads. They are shown diagrammatically with the arterial road crossing over the freeway and with single exit ramps from the freeway.

Figure F3-3 illustrates a diamond interchange. The ramps intersect with the crossing road at at-grade intersections controlled by traffic signals or, where volumes are low, by stop signs on the exit ramps. This interchange lends itself well to signing; it is simple to understand and is economical in property. It is generally limited in its ability to handle left-turning traffic at the intersections, although this can be alleviated by adding through lanes and left-turn lanes on the crossing road. Visibility for traffic on exit ramps at the crossing road intersections may be restricted to some degree, depending on the profile at the crossing roads and other design details. Signing on the crossing road and detailing of the intersections is important to avoid wrong-way movements on the exit ramps.

Figure F3-4 illustrates the split diamond interchange, having application to a pair of arterial streets either one-way or two-way, usually separated in the order of 100 m to 200 m. The one-way split diamond offers more capacity than the single diamond for a given area of bridge structure but has the disadvantage that all left-turns have to pass through three intersections. The two-way split diamond has application where a pair of two-way arterial roads are too close to provide separate interchanges. The overall capacity is lower than that of the one-way split diamond.

Figure F3-5 illustrates the Parclo A-4 and A-2. The Parclo A is a partial cloverleaf interchange with two inner loop ramps both located on the freeway approach in advance of the crossing road. The Parclo A-4 is generally regarded as the most effective interchanges between a freeway and an arterial road. It has superior operational qualities and where property, property cost, environmental, and other considerations permit, it is preferable to all others.

The Parclo A-4 differs from the diamond in that the left-turn movements from the crossing road are accommodated on loop ramps. Right-turn movements from the crossing road are isolated from the intersections on the crossing road, and the only crossing manoeuvres at the intersections are the left-turn traffic exiting from the freeway and the through traffic on the crossing road. This allows two-phase signal operation. For a given area of bridge structure, the capacity is superior to that of the diamond. The Parclo A-4 lends itself to signing which can be readily understood by the driver, and does not encourage wrong-way movements on exit ramps.

The Parclo A-2 differs from the Parclo A-4 only in that the right-turn ramps from the crossing roads are accommodated by left-turn roadways to the loop ramps. This has the advantage of eliminating property requirements in two quadrants, but reduces capacity through the intersection on the crossing road requiring three-phase operation if the intersection is signalized, and left-turn volumes are high. The capacity through the intersections can be increased by the addition of through lanes on the arterial road. This form of interchange may suit particular sites where property is a significant consideration, or may also be regarded as a stage of Parclo A-4.

Figure F3-6 illustrates the Parclo B-4 and B-2. The Parclo B is a partial cloverleaf with two inner loop ramps, both located on the freeway approach beyond the crossing road. In the Parclo B-4, left-turn movements from the freeway are made through loop ramps and left turn movements from the crossing road are through at-grade intersections, having two-phase operation if signals are required. Capacity on the crossing road is higher than for the Parclo B-2 since one through movement at each intersection does not have to stop. Movements from the freeway do not have to pass through a signal reducing the possibility of traffic backing up on the freeway.

The Parclo B-2 is the same as the B-4, but with right-turn movements from the freeway to the crossing road made through the loop ramps and additional left-turn roadways. This form of interchange has the advantage

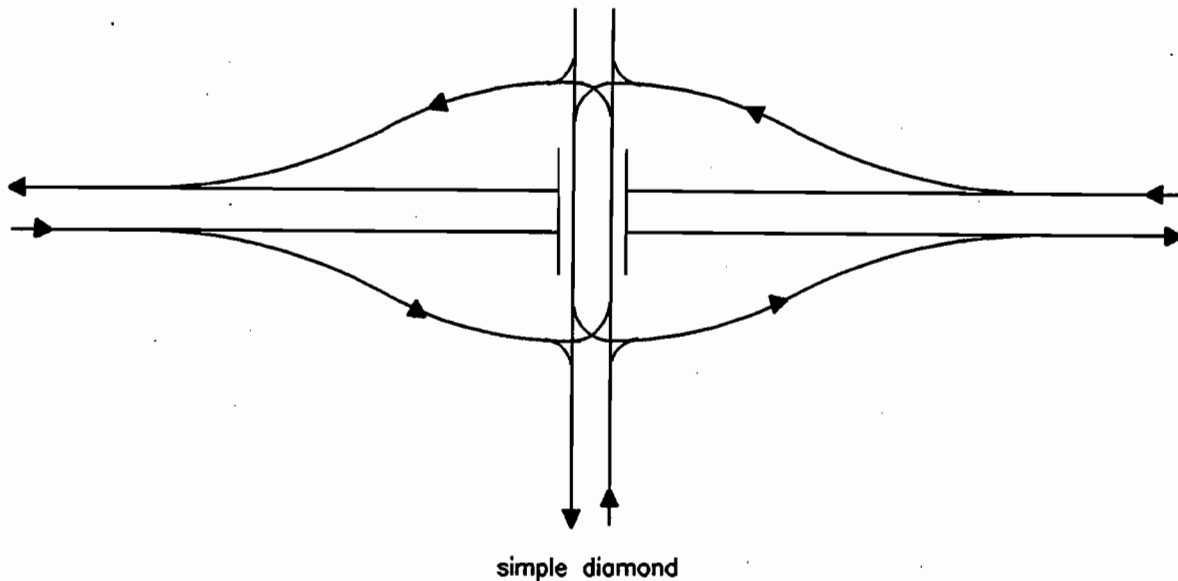

advantages

- * high standard single exits in advance of the structure.
- * high standard single entrances beyond the structure.
- * economical in property use and construction costs.
- * where the freeway is depressed, the grades of the ramps assist the deceleration of exiting traffic and the acceleration of entering traffic.
- * single exit feature simplifies signing of freeway.
- * no need for speed change lanes on or under the structure.
- * no weaving on the freeway.

disadvantages

- * lower capacity on the minor road due to left turning movements.
- * difficulty of obtaining adequate visibility at the open throat ramp terminals especially where the minor road crosses over the freeway.
- * many points of conflict on the minor road increase the accident potential of the design, unless signalized.
- * possibility of wrong-way movements.
- * turning traffic from the freeway is obliged to stop at the minor road, storage lane treatment may be required.
- * little possibility of allowing for future expansion of the interchange but increased volumes may be handled by:
 - (a) channelizing the open throats
 - (b) installing signals on the minor road (three phase), or
 - (c) providing two-lane left turns.

Figure F3-3
Simple Diamond Interchange

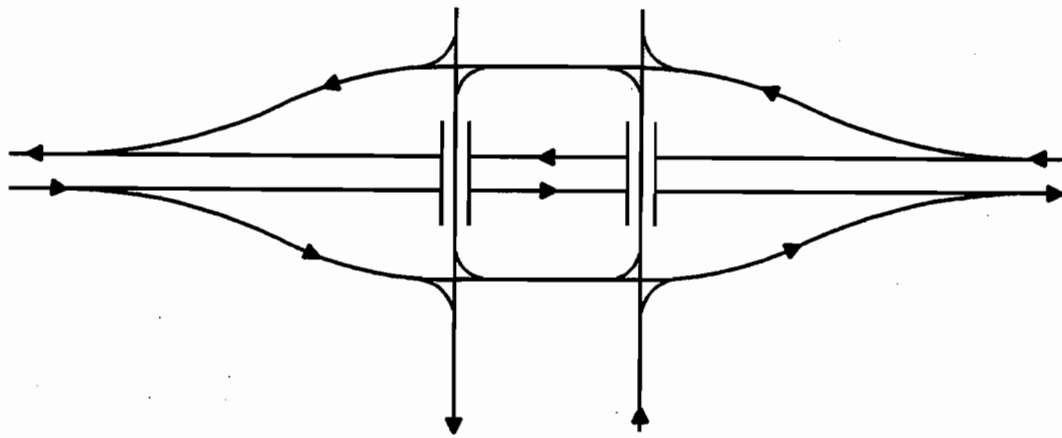

one-way split diamond

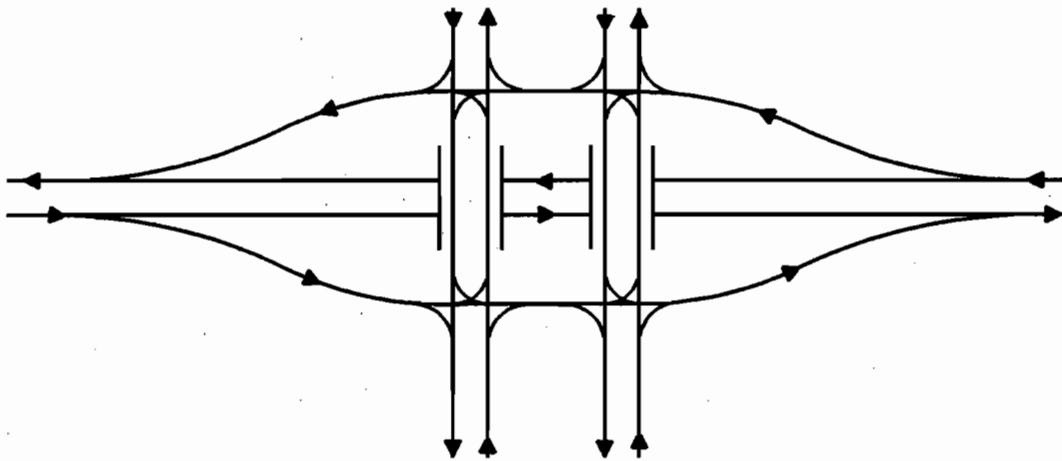

two-way split diamond

advantages

- * high standard single exits and entrances.
- * economical in property use and construction costs.
- * where the freeway is depressed, the grades of the ramps assist the deceleration of exiting traffic and the acceleration of entering traffic.
- * single exit feature simplifies signing of freeway.
- * no need for speed change lanes on or under the structures.
- * no weaving on the freeway.
- * increased capacity over the other forms of diamond interchanges.

disadvantages

- * additional structure required.
- * possibility of wrong-way movements.
- * stop on minor road for left turn.

Figure F3-4
Split Diamond Interchanges

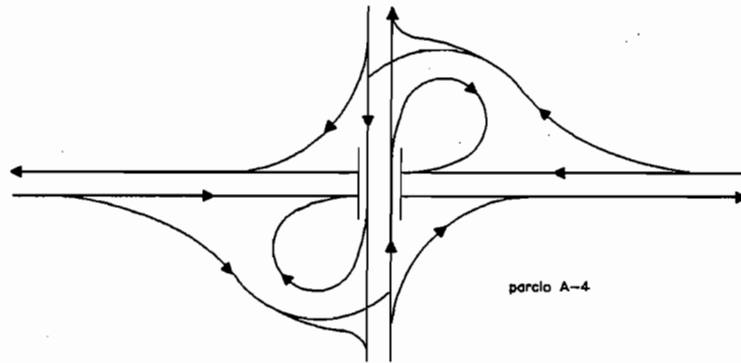

advantages

- * favours the fast freeway traffic by placing exit terminals in advance of structure.
- * weaving is eliminated.
- * single exit features simplifies signing of freeway.
- * high capacity.
- * all traffic movements are natural.
- * stop for left turns confined to ramps only.

disadvantages

- * higher construction and property costs than parclo 2 - quadrant or diamond.
- * signals required on minor road when through and turning volume high.

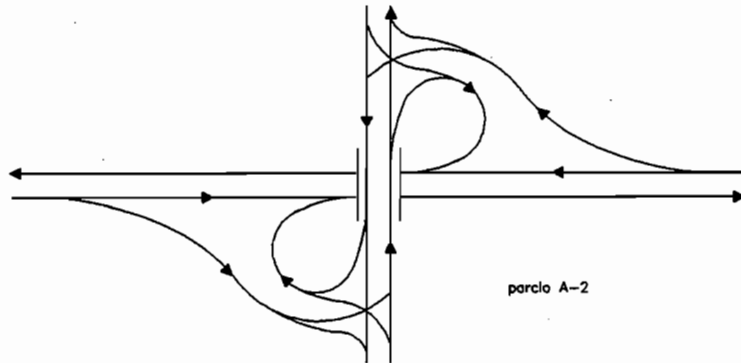

advantages

- * favours the fast traffic by placing exit terminals in advance of structure.
- * weaving is eliminated.
- * single exit features simplifies signing of freeway.
- * may be used as stage 1 of parclo A-4 as it lends itself to future expansion provided the structure opening is wide enough to accommodate the extra lanes.

disadvantages

- * natural right turn is replaced by a left turn from the minor road.
- * points of conflict on the minor road at the ramp terminals limit capacity and safety.
- * stop condition on the minor road for left turn movement. Left turn storage lane may be required on the minor road.

Figure F3-5
Parclo A Interchanges

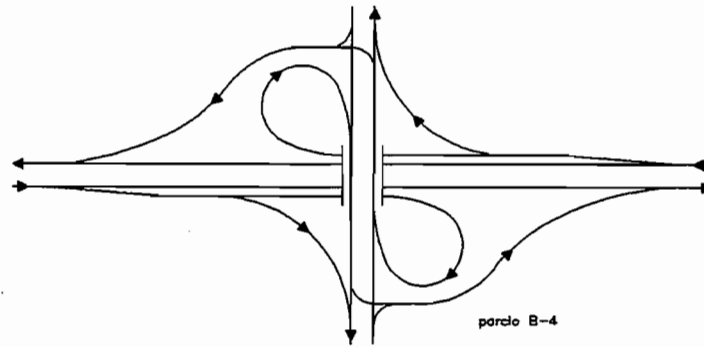

advantages

- * weaving is eliminated.
- * not conducive to wrong way movement.
- * all traffic movements are natural.
- * favours freeway traffic with advanced exit terminals.
- * single exits on freeway simplifies signing.
- * ramp traffic entering crossing road does not stop.
- * only one movement stops for signal.

disadvantages

- * higher construction and property costs than parclo 2 - quadrant or diamond.
- * in urban conditions when the minor road has high through and left turning volumes, signals are required.
- * stop on minor road for left turn with storage on or under the bridge between ramps terminals.
- * high speed traffic must exit from freeway on a small radius loop.

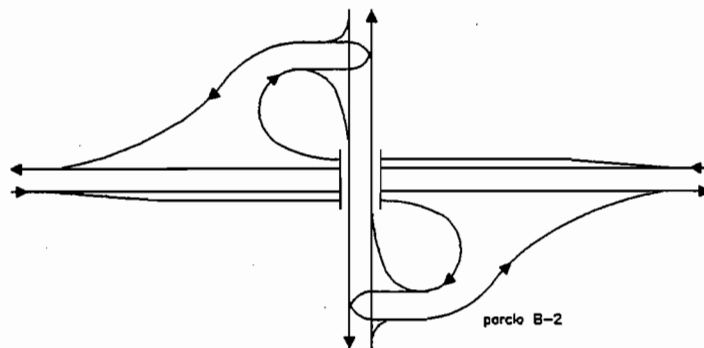

advantages

- * weaving is eliminated.
- * single exit features simplifies signing of freeway.
- * movements from the minor road are natural.
- * may be used as stage 1 of parclo A-4 as it lends itself to future expansion provided the structure opening is wide enough to accommodate the extra lanes.

disadvantages

- * points of conflict on the minor road at the ramp terminals limit capacity and safety.
- * right turn traffic from the freeway must come to a stop at the minor road.
- * left turn storage lane may be required on the minor road with storage on or under the bridge between the ramp terminals.
- * high speed traffic must exit from the freeway directly on to a small radius loop.

Figure F3-6
Parclo B Interchanges

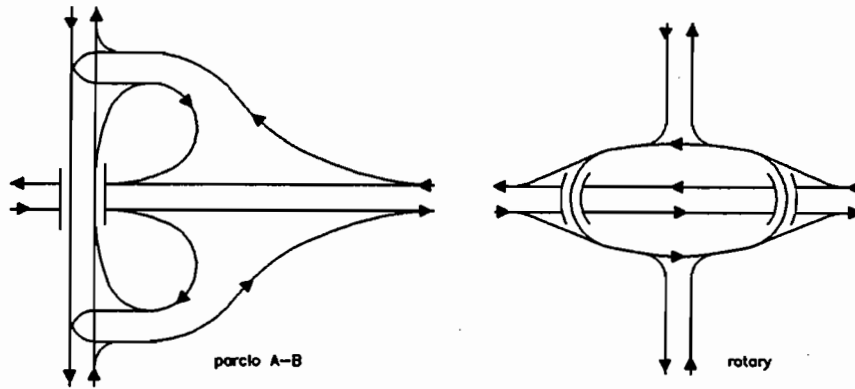

advantages

- * similar to parclos A-2 & B-2

disadvantages

- * similar to parclos A-2 & B-2
- * weaving section on crossing road.

advantages

- * this type provides a relatively simple solution for rural intersections with four or more approaches where speed and volumes are not high.

disadvantages

- * large property requirements
- * the weaving sections limit the speed and capacity.
- * the directional signing is difficult unless the diameter of the circle is large enough to provide adequate length in the weaving sections.

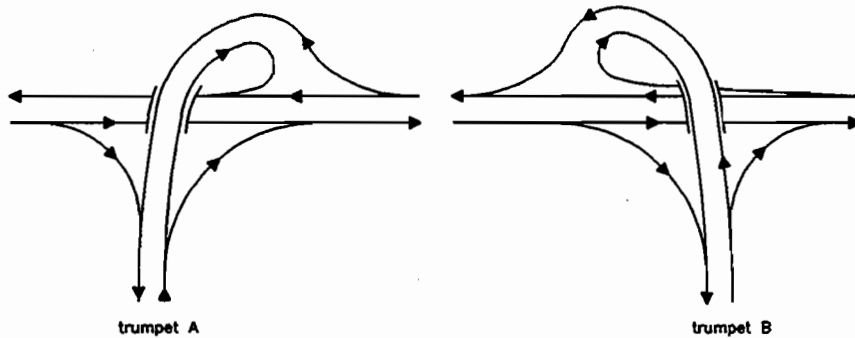

advantages

- * provides a relatively high speed semi-direct movement for heavier turning volume of traffic.
- * a single structure is required.
- * no weaving.
- * high capacity as all movements are free flow.

disadvantages

- * loop ramp traffic off high speed road (trumpet B).

Figure F3-7
Parclo A-B, Trumpet and Rotary Interchanges

of eliminating property requirements in two quadrants, but reduces intersection capacity compared with the Parclo B-4. This can be alleviated by increasing the number of through and turning lanes on the crossing road and exit ramps. If the intersections are signalized they may require three-phase operation.

Both the Parclo B-4 and B-2 have the serious disadvantage that traffic exiting from the freeway at high speed is required to decelerate significantly to negotiate the loop ramp. This feature surprises some drivers and loops carrying exiting traffic tend to have higher accident rates.

Figure F3-7 illustrates the Parclo A-B, trumpet and rotary interchanges. The Parclo A-B has loop ramps in adjacent quadrants, and has application where there are property restrictions in two adjacent quadrants on the same side of the crossing road. This form of interchange has similar capacity and operational features to the Parclo A-2 and Parclo B-2.

The rotary interchange has the advantage of eliminating intersections on the crossing road, but is generally not favoured because of its disadvantages of interrupting through traffic on the crossing road and introducing undesirable weaving sections. Unless the radius of the traffic circle is large, requiring considerable property, traffic exiting from the freeway may have difficulty adjusting speed and merging with traffic on the circle.

The trumpet interchanges have application to three-leg interchanges where an arterial road is terminated at a freeway. In the trumpet A, the loop ramp carries traffic from the arterial road to the freeway and in the trumpet B, the loop ramp carries traffic from the freeway. The trumpet A is generally preferred for operational reasons, however property considerations often dictate the choice. If property is severely restricted in all quadrants, an alternative treatment is a diamond interchange in which the crossing road is terminated at the freeway (not shown).

Interchanges between freeways and collector roads are normally those types offering lower capacity: the diamond, Parclo A-2, Parclo B-2 and Parclo A-B.

Multilevel directional interchanges are not suitable for application between freeways and arterials. In rural areas where capacity requirements are relatively low, the construction cost of such interchanges is

unjustified, and in urban areas property damage is usually high and unacceptable. Cloverleafs are generally inappropriate for this application of interchange, since weaving sections on both freeway and crossing road produce unacceptable interruption to through traffic. Weaving on the freeway can be eliminated by the introduction of collector lanes. The intensity of weaving on the crossing road is usually unacceptable, and all other considerations being equal a Parclo A-4 or B-4 will provide better operational qualities and characteristics, at lower property and construction cost, than the cloverleaf.

F.3.4 Interchanges Between Roads Other than Freeways

This section covers the interchange types for application:

- between two arterial roads
- between an arterial road and a collector road
- between an arterial road and a local road

Normally, where roads of these categories intersect, at-grade intersections are appropriate. If an interchange is required, it is due either to terrain or because an at-grade intersection cannot provide adequate capacity; for example, in areas of high traffic generation.

The interchanges used are usually the lower capacity type, in particular, the diamond, the Parclo A-2, Parclo B-2, Parclo A-B. Normally the orientation of the interchange is such that the intersections are located on the minor road or the road of lower volume. This allows the more major or higher volume road to operate relatively freely, and to provide higher capacity.

Figure F3-8 shows interchanges suitable for roads other than freeways that are not applicable to freeways. Illustrations (i) and (ii) are similar in configuration to Parclos A-2 and B-2 respectively, but have lower quality geometric features. They have applications on rural arterial roads where it is desirable to introduce a median barrier or otherwise eliminate left-turning traffic on the arterial. Illustration (iii) confines all turning movements to one quadrant, and has application where turning volumes are low yet it is desirable to separate through traffic movements.

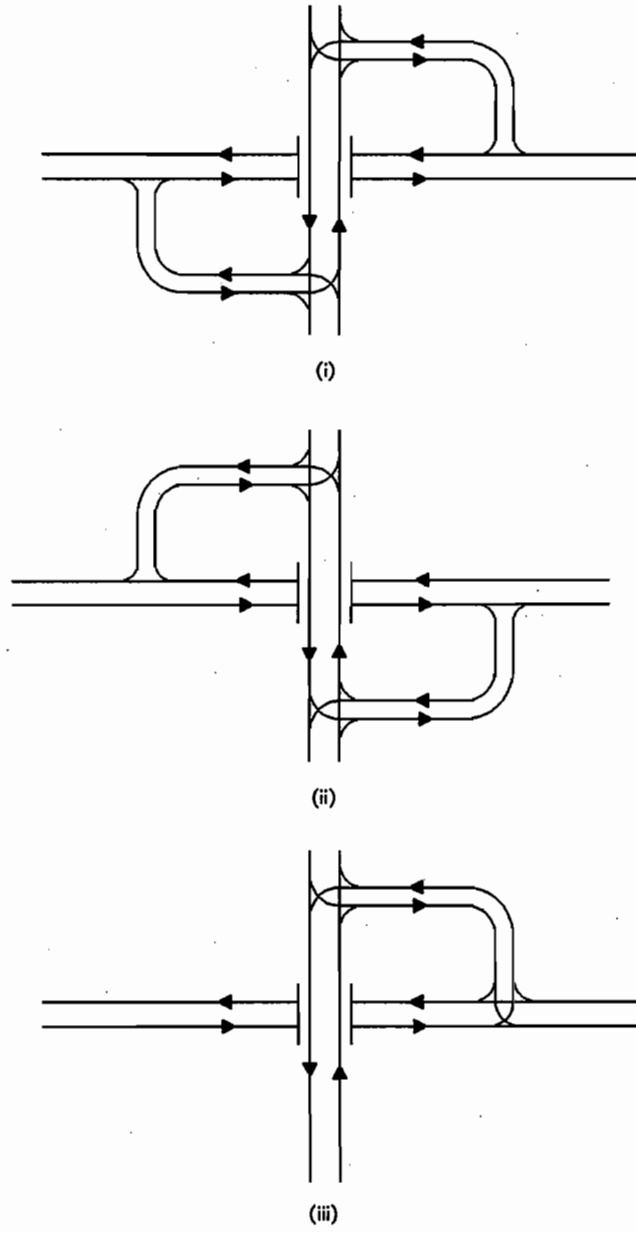

Figure F3-8
Interchanges Between Roads Other than Freeways

F.4 SYSTEMS CONSIDERATION

F.4.1 General

The selection and design of individual interchanges is strongly influenced by site specific engineering, environmental, topographical and operational considerations. However, an interchange is one element of a freeway system whose features influence the operation of each other. Freeway design elements and interchange design are so intimately related that they cannot be dealt with in isolation. For the purpose of geometric design, it is essential to treat a length of a freeway and its associated interchanges as a single system, so as to ensure proper balance of features and consistent operational quality.

This section deals with the mutual interaction of interchange and freeway design elements.

F.4.2 Interchange Location and Spacing

Rural freeways passing close to or through communities require interchanges suitably located to serve the needs of the community. It is sufficient to provide one interchange for small communities; larger communities require more. The precise location depends on the particular needs of the community; however, as a general guide, interchanges should be located at arterial roads recognized as major components in the road system, having good continuity and a capability for expansion if required. Interchanges should be located in the proximity of major development areas; for example, central business areas and areas of existing or future concentrations of commercial development. As a general guide in rural areas, interchanges are normally spaced at between 3 km and 8 km.

On urban freeways traffic conditions and driver behaviour are different from those of rural freeways, and this influences interchange spacing. Operating speeds tend to be lower, trip lengths shorter, traffic volumes higher, and drivers are accustomed to, and anticipate the need for taking a variety of actions in rapid succession. Interchanges spaced at more than 3 km over a length of urban freeway normally cannot provide the overall capacity to give adequate service to urban development, and closer interchange spacing is called for. If successive interchanges on urban freeways are too close, the operation of the freeway becomes seriously impaired and the freeway loses its capacity to collect and deliver traffic from the crossing arterial roads.

Interchange spacing in urban areas generally ranges from 2 km to 3 km. Interchanges should be located at major arterial roads, forming part of the arterial system of roads for the urban area and providing, or having the potential to provide, capacity to deliver to and collect from the interchanges.

If the arterial roads are spaced closer than 2 km, it is necessary either to omit some of the interchanges in favour of grade separations or adopt some alternative means of combining interchanges to serve closely located arterial roads. Figure F4-1 illustrates how this might be done. In the upper diagram the arterial roads are spaced at 2 km to 3 km, allowing each arterial to be served by its own interchange. In the lower three diagrams the arterial roads are at less than 2 km, calling for some form of combined ramp system to provide the overall interchange ramp capacity to serve the arterial system. The most suitable configurations of ramps are very much site specific, and the design is dependent on the layout of the arterial network and the particular needs of the community it serves.

F.4.3 Coordination of Interchanges

The configuration of an individual interchange should suit the particular location, taking into account topographical features, engineering and environmental considerations, and its capability to provide service to the community. In addition, the configuration of a series of interchanges over a given length of urban freeway should be examined to ensure that they meet driver expectations and match driver behaviour. These considerations are particularly important in urban areas where interchanges are closely spaced.

Driver understanding and smooth flowing operation are best promoted by consistency of interchange features and regularity of operation. The design of a series of interchanges, therefore, is a matter of compromise between the site specific needs of individual interchanges and the operation of a set of interchanges regarded as a freeway system.

Some of the earlier freeways incorporated left and right exits, and entrances might have been appropriate for certain individual interchange needs, the use of both left and right exits on a single length of freeway promotes uncertainty in the driver's mind and unnecessary lane changing and turbulence in the traffic flow. It is now generally accepted that all exits and entrances to freeways should be on the right, unless there is overwhelming reason to do otherwise. Exclusively right exits are reassuring to the driver, and allow him to concentrate on the many other activities he is required to perform.

Studies have shown that exit ramps tend to be high accident locations in interchange areas, and good visibility to exit bullnoses is an important consideration. Ramp exits ahead of underpass structures are more readily visible to drivers, and allow them to position the vehicle and adjust the speed well in advance so as to make a safe manoeuvre. Ramp exits beyond structures are less visible to driver.

A single exit at an interchange is preferable to multiple exits, simplifying signing and the decision-making process of the driver, allowing time to separate choices; first, to be assured that it is the correct exit and second, to determine which direction on the crossing road to take. Figure F4-2 illustrates treatment of a set of interchanges to ensure consistency of exits.

For these reasons, that exits ahead of underpass structures and single exits are preferable, it is desirable to maintain single exits ahead of structures throughout a length of freeway. Individual designs at successive interchanges can usually be adjusted without detriment to provide this regularity in design.

Maintenance of basic lanes, lane balance and the proper design of weaving sections are important to maintaining smooth operation, flexibility and level of service on the freeway. The configuration and design of interchange ramps should be reviewed, and adjusted if necessary, to match the requirements of these features.

F.4.4 Lane Balance and Basic Lanes

F.4.4.1 Lane Balance

For smooth and efficient operation through an interchange, these should be a balance between the number of traffic lanes on the highway and the ramps. The minimum number of lanes required is initially determined from the design traffic volumes and capacity analysis. However, in some instances it is desirable that the number of lanes should be increased to promote smooth safe operation, and to accommodate variations in traffic patterns.

The following principles should be applied to ensure lane balance after the minimum number has been established:

- the number of lanes downstream of the merging of two traffic streams should be equal to or one less than the sum of all traffic lanes on the merging roadways, shown in Figure F4-3;
- the number of lanes on a highway and ramp downstream of an exit roadway should be equal to or preferably one more than the number of lanes on the highway approach shown in Figure F4-3;
- where two lanes of traffic diverge from a highway on a ramp, the number of lanes on the highway should be reduced by one downstream of the ramp exit;
- the highway, in one direction of travel, should be reduced by not more than one traffic lane at a time. An exception to this may be at a major fork where the number of lanes on the highway may be reduced by two lanes downstream of the exiting roadway.

Typical examples of proper lane balance are shown in Figure F4-3.

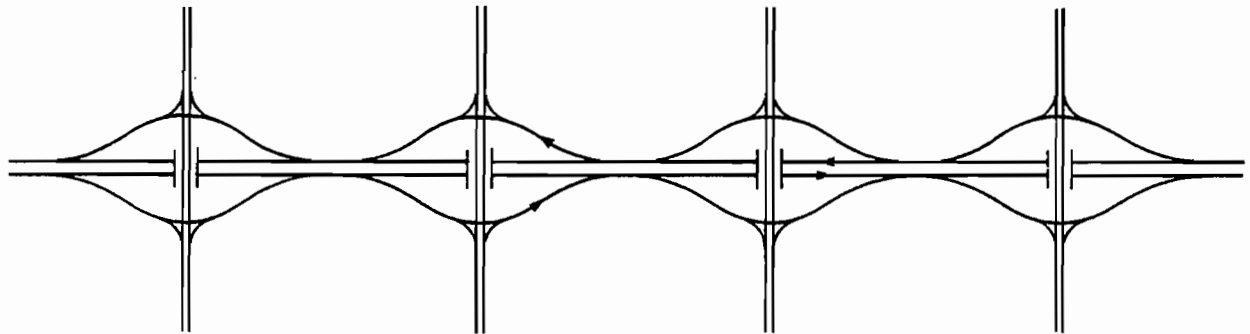

arterial roads at 2 km to 3 km spacing
each served by an interchange

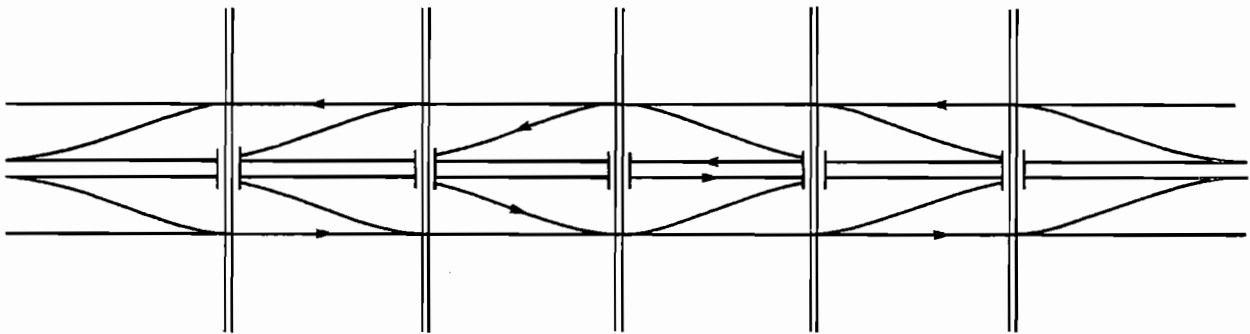

arterial roads at less than 2 km spacing
served as a group by ramp nesting

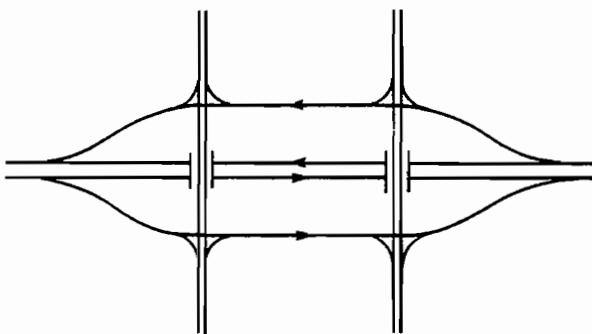

arterial roads at less than
2 km spacing served by
a combined interchange

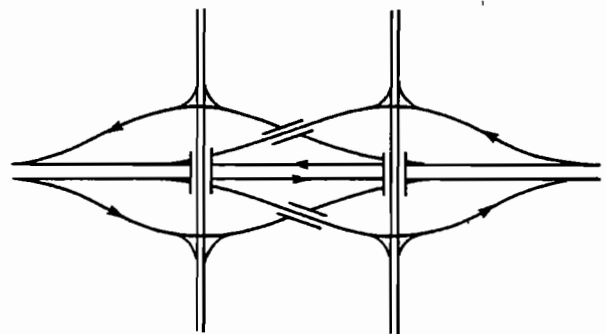

arterial roads at less than
2 km spacing served by
grade separated interchanges

Figure F4-1

Interchange Spacing on Urban Freeways

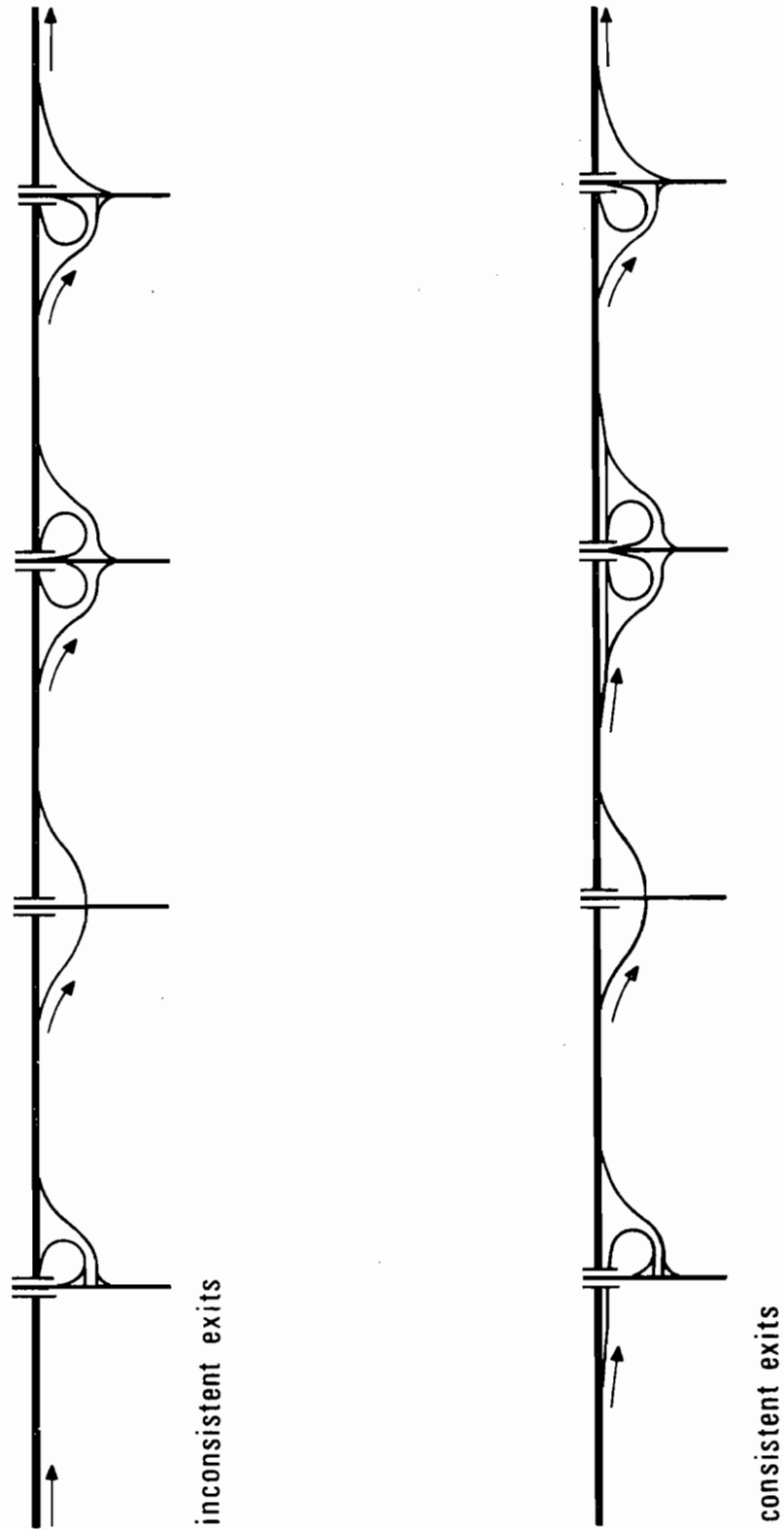
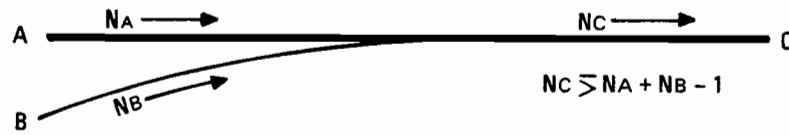

Figure F4-2
Consistency of Exits

general case
merging



general case
diverging



typical example

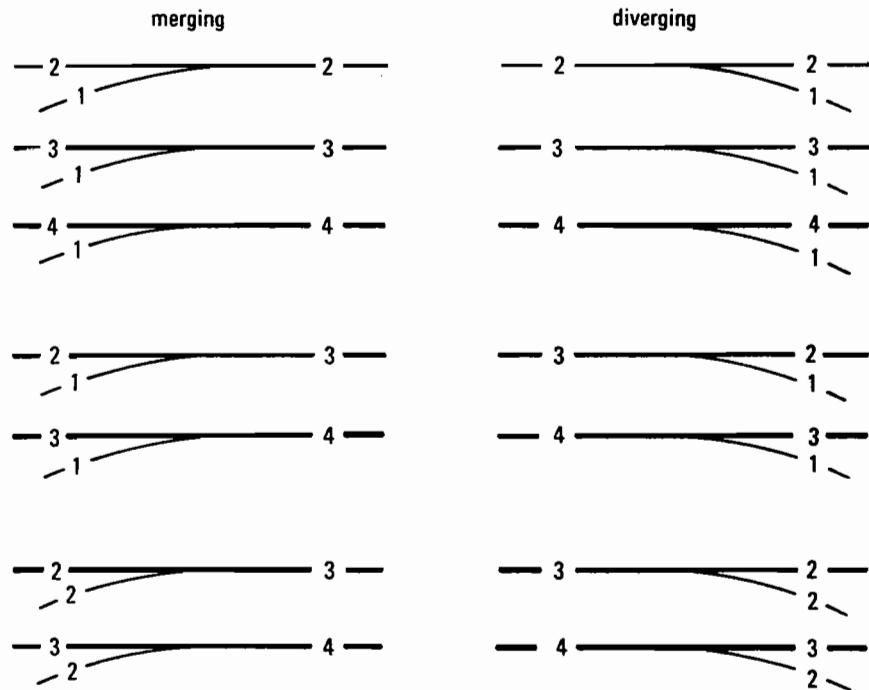
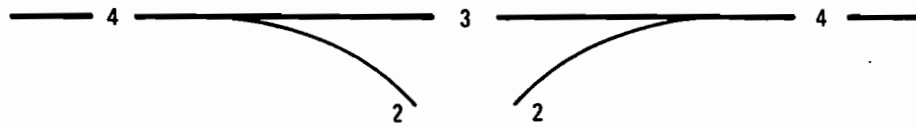
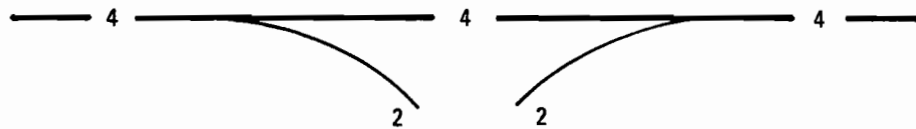

Figure F4-3

Lane Balance



lane balance but no compliance with
basic number of lanes
(i)



no lane balance but compliance with
basic number of lanes
(ii)

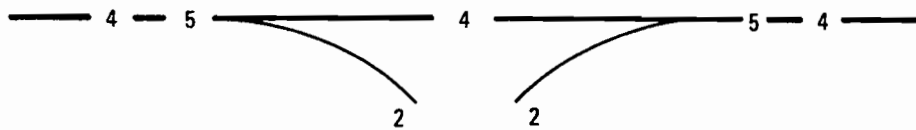

compliance with both lane balance and
basic number of lanes
(iii)

Figure F4-4

Coordination of Lane Balance and Basic Lanes

F.4.4.2 Basic Lanes

A highway route between identifiable geographic locations, or a significant length of such a route, is regarded as having a given number of lanes known as basic lanes. Maintenance of the basic number of lanes is essential for uniformity in service. Sections where the number of lanes has been reduced for reasons of capacity can become bottlenecks when unusual traffic conditions occur. Common instances are the demands created by accidents, maintenance operations, road closings or special events.

The number of basic lanes is changed only where there is a significant change in the general level of traffic volumes, for example, at an interchange between two freeways, in which case the change in basic lanes is by not more than one in each direction. Maintenance of basic lanes is essential on freeways, and is desirable on arterial roads.

F.4.4.3 Coordination of Lane Balance and Basic Lanes

Figure F4-4 illustrates coordination of lane balance and basic lanes. In each illustration the through roadway has four basic lanes and a two-lane exit followed by a two-lane entrance.

In illustration (i) lane balance is maintained, but there is no compliance with the basic number of lanes. This causes confusion and erratic operations for through traffic on the freeway. Furthermore, even though traffic volumes are reduced through the interchange there is no assurance that this pattern of traffic will prevail under all circumstances. Unduly large concentrations of through traffic might be caused by special events, closures or reduction in capacity of other parallel facilities because of accidents or maintenance operations. Under such circumstances, any lanes which have been dropped on a freeway within interchanges (based on capacity as dictated by the normal design hour volumes) can produce bottlenecks.

The arrangement shown in illustration (ii) provides continuity in the basic number of lanes but does not conform with the principles of lane balance. With this arrangement, the large exiting or entering traffic volume requiring two lanes has difficulty in diverging from or merging with the freeway flow.

Illustration (iii) shows an arrangement in which the concepts of lanes balance and basic number of lanes are brought into harmony by means of adding auxiliary lanes. In this manner, lane balance and maintenance of basic lanes are both realized.

Where an auxiliary lane is extended beyond an entrance to maintain both lane balance and basic lanes, the lane

should be continued for at least 400 m, as shown in Figure F4-5, to permit entering traffic to disperse into the through lanes. Additional length is warranted if the:

- ramp traffic volume is high,
- truck traffic on the freeway is heavy,
- roadway is on an upgrade, or
- the lane drop occurs at crest curve.

In the case of an auxiliary lane introduced before an exit, the lane should be extended as shown in Figure F4-5 to make full use of the capacity of the added lane.

F.4.5 Weaving

Where a freeway entrance is followed by an exit, the paths of traffic entering the freeway and that exiting the freeway, cross and are in conflict. This length of roadway is referred to as a "weaving section", and is an important consideration in the location of ramp terminals. If the frequency of lane changes is similar to that on an open highway, the section is said to be "out of the realm of weaving", but where they exceed the normal frequency of lane changes the condition is described as "weaving".

The conflict between entering and exiting traffic tends to interrupt the operation of normal through traffic, precipitates turbulence in traffic flow and has the effect of reducing service volumes and capacity.

Chapter B provides material on weaving calculations for level of service and capacity, for both simple weaving and multiple weaving. For a required level of service the minimum weaving length and number of lanes in the weaving section can be determined (see Figure F4-7). However, to maintain safe efficient operation on a weaving section on a freeway, the minimum weaving length between arterial interchanges is 600m and between an arterial interchange and a freeway interchange is 800 m. Shorter weaving lengths may be imposed due to other constraints and will operate with varying qualities of service depending on local conditions such as traffic volumes, sight distance and alignment features.

Weaving length is measured from a point where the adjacent edges of pavement at the merge are 0.5 m apart, to a point where adjacent edges of pavement at the diverge are 3.75 m apart.

Undesirable weaving conditions may be alleviated by increasing the number of lanes in the weaving section or increasing the length between successive entrance and exit bullnoses. If these measures are not effective or not feasible, it may be necessary to eliminate certain turning movements or relocate them elsewhere, in the interest of maintaining the operational integrity of the freeway. Alternatively, a weaving condition may be eliminated by separating the crossing traffic movements vertically by introducing a grade separation or basket weave type configuration. These solutions are illustrated in Figure F4-6.

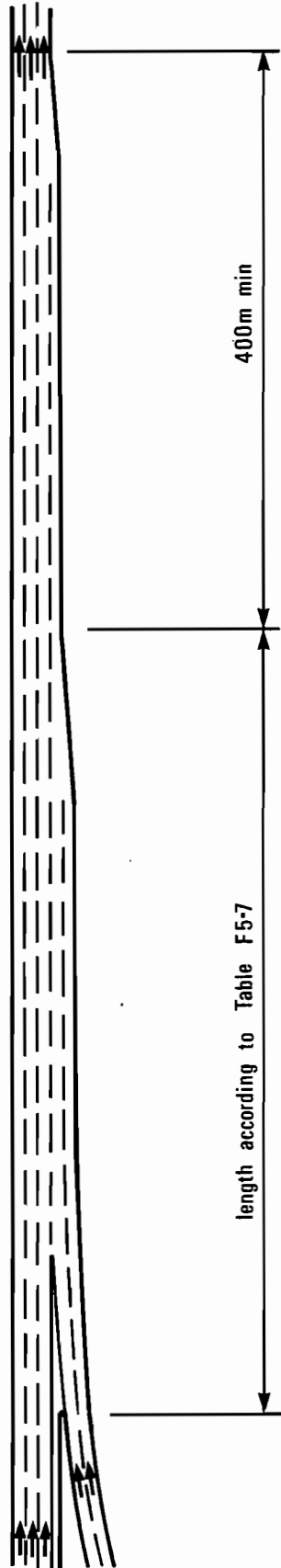

auxiliary lane extended beyond entrance

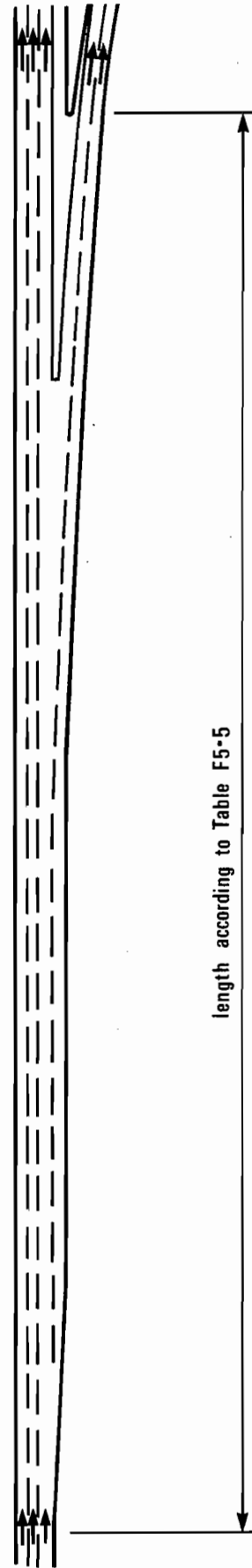

auxiliary lane introduced before an exit

Figure F4-5

Auxiliary Lanes

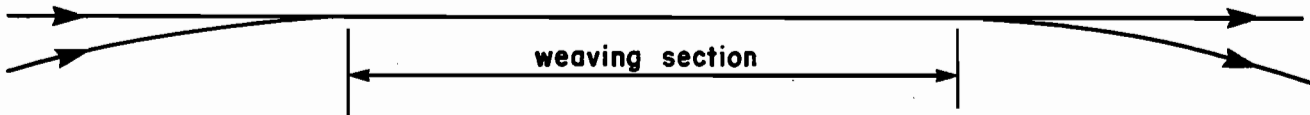
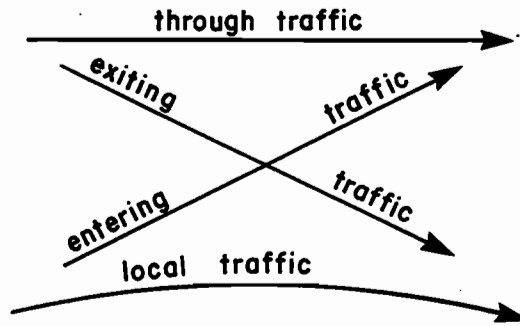
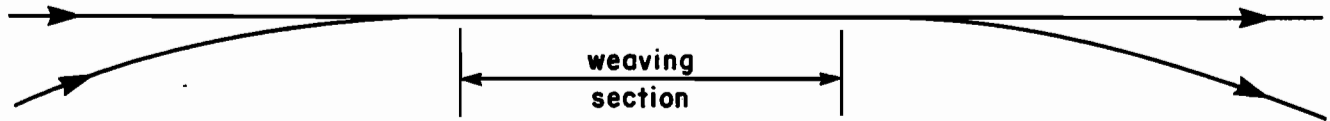

solution : increase length and/or number of lanes



solution : eliminate one of the turning movements and locate elsewhere

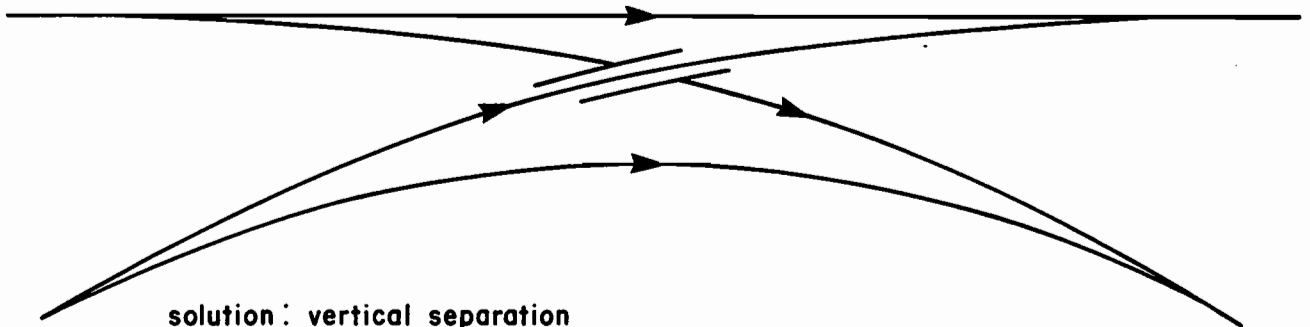

solution : vertical separation

Figure F4-6

Solutions to Undesirable Weaving

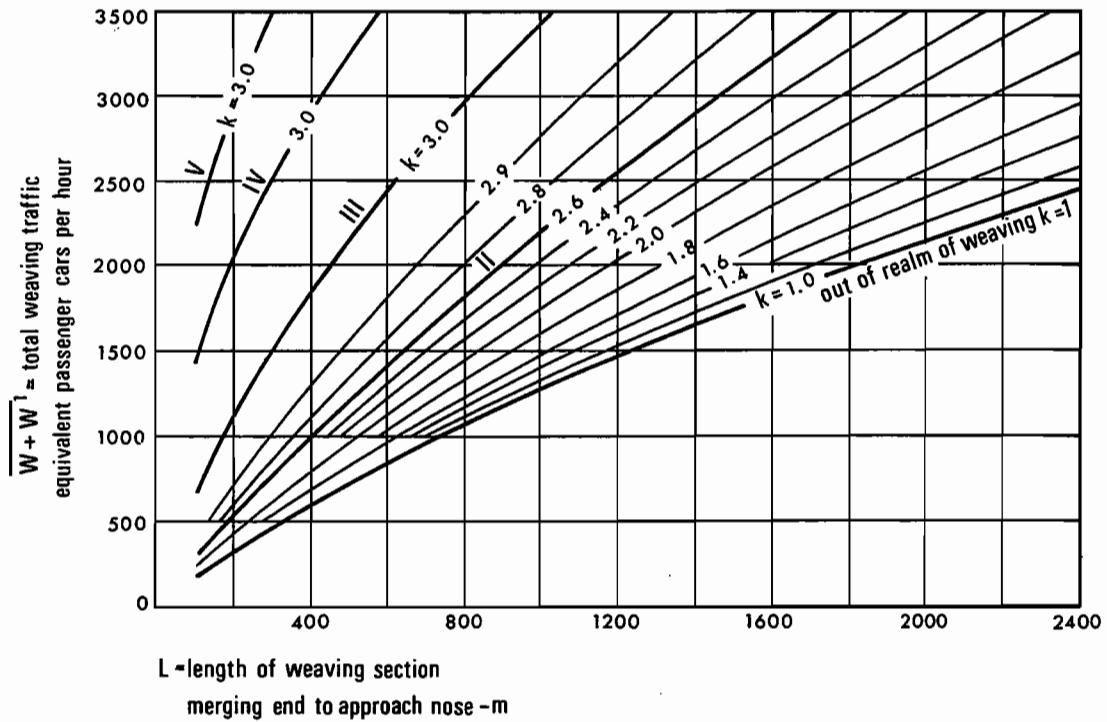

weaving factor k, may be derived from the chart

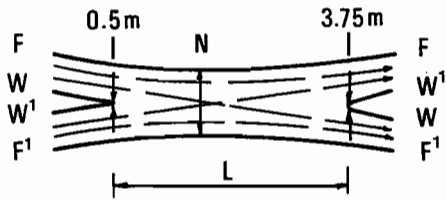

$$N = \frac{W + kW^1 + F + F^1}{SV}$$

$$N = \frac{V + (k-1)W^1}{SV}$$

- N - number of lanes
- W - larger weaving volume, v/h
- W¹ - smaller weaving volume, v/h
- F, F¹ - outer flows, v/h
- V - total volume, v/h
- k - weaving (intensity) factor
- SV - service volume or capacity per lane on approach and exit roadways, v/h
- W+W¹ - total weaving traffic equivalent passenger cars per hour

level of service for service volume, SV see table G.5a	weaving volume - length relation minimum design designated by chart curves	
	freeway proper	C-D roads & interchanges
A	I - II	II - III
B	II	III
C	II - III	III - IV
D	III - IV	IV
E	IV - V	V

Figure F4-7

Design Chart for Weaving

F.4.6 Lane and Route Continuity

In designing the lane arrangement on a freeway, design volume, maintenance of basic lanes and good land balance are all taken into account. A further consideration is that of lane continuity.

A driver needs to recognize which lanes are basic or through, to avoid being inadvertently led by the lane markings to an undesired ramp lane. If good lane balance is applied and basic lanes are maintained, together with all exits and entrances having a single lane on the right, lane continuity will naturally follow. Where entering and exiting ramps have two or more lanes, and at transfer lanes on collector roadways on express/collector systems (which are in effect left-hand exits and entrances), lane continuity might be lost.

Figure F4-8 illustrates examples of lane continuity. In illustration (i) three basic lanes are maintained, all ramps are single lane on the right and the principles of lane balance are observed. Lane continuity is maintained.

In illustration (ii) there are three basic lanes, all ramps are on the right and have two lanes, good lane balance is preserved and lane continuity is maintained.

In illustration (iii) there are two single-lane entrances on the right, a two-lane exit on the right, a two-lane (transfer) entrance on the left and a two-lane (transfer) exit on the left. Although three basic lanes are maintained through the section and the principles of lane balance are observed, only one of the basic lanes is continuous. This confuses the driver, causes turbulence and unnecessary

lane changing in the traffic operation, and is potentially hazardous.

Illustration (iv) shows how the deficiencies of illustration (iii) can be resolved. The number of lanes on each ramp and transfer roadway are the same, proper lane balance is observed and all three basic lanes are continuous. This is accomplished by use of auxiliary lanes on both the left and right-hand sides of the roadway.

Continuity of route designation, either by name or number, is important to reassure the driver that he is on his intended course, and this consideration influences the configuration of interchanges.

In Figure F4-9, two continuity arrangements are illustrated. In illustration (i) Highway 410 is a north-south route and 407 is an east-west route, in which case a conventional four level fully directional interchange is appropriate and the designated through route are consistent with the route numbers.

In illustration (ii), QEW is an east-south routes and Highway 403 is a north-west route. The through routes, and the route names and numbers, are maintained and the ramps carry traffic between route numbers. If the conventional configuration of illustration (i) were applied to the QEW/Highway 403 Interchange, the through route numbers would be carried on ramps. This would confuse a driver who expects to exit on a ramp (on the right) only when departing from the through route number to another route. The designated through route name or number, therefore influences the selection of the configuration of the interchange.

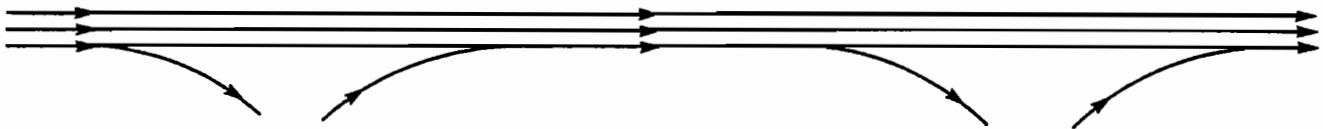

(i) three basic lanes, single lane ramps on the right
proper lane balance, lane continuity maintained

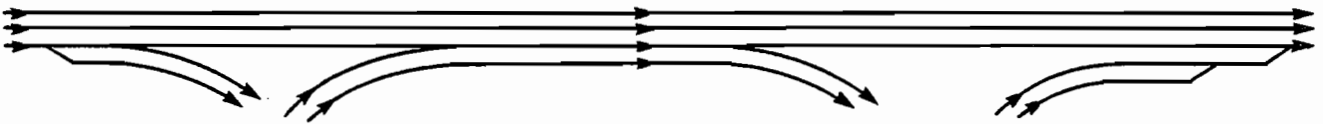

(ii) three basic lanes, two lane ramps on the right
proper lane balance, lane continuity maintained

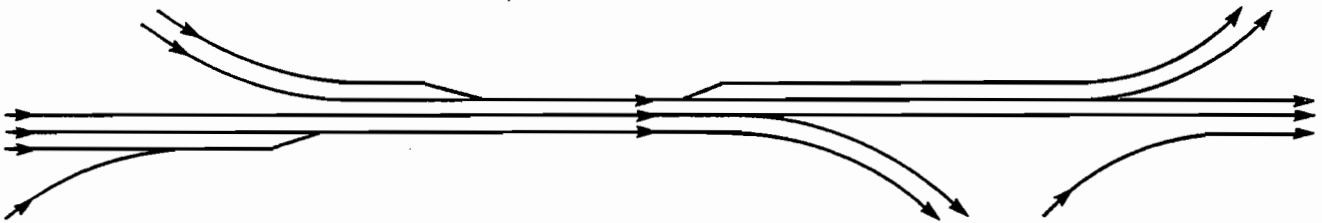

(iii) three basic lanes, proper lane balance but only one
through lane is continuous. lane continuity lost.

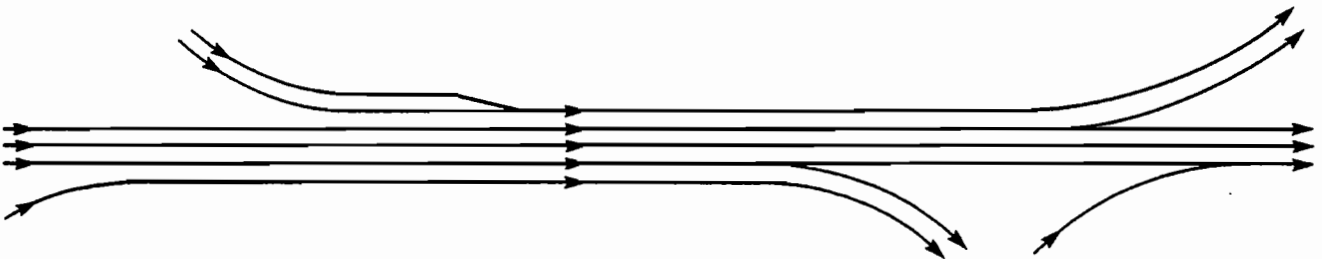

(iv) three basic lanes, proper lane balance. basic (through)
lanes are continuous. lane continuity is restored.

Figure F4-8

Lane Continuity

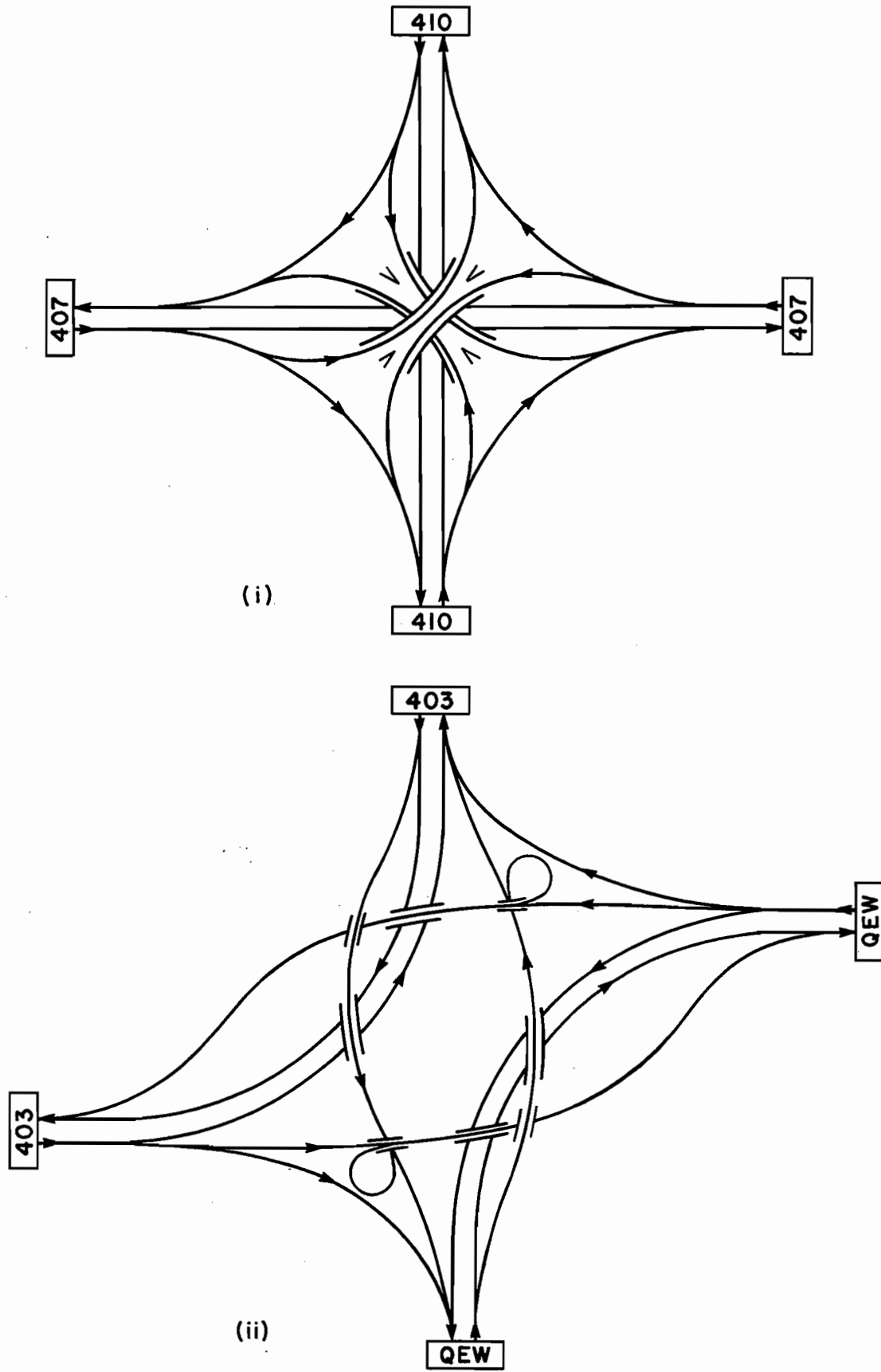
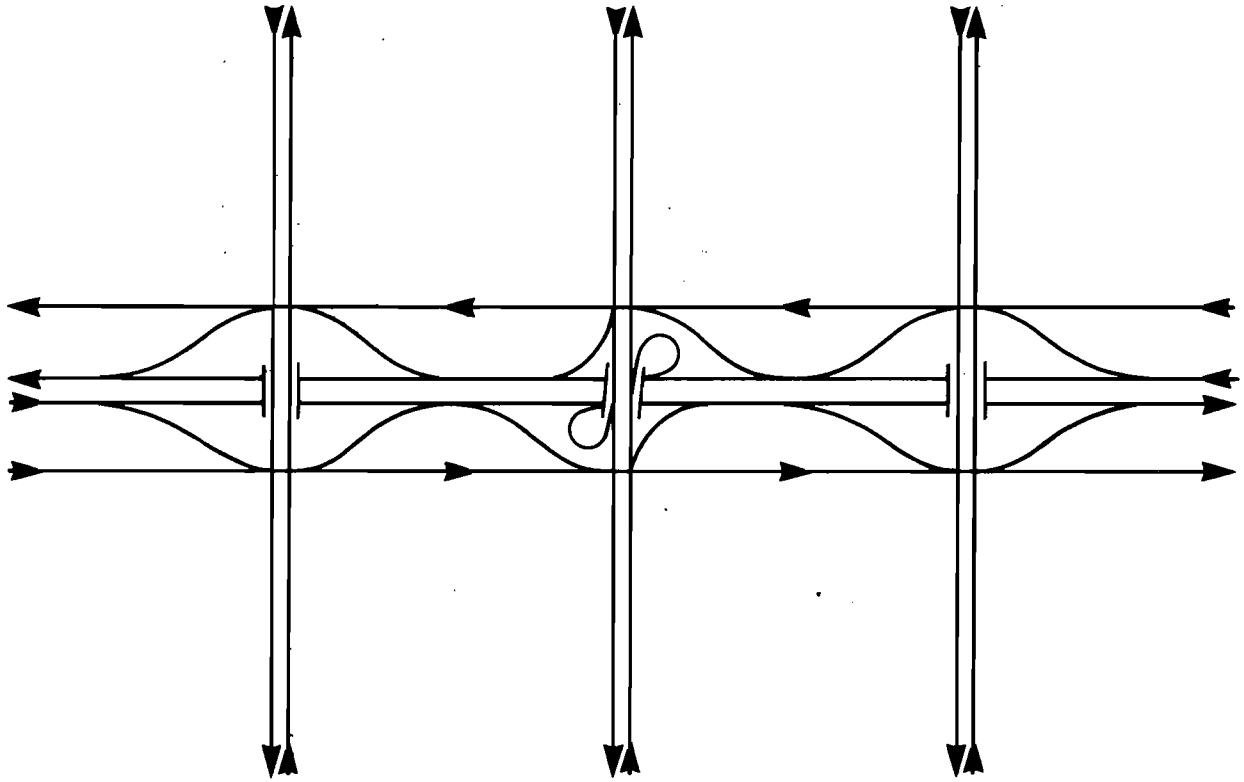
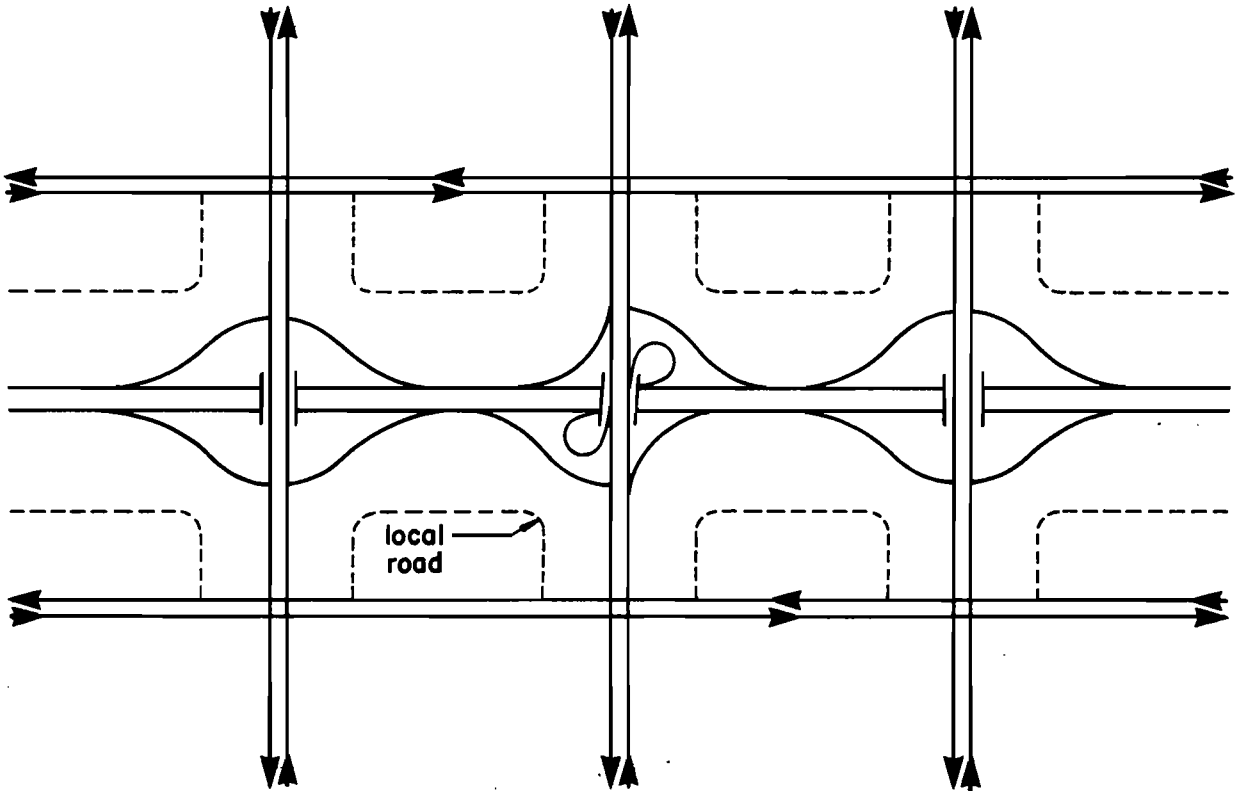

Figure F4-9
Route Continuity



(i) one-way service roads



(ii) two-way service roads

Figure F4-10

Freeway / Service Road Systems

F.4.7 Freeway/Service Road System

Service roads parallel to freeways, continuous for some distance, provide strong support to the freeway. They assist in the collection and distribution of traffic to and from the freeway, and provide flexibility to accommodate a variety of traffic patterns.

Parallel service roads are part of the arterial road system, intersecting with other arterial, collector and local roads through at grade intersections and provide limited access to major development. They are not to be confused with express-collector systems in which the collector lanes interchange with crossing arterial roads and have controlled access.

Parallel service roads can be either one-way or two-way, and each has its advantages and disadvantages.

Parallel one-way service roads may be located immediately adjacent to the freeway, with ramps transferring traffic between the freeway and the service road to distribute to and from the arterial crossing roads, as shown in Figure F4-10 illustration (i). In this way, part of the one-way service road functions as an element of the interchange system. Access to development on one-way service roads should be controlled, and avoided in the vicinity of merging and diverging ramp terminals. One-way service roads provide considerable flexibility for the freeway in that in the event of a bottleneck on the freeway, the service road can carry some or all of the through traffic until the bottleneck is cleared and through movement restored. One-way service roads have the disadvantage that traffic using them as an arterial road has longer return travel distance.

The weaving section between the end of the transfer lane on the service road and the subsequent intersection at the arterial road is critical to the successful operation of one-way service road systems. The transfer lane should be located so as to minimize this length without compromising the upstream weaving section on the freeway.

Two-way service roads located immediately adjacent to freeways should be avoided, since ramps intersection with two-way roadways tend to produce confusing and accident prone configurations. If ramps between freeways and adjacent two-way service roads are avoided in favour of conventional interchanges at crossing arterial roads, the intersection of the parallel service road with the crossing arterial usually provides undesirable short intersection distance on the arterial road.

The most suitable location for parallel two-way service roads is some distance away from the freeway with conventional interchanges between the freeway and crossing arterial roads, shown in Figure F4-10 illustration (ii). The two-way service road should be located so that adequate intersection distance is provided on the crossing road between the interchange ramp terminals and service road. This distance depends on the traffic characteristics and design of the crossing road. Consideration should also be given to the appropriate distance between the freeway and service roads, from a planning point of view, if the system is for a newly developing area.

F.4.8 Express/Collector Systems

If more than four basic lanes in each direction of a freeway are required on the basis of traffic volume, two roadways in each direction are normally introduced. The inner roadways are referred to as express lanes and the outer roadways as collector lanes. Collector lanes, like the express lanes, are fully-controlled access, grade separated at crossing roads, with ingress and egress to and from arterial roads through interchanges. Access between the express lanes and collector lanes is provided through transfer roadway crossing the outer separations. Figure F4-11 illustrates a typical express/collector system.

Traffic entering the express-collector system from the arterial road system does so by means of an interchange to the collector lanes, and may transfer to the express lanes. Traffic wishing to exit from the express lanes does so by a transfer roadway to the collector road before the required interchange, and then proceeds through the interchange to the arterial road system. Traffic travelling relatively short distances on the freeway remains on the collector road throughout.

Collector roadways differ only from conventional freeway roadways in that they have left exits and entrances to transfer lanes. Design speed and other geometric design features are the same.

An interchange at the express-collector system crossing another freeway will normally provide ramps for all movements between the collector roadways and the crossing freeway. In addition, a limited number of movements between the express lanes and the crossing freeway may be provided. These allow traffic to move directly between the crossing freeway and the express lanes, and assist in minimizing weaving conditions on the collector roads.

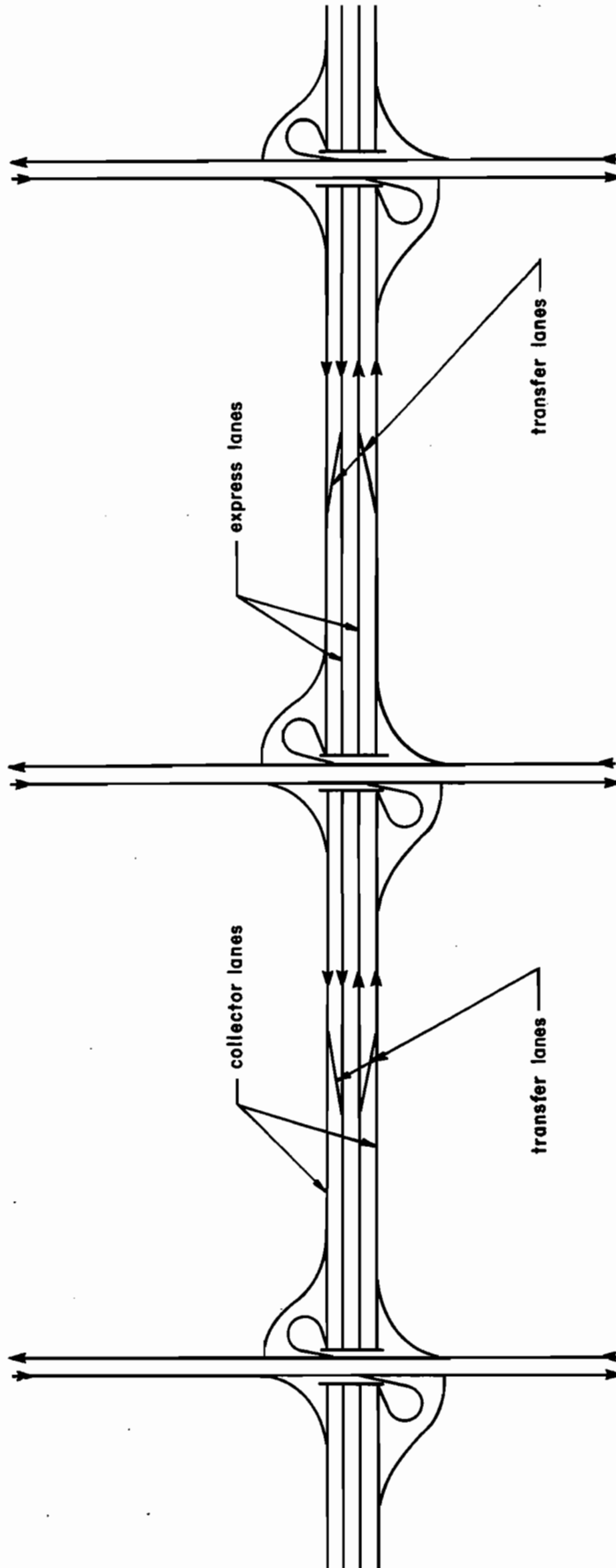

Figure F4-11

Express / Collector System

F.5 INTERCHANGE RAMPS

F.5.1 GENERAL

A ramp is a connecting roadway, usually one way, carrying traffic between two grade-separated through roadways. Except in special and unusual circumstances, ramps are fully access-controlled and no access is permitted to other roadways or development.

Ramp design is broken down into three elements, namely, the exit terminal, the roadway or ramp between the two bullnoses, and the entrance terminal illustrated in Figure F5-1. The location of the two bullnoses is dependent on the geometric features of the two roadways and the desired characteristics of the ramp.

Ramps may have one, two or three lanes. Ramps on rural interchanges normally have one lane. Ramps for traffic entering freeways in urban areas normally have one lane and ramps for traffic exiting freeways in urban areas normally have two lanes and on occasions, three lanes, where there is a change in the number of basic lanes of the freeway.

In ramp capacity analysis, the three components are examined separately and the lowest of the three is regarded as the capacity or service volume. Normally this is at an exit or entrance terminal on the freeway or in the case of an intersection terminal, at the intersection. Chapter B, Traffic and Capacity should be referred to for procedures for ramp capacity analysis.

POLICY

FOR A NUMBER OF REASONS, DISCUSSED IN SECTION F.3.2, RIGHT EXIT AND ENTRANCE TERMINALS ARE PREFERRED ON FREEWAYS AND IN GENERAL, ON ARTERIAL ROADS.

In the following sections, F.5.3, F.5.4 and F.5.6, the discussion refers to right exits and entrances, but applies equally to left exits and entrances. From a design standpoint, a left terminal is essentially a mirror image of a right terminal.

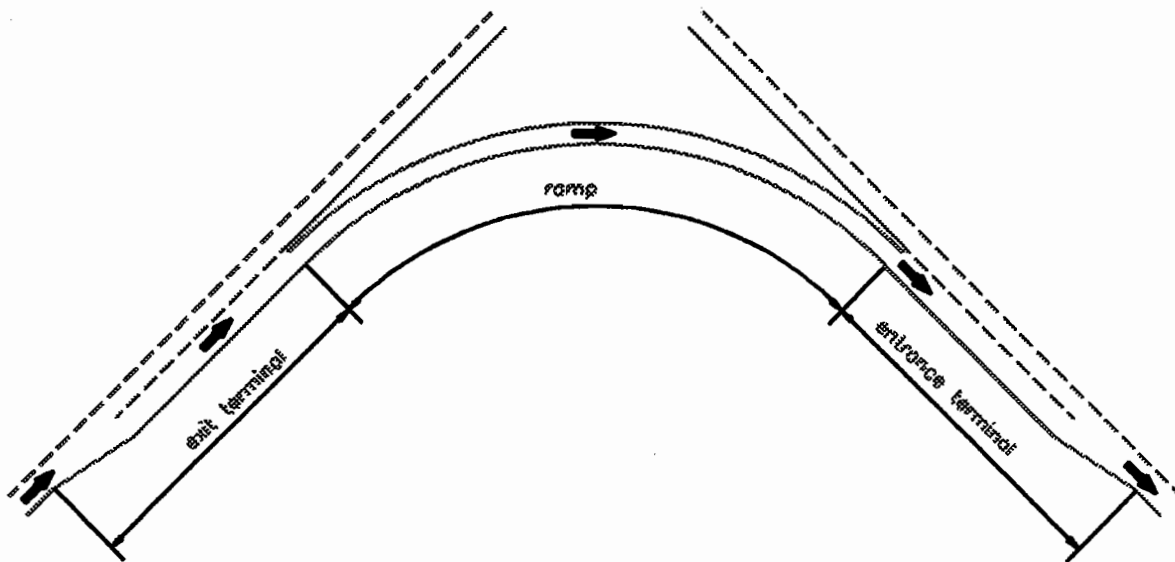

Figure F5-1

Ramp Design Elements

F.5.2 DESIGN CONSIDERATIONS

F.5.2.1 Ramp Geometry

The general configuration of an interchange ramp is determined when the interchange type is selected. The geometric features of the alignment, profile and cross section, are influenced by a number of design considerations such as traffic volume and traffic mix, geometric and operational characteristics of the adjacent through roadways, terrain, traffic control devices and driver expectation, all of which are taken into account in the geometric design and detailing of the interchange ramps.

Interchange ramps carrying traffic either from or to a freeway are regarded as freeway in character and have the same physical and operational features such as limited access, no stopping, and provision of a shoulder for emergency purposes. Ramps between two arterial roads or an arterial road and a collector road may have a sidewalk or shoulder. Ramp lane widths are discussed in Chapter D, Section D.2.4.

POLICY

MAXIMUM RATE OF SUPERELEVATION FOR INTERCHANGE RAMP ON URBAN FREEWAYS WHERE A HIGH LEVEL OF MAINTENANCE PREVAILS AND LITTLE ACCUMULATION OF SNOW AND ICE IS ANTICIPATED IS 0.08 M/M. FOR ALL OTHER INTERCHANGE RAMP, MAXIMUM SUPERELEVATION IS 0.06 M/M.

F.5.2.2 Design Speed

It is rarely feasible to provide ramps in the same range of speeds as on the through roads, but it is desirable that drivers be able to use ramps at as high a speed as practicable so that there will be little conscious effort required in a decrease from or an increase to the speed of through traffic. The design speed of the ramp, therefore, is related to the design speed of the intersecting roads.

The view of a structure, its ramps and approach signing encourage drivers to slow down. Most drivers are willing to reduce speed if the reduction is not excessive, and if they can traverse the ramp at reasonable speed.

Guide values for ramp design speed in terms of highway design speed are shown in Table F5-1. To cover the wide variety of interchange types and site

conditions the ramp design speed is shown as a range between standard and minimum. Ramp designs are based on the standard design speeds where feasible. Where ramps so designed are out of balance with the interchange or are unduly costly, a lower design speed is appropriate. Selection of ramp design speed depends upon the type of intersecting roads and the site controls.

For outer loops and direct ramps from crossing roads, the standard values of design speed given in table F5-1 are used.

For inner loops, standard values of design speed given in Table F5-1 are not attainable, because of the large areas required.

For inner loops from a crossing road exit terminal the minimum values are:

- Parclo A inner loop - urban condition

Crossing road design speed	60 - 80 km/h
Ramp design speed	40 km/h
Superelevation e_{max}	0.08 m/m
Minimum radius	50 m

When truck volumes are <500 per day the radius can be reduced to 45 m.

For inner loops from a highway exit terminal the minimum values are:

- Parclo B inner loop - urban condition

Highway design speed	100 km/h
Ramp design speed	50 km/h
Superelevation e_{max}	0.08 m/m
Minimum radius	80 m

F.5.2.3 Sight distance

Maintaining stopping sight distance, as discussed in Chapter C, Section C.2.3 and measured using the criteria discussed in Sections C.3.4.1, C.4.3.4, and C.4.3.5 is regarded as the minimum requirement for ramp design. A driver travelling between roadways through an interchange is carrying out complex manoeuvres, and the additional sight distance discussed in Section F.5.3.6 is desirable throughout the length of the ramp, and the terminals. To determine the sight distances graphically refer to Section C.6.

Table F5-1

RAMP DESIGN SPEED

Highway Design Speed km/h	50	60	70	80	90	100	110	120
Ramp Design Speed, km/h								
standard	40	50	50	60	70	70	80	80
minimum	30	40	40	40	50	50	60	60
$e_{max} = 0.08$ m/m								
minimum radius, m								
standard	50	80	80	120	170	170	230	230
minimum	30	50	50	50	80	80	120	120
$e_{max} = 0.06$ m/m								
minimum radius, m								
standard	55	90	90	130	190	190	250	250
minimum	30	55	55	55	90	90	130	130

F.5.3 EXIT TERMINALS

Exit terminal refers to the transition area of a roadway between the through lanes of a road and a ramp, to facilitate traffic moving from a through lane to a ramp. Two forms of terminals are used, namely "parallel" and "direct", illustrated in Figures F5-2(i),(ii) and (iii). Applications of both are described in the following sections.

The design speed for the exit terminal design is taken to be the same as that for the through roadway, since the terminal is intended to allow traffic to travel at or close to through traffic speeds.

Designs for exit terminals are shown in Figures FA-1 to FA-4, in the Appendix to the Chapter. These designs should be regarded as typical rather than standard, and are for the guidance of the designer. Rigid adherence to these designs may produce unsatisfactory operation in some cases. Dimensions are typical and variations are required to suit local conditions of alignment, grade, profile, traffic volume, traffic mix and local physical and environmental features. Nor are the designs necessarily complete in every detail, and additional detailing may be required.

F.5.3.1 Single-Lane Exits

For single-lane exit terminals, both the parallel lane designs and direct taper designs are used. An alternative to the direct taper design is the direct spiral design used when local conditions warrant.

In the parallel lane design, illustrated in Figure F5-2(i), a short length of taper is applied to develop a lane of constant width for some distance, gradually widening to the bullnose. An exiting vehicle is intended to move into the parallel lane without reduction of speed and then to decelerate steadily to the bullnose. In this way, the exiting manoeuvre does not impede the flow of through traffic.

In the direct taper design, illustrated in Figure F5-2(ii), the right edge of the terminal has tangent configuration, gradually widening the roadway from the beginning of the terminal to the bullnose. The taper is designed so that a vehicle exiting and following the direct taper alignment is encouraged to begin deceleration only when the vehicle is entirely on the exit terminal lane, so as to avoid impeding the travel of through traffic.

INTERCHANGES

In the direct spiral design, illustrated in Figure F5-2(iii), the right edge of the terminal has spiral configuration, gradually widening the roadway from the beginning of the terminal to the bullnose. It is important that the decelerating vehicle not impede the travel of through traffic and yet is still able to decelerate to the ramp design speed.

This design is used in urban areas where there is a minimum of three lanes in each direction on the crossing road and its design speed is 60 km/h or less.

INTERCHANGE RAMPS

On crossing roads, the direct spiral form of exit terminal design is used for through road design speeds up to 60 km/h, the direct taper form is used for through road design speeds up to 100 km/h, and the parallel form is used for higher design speeds. Typical designs are shown in Figure FA-1 located in the appendix to the chapter.

On freeways the parallel form of exit terminal design is used for all design speeds. Typical designs are shown in Figure FA-2, in the appendix to the chapter.

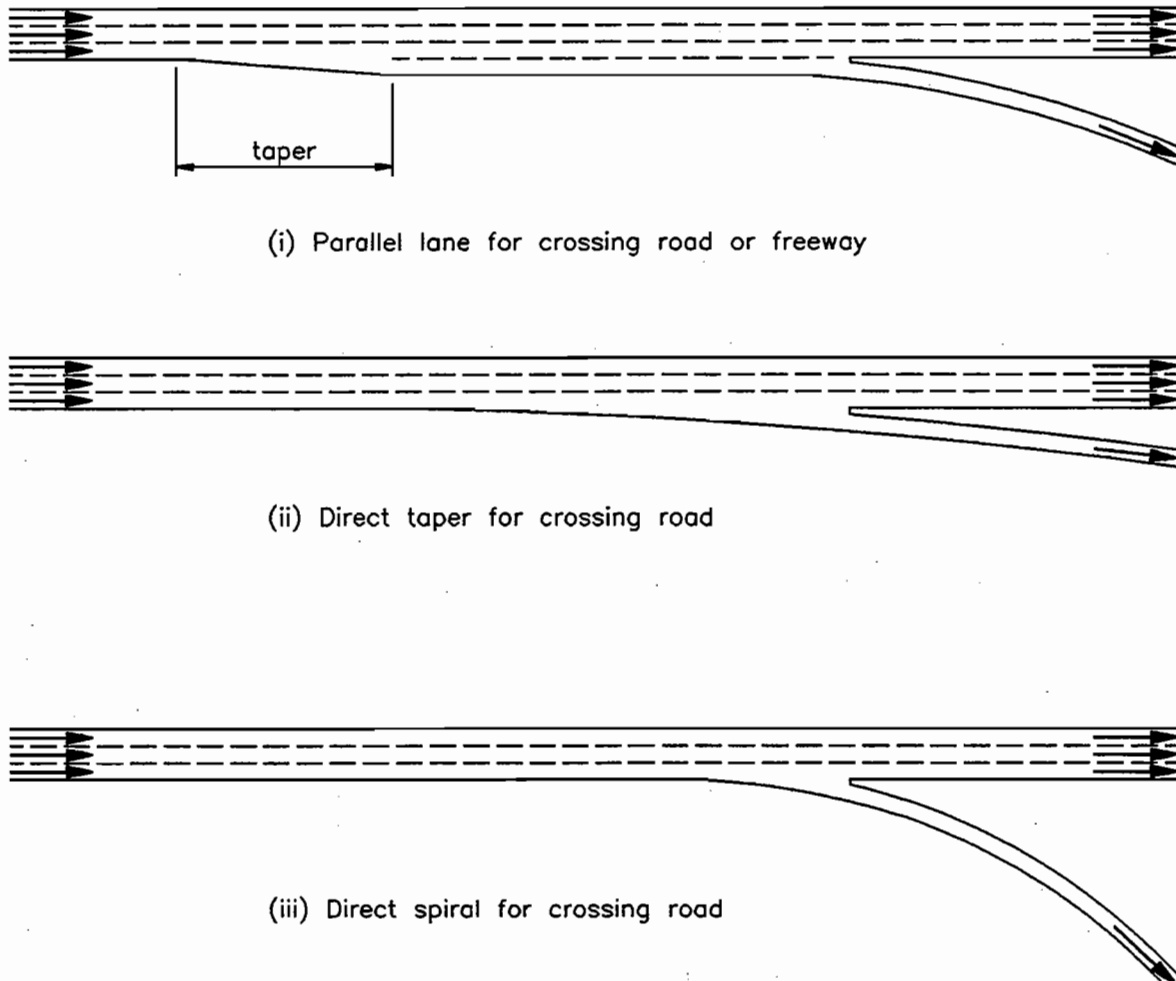

Figure F5-2
Single-Lane Exit Terminal Configuration

F.5.3.2 Two-Lane Exits

In a two-lane exit terminal design on a freeway where the principles of lane balance and maintenance of a basic lanes are maintained, the number of lanes upstream of the terminal is equal to the basic number of lanes plus one. The additional lane is an auxiliary lane which may have been added to maintain lane balance for a two-lane exit, or as an auxiliary lane carried from a previous entrance terminal, illustrated in figure F5-3 (i) and (ii).

The normal lane arrangement for this form of terminal is to make the auxiliary lane continuous with the right-

hand lane of the ramp and the adjacent basic lane continuous with the first basic lane downstream on the through roadway and also continuous with the left lane of the ramp. With this arrangement, traffic in the auxiliary lane (also known as a "must exit" lane) is required to take the exit and traffic in the first basic lane (also known as a "either / or" lane) has the choice of continuing through on the same lane or continuing into the left lane of the ramp.

Typical designs are shown in Figures FA-3 and FA-4 for design speeds of 110 km/h and 120 km/h, located in the appendix to the chapter.

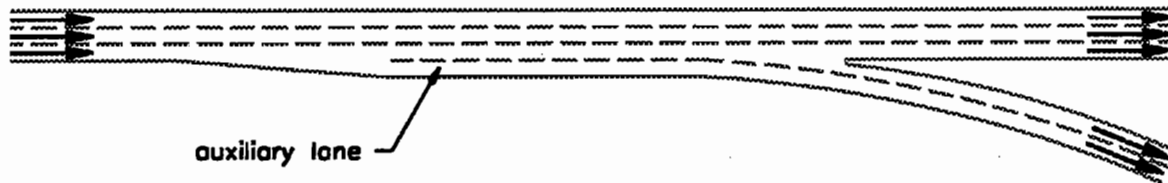

(i) Auxiliary lane added upstream

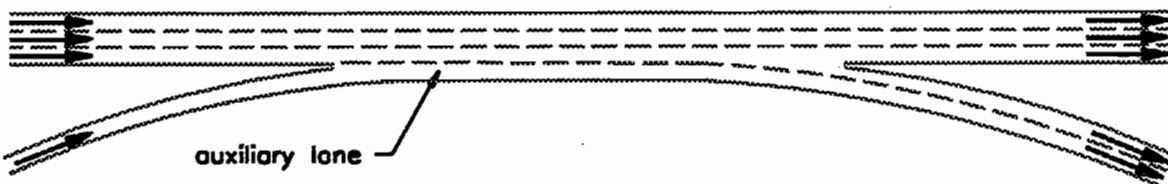

(ii) Auxiliary lane carried from previous entrance

Figure F5-3

Two-Lane Freeway Exit Terminal Configuration

F.5.3.3 Three-Lane Exits

Three-lane exits are sometimes applied at a freeway-to-freeway interchange where there is a reduction in the number of basic lanes. The design of a three-lane exit terminal is identical to that of a two-lane exit with an additional lane to the right (looking in the direction of travel). Usually the right lane is an auxiliary lane and the adjacent lane is a basic lane to be dropped at the interchange, illustrated in Figure F5-4, (i) and (ii).

F.5.3.4 Major Fork

A major fork occurs where a freeway terminates at a crossing freeway. In effect there is a left exit ramp and a right exit ramp with no through movement. For signing both ramps have route numbers or names different from those upstream. The driver tends to feel both ramps have the characteristics of a through road, and as high a design speed as possible should be assigned to them. A design for a major fork is illustrated in Figure FA-8 in the appendix.

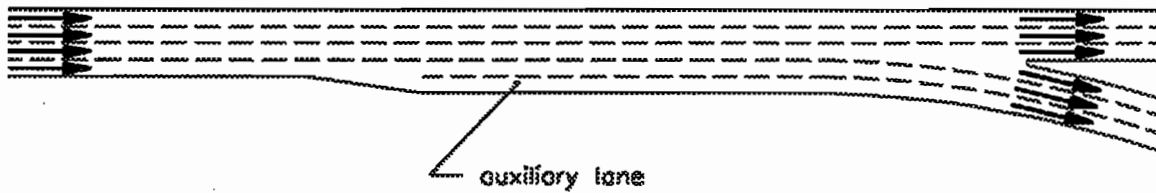

(i) Auxiliary lane added upstream

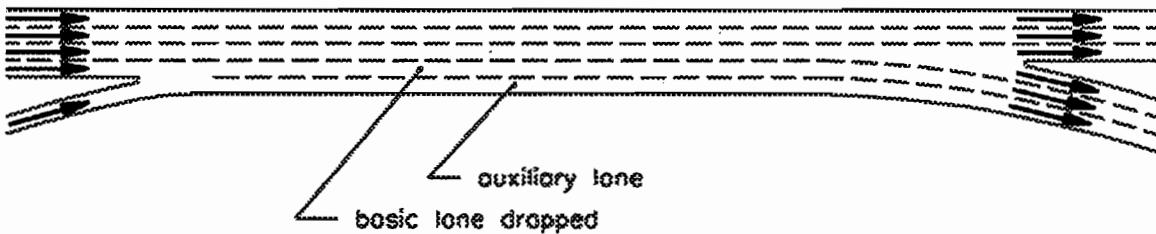

(ii) Auxiliary lane carried from previous entrance

Figure F5-4

Three-Lane Freeway Exit Terminal Configuration

F.5.3.5 Exit Terminal Bullnoses

Bullnoses for exit terminals may include or exclude curb and gutter. If curb and gutter is omitted, the bullnose is squared off and if it is included the bullnose is rounded. Dimensions are shown in Figure F5-5 and in Figures FA-1 to FA-4 for both designs.

The exit bullnose is the decision point area that must be clearly seen and understood by the approaching driver.

Accident rates in the vicinity of bullnoses are higher than at other locations and for this reason the bullnose is usually offset from through traffic to provide a recovery area for errant vehicles.

Bullnose areas normally consist of pavement only, without curb, unless drainage considerations indicate benefit from the use of curb.

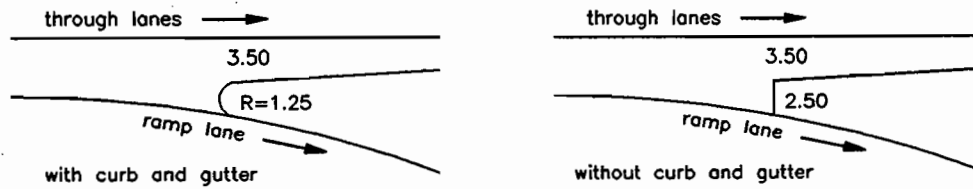

(i) Single lane freeway exit

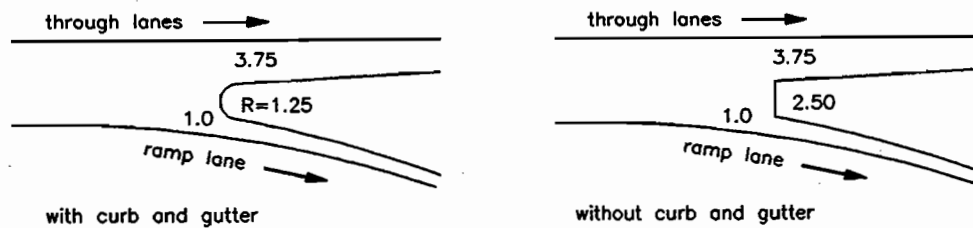

(ii) Two-lane freeway exit

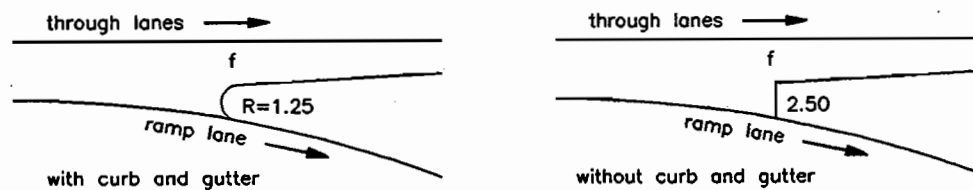

(iii) Single-lane crossing road exit

Design Speed km/h	50	60	70	80	90	100	110	120
Bullnose Offset f (m)	1.0	1.2	1.4	1.6	1.8	2.0	2.2	2.4

Figure F5-5
Exit Terminal Bullnose and Offset Dimensions

F.5.3.6 Sight Distance at Exit Terminals

It is important that a driver approaching an exit terminal, particularly on a freeway, see the bullnose in sufficient time to make appropriate adjustments in speed and manoeuvre into the speed change lane safely and without disrupting through traffic. Providing minimum stopping sight distance for the design speed, as shown in Chapter C, Section C.2.3 is inadequate since minimum stopping sight distance is predicated on a driver making an emergency stop in rare and surprised conditions. Traffic preparing to make an exit manoeuvre is a frequent occurrence and calls for different criteria.

Sight distance, greater than minimum stopping sight distance, is required for the driver to make a series of decisions and execute the manoeuvre safely. Table F5-2 shows sight distance to the bullnose for a range of design speeds. It is desirable for the driver to see the pavement surface at the bullnose from a distance at least equal to this sight distance, illustrated in Figure F5-6. Ideally the driver should have a view of the pavement surface of part of the ramp beyond the bullnose. A range of values is shown in the table to reflect the variation in complexity of different cases. In general, rural conditions are less complex and therefore the lower values are adequate, but urban conditions present a variety of complexities and higher values should be used.

Table F5-2

SIGHT DISTANCE AT EXIT TERMINALS

Design Speed km/h	60	70	80	90	100	110	120
Sight Distance to Bullnose, m	170 to 230	200 to 270	240 to 310	270 to 350	300 to 390	340 to 430	370 to 470

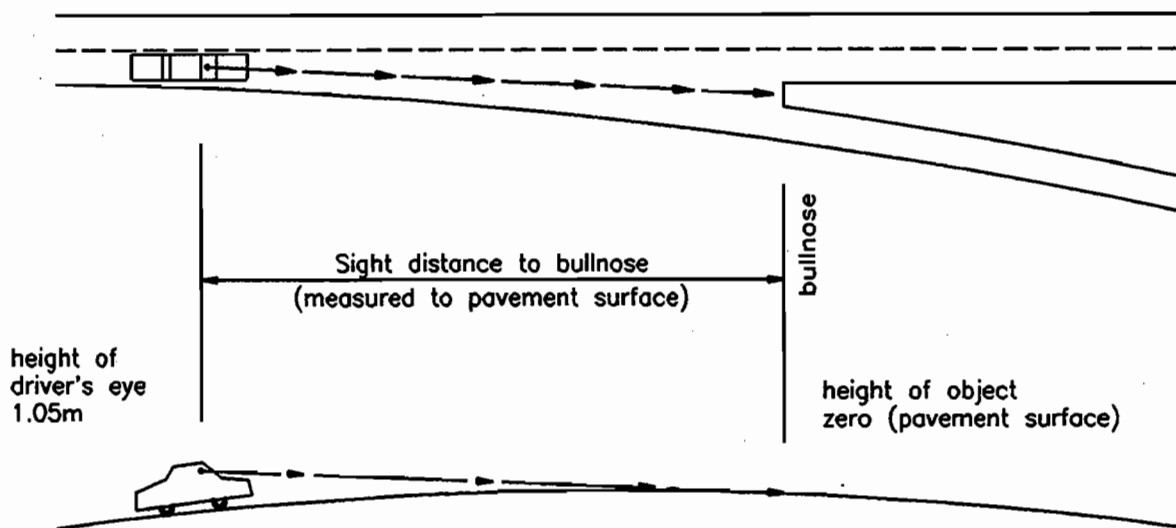

Figure F5-6

Sight Distance at Exit Terminals

F.5.3.7 Design Lengths for Exit Terminal Speed-Change Lanes

Drivers leaving a highway at an interchange are required to reduce speed as they exit to a ramp. Because the change in speed is usually substantial, provision should be made for deceleration to be accomplished on auxiliary lanes to minimize interference with through traffic and to reduce accident potential. Such an auxiliary lane, including tapered areas, primarily for the deceleration of vehicles entering or leaving the through-traffic lanes is called a speed-change lane. The term speed-change lane or deceleration lane, applies to the added pavement adjoining the travelled way of the highway and does not necessarily imply a lane of uniform width.

A speed-change lane should have sufficient length to enable a driver to decelerate in a safe and comfortable manner.

The length of a deceleration lane is based on three factors in combination, namely:

- the speed at which drivers manoeuvre into the deceleration lane,
- the speed at the bullnose, and
- the manner of decelerating.

For crossing roads it is assumed that drivers travel at the assumed speed* at the beginning of the speed-change lane. For design speeds of 50 km/h to 80 km/h (normally urban conditions) it is assumed that the vehicle travels for 2 s in gear followed by comfortable braking to 40 km/h at the bullnose. For design speeds above 80 km/h it is assumed that the vehicle travels for 2 s in gear followed by leisurely braking to 50 km/h at the bullnose.

For single-lane freeway exit terminals (which have parallel speed-change lanes) the length of taper is equal to the distance travelled at the assumed speed in 3 s. Having travelled the taper at the assumed speed the vehicle is assumed to decelerate in gear for 4 s and then under leisurely braking, slow to a speed of 50 km/h at the bullnose.

For two-lane freeway exit terminals, the length is based on a different concept, whereby the exit curve to the bullnose is considered to govern the manoeuvre of the vehicle exiting to the left-hand of the two lanes. This lane configuration has been based on deceleration in gear for 3 s at the assumed speed followed by comfortable braking to 50 km/h at the bullnose, with deceleration commencing at the point where a half lane width is available to the vehicle exiting to the left lane. For two-lane freeway exit terminals the total length is based on the vehicle exiting to the right lane of the two lanes, utilizing a 3 s lane shift taper at the assumed speed plus deceleration in gear to a speed of 50 km/h at the bullnose.

Distance travelled during deceleration in gear and under braking are shown in Figure F5-7. Examples of the determination for the design lengths of speed-change lanes are shown on page F5-11. Tables F5-3, F5-4 and F5-5 show design values for length of deceleration lanes, and their method of measurement. For the parallel form the values in the table include the length of taper. For the direct taper form the values shown refer to the length from the beginning of taper to the bullnose.

Where deceleration lanes are on grades steeper than 2%, the length shown in the tables should be adjusted by the appropriate factor in Table F5-6.

* See Chapter C, Section C.2.3.1 and Table C2-1

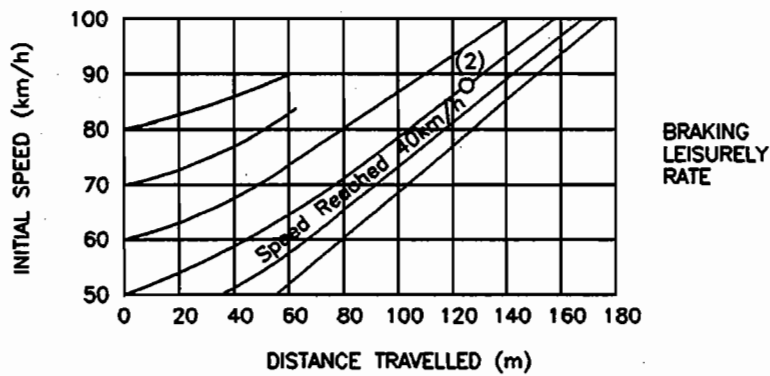
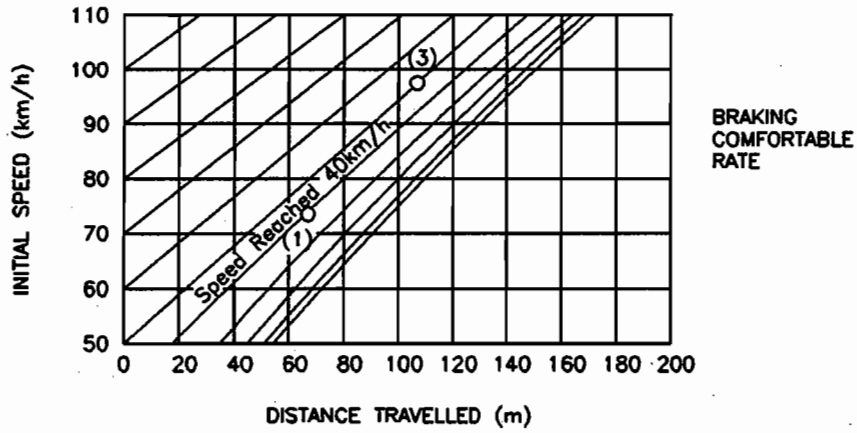
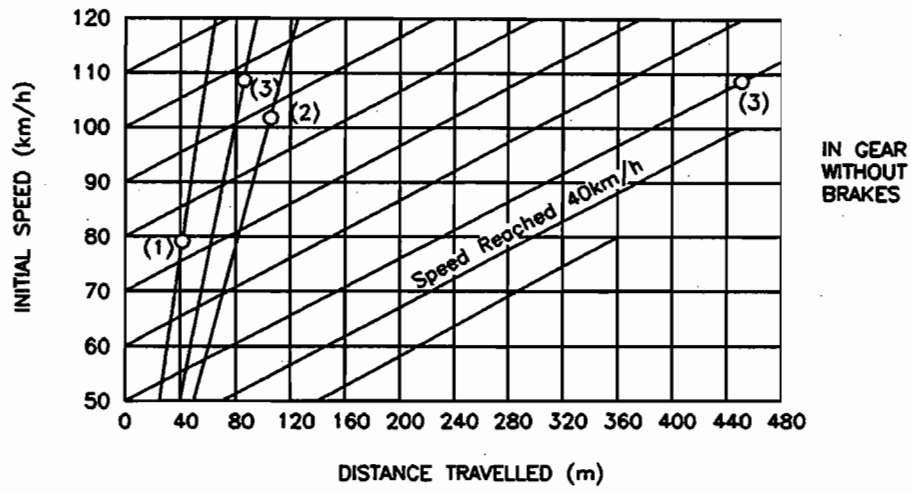

Figure F5-7
Distance Travelled During Deceleration

EXAMPLES OF DETERMINATION FOR DESIGN LENGTH OF SPEED-CHANGE LANES**Example 1:** Exit Terminal on Crossing Road at 80 km/h Design Speed

42 m required to decelerate for 2 s in gear from an assumed speed of 79 km/h to a "speed reached" of 73 km/h;

67 m required to decelerate at a comfortable rate from a speed of 73 km/h to 40 km/h at the bullnose.

The total length of 109 m is required; the standard length of 110 m is adopted.

Example 2: Exit Terminal on Freeway for Single-Lane Ramp at 110 km/h Design Speed

105 m required to decelerate for 4 s in gear from an assumed speed of 102 km/h to a "speed reached" of 88 km/h;

125 m required to decelerate at a leisurely rate from a speed of 88 km/h to 50 km/h at the bullnose.

The total length of 230 m is required; the standard length of 315 m, including a 3 s taper at the assumed speed is adopted.

Example 3: Exit Terminal on Freeway for Two-Lane Ramp at 120 km/h Design Speed

(i) Left Lane

86 m required to decelerate for 3 s in gear from an assumed speed of 109 km/h to a "speed reached" of 97 km/h;

105 m required to decelerate at a comfortable rate from a speed of 97 km/h to 50 km/h at the bullnose.

The total length of 191 m is required for the length of the left lane from half lane width to the bullnose.

(ii) Right Lane

445 m required to decelerate in gear from an assumed speed of 109 km/h to 50 km/h at the bullnose.

The standard length of 535 m, including a 3 s taper at the assumed speed is adopted.

Table F5-3

LENGTH OF SPEED-CHANGE LANES AT EXIT TERMINALS ON CROSSING ROADS

Design Speed of Crossing Road, km/h	50	60	70	80	90	100	110
Speed at bullnose, km/h	40	40	40	40	50	50	50
Length of Speed-Change Lane*, m	60	60	85	110	150	180	200
Length of taper, m	-	-	-	-	-	-	85

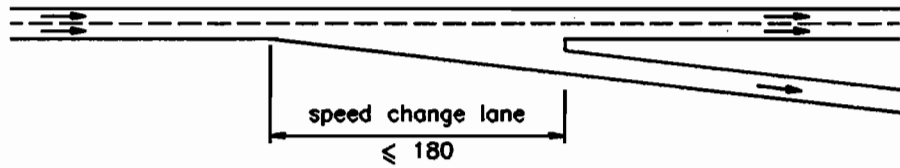

(i) Direct taper on exit terminal

Table F5-4

LENGTH OF SPEED-CHANGE LANES AT EXIT TERMINALS ON FREEWAYS FOR SINGLE-LANE RAMPS

Design Speed of Freeway, km/h	100	110	120
Speed at bullnose, km/h	50	50	50
Length of Speed-Change Lane including taper, m	290	315	345
Length of taper, m	80	85	90

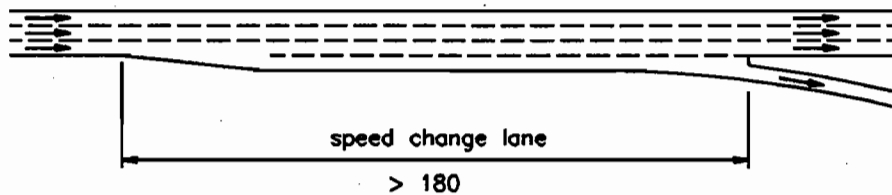

(i) Single-lane parallel exit terminal

Table F5-5

LENGTH OF SPEED-CHANGE LANES AT EXIT TERMINALS ON FREEWAYS FOR TWO-LANE RAMPS

Design Speed of Freeway, km/h	110	120
Speed at bullnose, km/h	50	50
Length of Speed-Change Lane including taper, m	480	535
Length of taper, m	85	90

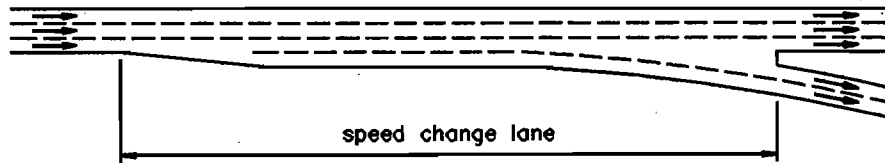

(i) Two-lane exit terminal

Table F5-6

GRADE FACTORS FOR EXIT SPEED-CHANGE LANES

	DOWN GRADE %	GRADE FACTOR > 1	UP GRADE %	GRADE FACTOR ≤ 1
ALL	8-7	1.5	2-3	1.0
DESIGN	7-6	1.4	3-4	0.9
SPEEDS	6-5	1.4	4-5	0.9
km/h	5-4	1.3	5-6	0.8
	4-3	1.2	6-7	0.8
	3-2	1.1	7-8	0.7

F.5.4 ENTRANCE TERMINALS

Entrance terminal refers to the transition area of a roadway between the through lanes of a road and a ramp, to facilitate traffic moving from a ramp to a through lane. Two forms of terminal are used, namely "parallel" and "direct", illustrated in figure F5-8 (i) and (ii). Applications of both are described in the following sections.

The design speed for entrance terminal design is taken to be the same as that for the through roadway, since the terminal is intended to encourage traffic to travel at or close to through traffic speeds.

Designs for entrance terminals are shown in figures FA-5 to FA-7, in the Appendix to the Chapter. These designs should be regarded as typical rather than standard, and are for the guidance of the designer. Rigid adherence to these designs may produce unsatisfactory operation in some cases. Dimensions are typical and variations are required to suit local conditions of alignment, grade, profile, traffic volume, traffic mix and local physical and environmental features. Nor are the designs necessarily complete in every detail, and additional detailing may be required.

Some ramps intersect with crossing roads at the downstream end of the ramp in at-grade intersections. For design of such intersections, reference should be made to Chapter E, Intersections, and examples are given in Figures FA-9 to FA-13.

F.5.4.1 Single-Lane Entrances

Single-lane entrance terminals may be either parallel lane design or direct taper design.

In the parallel lane design, illustrated in Figure F5-8 (i) an auxiliary lane to the right of the through lane is discontinued by means of a taper, some distance downstream. The driver entering on a parallel lane is intended to accelerate to through traffic speed, or close to it, on the parallel section of the terminal before making a lane change into the adjacent through lane.

The direct taper design illustrated in Figure F5-8 (ii), follows a direct tangent alignment from the entrance bullnose to the edge of the through lane some distance downstream, allowing a vehicle to accelerate close to the through travel speed before beginning to encroach on the adjacent through lane.

On crossing roads, the direct taper form of entrance terminal is used for through road design speeds up to 80 km/h, and the parallel form is used for higher design speeds. Typical designs are shown in Figure FA-5 located in the Appendix to the Chapter.

On freeways the parallel form of entrance terminal design is used for all design speeds. Typical designs are shown in Figure FA-6 located in the Appendix to the Chapter.

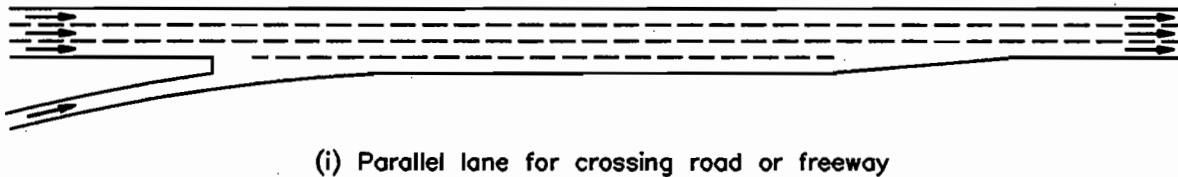

(i) Parallel lane for crossing road or freeway

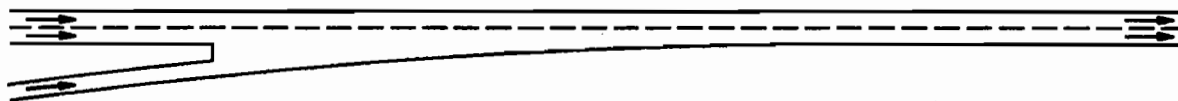

(ii) Direct taper for crossing road

Figure F5-8

Single-Lane Entrance Terminal Configuration

F.5.4.2 Two-Lane Entrances

Two-lane entrances apply to freeways and have limited application on crossing roads. An auxiliary lane is added to maintain the principles of basic lanes and lane balance, and may be discontinued further downstream or carried forward to the next exit.

The two-lane entrance is of the parallel form of design, in which the left ramp lane is continuous with the

auxiliary lane downstream, and the right ramp lane is continued for some distance beyond the bullnose and then merged with the adjacent lane illustrated in Figure F5-9 (i). Alternatively, the auxiliary lane is carried downstream to the next exit, illustrated in Figure F5-9 (ii).

The typical designs for the two-lane freeway entrance terminal are shown in Figure FA-7 in the Appendix.

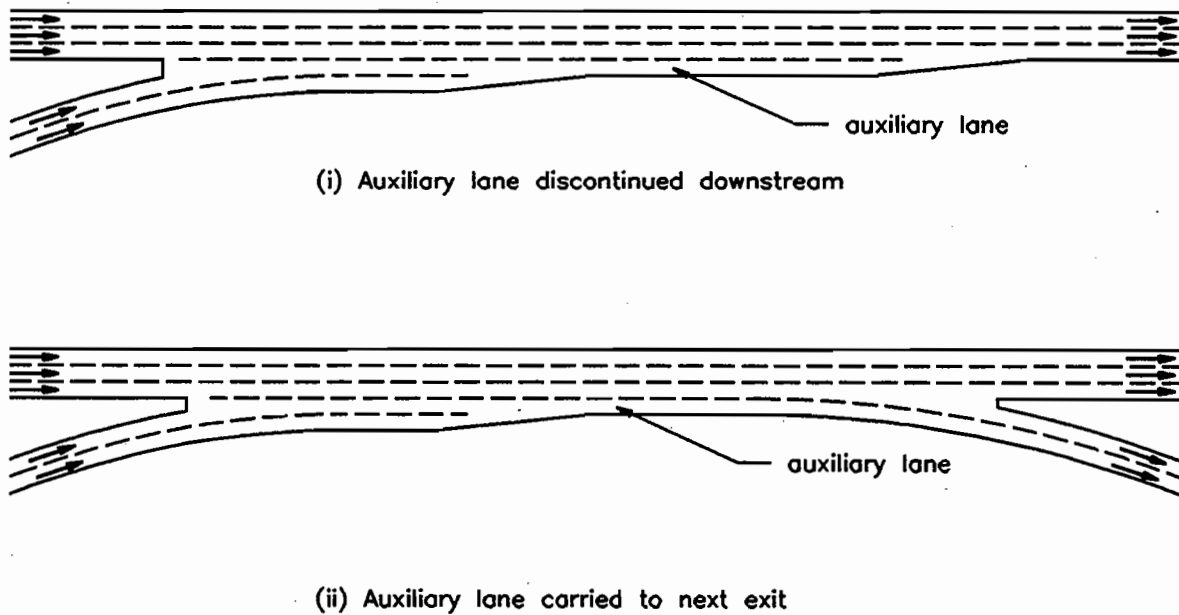
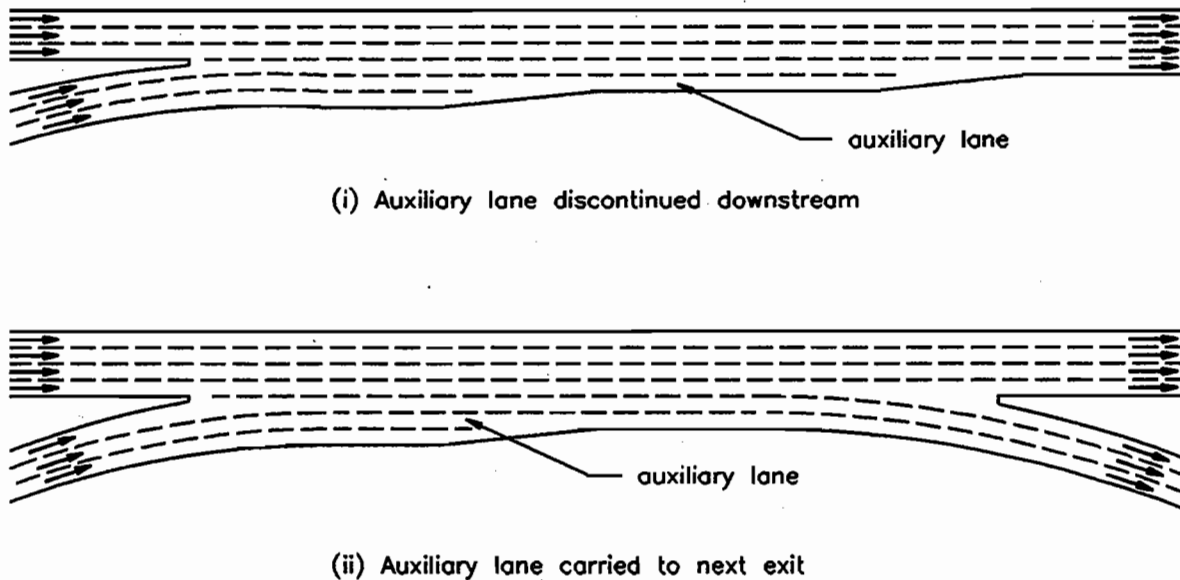

Figure F5-9
Two-Lane Freeway Entrance Terminal Configuration

F.5.4.3 Three-Lane Entrances

Three-lane entrances are sometimes required at a freeway-to-freeway interchange where there is an increase in the number of basic lanes. The design of

a three-lane freeway entrance terminal is identical to that of a two-lane entrance with an additional lane to the right. Usually, the two right lanes are auxiliary lanes and the adjacent lane is a basic lane added at the interchange, illustrated in Figure F5-10 (i) and (ii).



**Figure F5-10
Three-Lane Freeway Entrance Terminal Configuration**

F.5.4.4 Entrance Terminal Bullnoses

Bullnoses for entrance terminals may include or exclude curb and gutter. If curb and gutter is omitted the bullnose is squared off, and if it is included it is

rounded. Dimensions are shown in Figure F5-11 and in Figures FA-5 to FA-7 for both designs.

Bullnose areas normally consist of pavement only, without curb, unless drainage considerations indicate a benefit from use of curb.

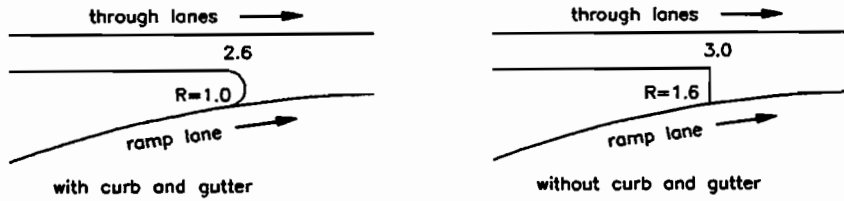

(i) Single-lane freeway entrance

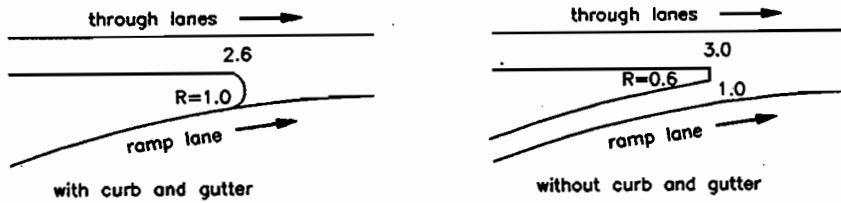

(ii) Two-lane freeway entrance

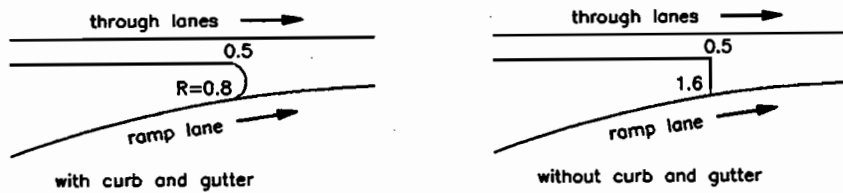

(iii) Single-lane crossing road entrance

**Figure F5-11
Entrance Terminal Bullnose and Offset Dimensions**

F.5.4.5 Sight Distance at Entrance Bullnose

At the entrance bullnose, the driver is looking for gaps in the traffic in the adjacent lanes so as to effect a lane change and merge. The driver therefore has to look back to find an appropriate gap, either by using the driving mirrors or turning the head. This view is best provided by maintaining vertical alignment of the ramp in the vicinity of the bullnose at elevations similar to those of the through roadway. If the ramp is significantly higher or lower (particularly lower), the driver may have some difficulty effecting a safe merge. A driver begins accelerating from the ramp controlling

circular curve some distance before the bullnose, usually in the vicinity of the beginning of the spiral curve. At this point, the driver looks for gaps in the stream of traffic in the adjacent lane. Referring to Figure F5-12, assuming the driver turns his head through 120° , ideally the pavement surface of the adjacent lane should be visible, or at least to a point 1 m above the surface.

The method of measurement of sight distance to the end of the entrance terminal is illustrated in Figure F5-13, and the required length of sight distance is given in Table F5-7.

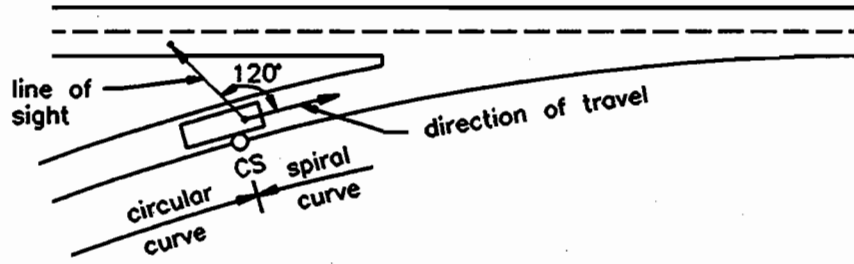
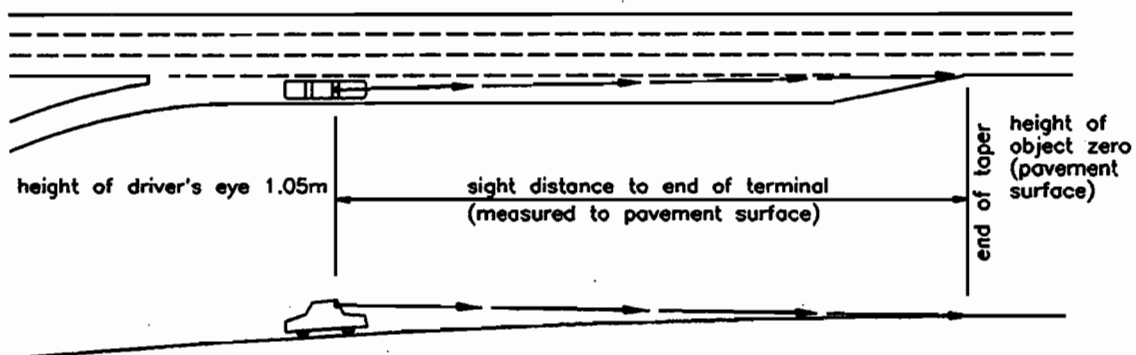

Figure F5-12

Sight Distance at Entrance Bullnose

**Table F5-7
SIGHT DISTANCE AT ENTRANCE TERMINALS**

Design Speed km/h	60	70	80	90	100	110	120
Sight Distance to End of Terminal, m	170	200	240	270	300	340	370
	to	to	to	to	to	to	to
	230	270	310	350	390	430	470



**Figure F5-13
Sight Distance at Entrance Terminals**

F.5.4.6 Design Lengths for Entrance Terminal Speed-Change Lanes

Drivers entering a highway from a ramp or turning roadway accelerate until the desired speed is reached. Because the change in speed is usually substantial, provision should be made for acceleration to be accomplished on speed-change lanes to minimize interference with through traffic and to reduce accident potential. The term speed-change lane or acceleration lane applies to the added pavement adjoining the travelled way of the highway and does not necessarily imply a lane of uniform width.

A speed-change lane should have sufficient length to enable a driver to accelerate in a safe and comfortable manner, and in addition, there should be sufficient length to permit adjustments in speeds of both through vehicles and entering vehicles so that the driver of the entering vehicle can manoeuvre into a gap in the through-traffic stream before reaching the end of the acceleration lane.

The length of an acceleration lane is based on two factors in combination, namely:

- the speed at which drivers enter the acceleration lane at the bullnose,
- the speed at which the drivers merge with the through traffic,
- the manner of accelerating.

The length of the acceleration lane may also depend on the relative volumes of through and entering traffic. Acceleration lanes up to 50% longer are desirable on higher volume roads to enable entering traffic to merge with through traffic safely and conveniently.

The speed at which the vehicle is assumed to be travelling at the bullnose is 40 km/h for design speeds up to 80 km/h and 50 km/h for design speeds above 80 km/h.

The speed at which the driver enters the through traffic stream is taken to be 5 km/h less than the assumed speed* of the highway for design speeds of 50, 60, 70 and 80 km/h. For design speeds ranging from 90 -120 km/h the speed at which the driver enters the through traffic stream is taken to be the assumed speed of the through highway.

Distances travelled during acceleration are shown in Figure F5-14. For example, a vehicle with an initial speed of 40 km/h will reach 74 km/h after travelling 150 m; a standard length of 150 m is adopted for the design speed of 80 km/h of the through roadway. A vehicle with an initial speed of 50 km/h will reach an assumed speed of 109 km/h after travelling 525 m; a standard length of 500 m is adopted for the design speed of 120 km/h of the through roadway.

Table F5-8 shows design values for length of acceleration lanes, and the diagrams indicate their application for the direct taper, single-lane or two-lane parallel ramp designs. For the parallel form the values in the table refer to the lengths of acceleration lane including taper. For the direct taper the values shown refer to the length from the bullnose to the end of the taper.

Where acceleration lanes are on grades steeper than 2% the length shown in Table F5-8 should be adjusted by the appropriate factor in Table F5-9.

Trucks and buses require longer acceleration lanes than passenger cars. Additional length is warranted if the:

- ramp traffic volume is high,
- truck traffic on the freeway is heavy,
- roadway is on an upgrade, or
- the lane drop occurs at a crest curve.

To allow the driver to make a merging manoeuvre safely, ideally he should have a view of the entire speed-change lane from the bullnose. Sight distance may be insufficient if the speed-change lane occurs on a crest curve, in which case the vertical alignment should be adjusted so as to shift the crest curve away from the speed-change lane. If this is not possible, either the speed-change lane should be lengthened or the crest curve should be flattened to provide sufficient sight distance to the end of the taper. The method of measurement of sight-distance to the end of the entrance terminal is illustrated in Figure F5-13, and the required sight distance is given in table F5-7.

* See Chapter C, Section C.2.3.1 and Table C2-1

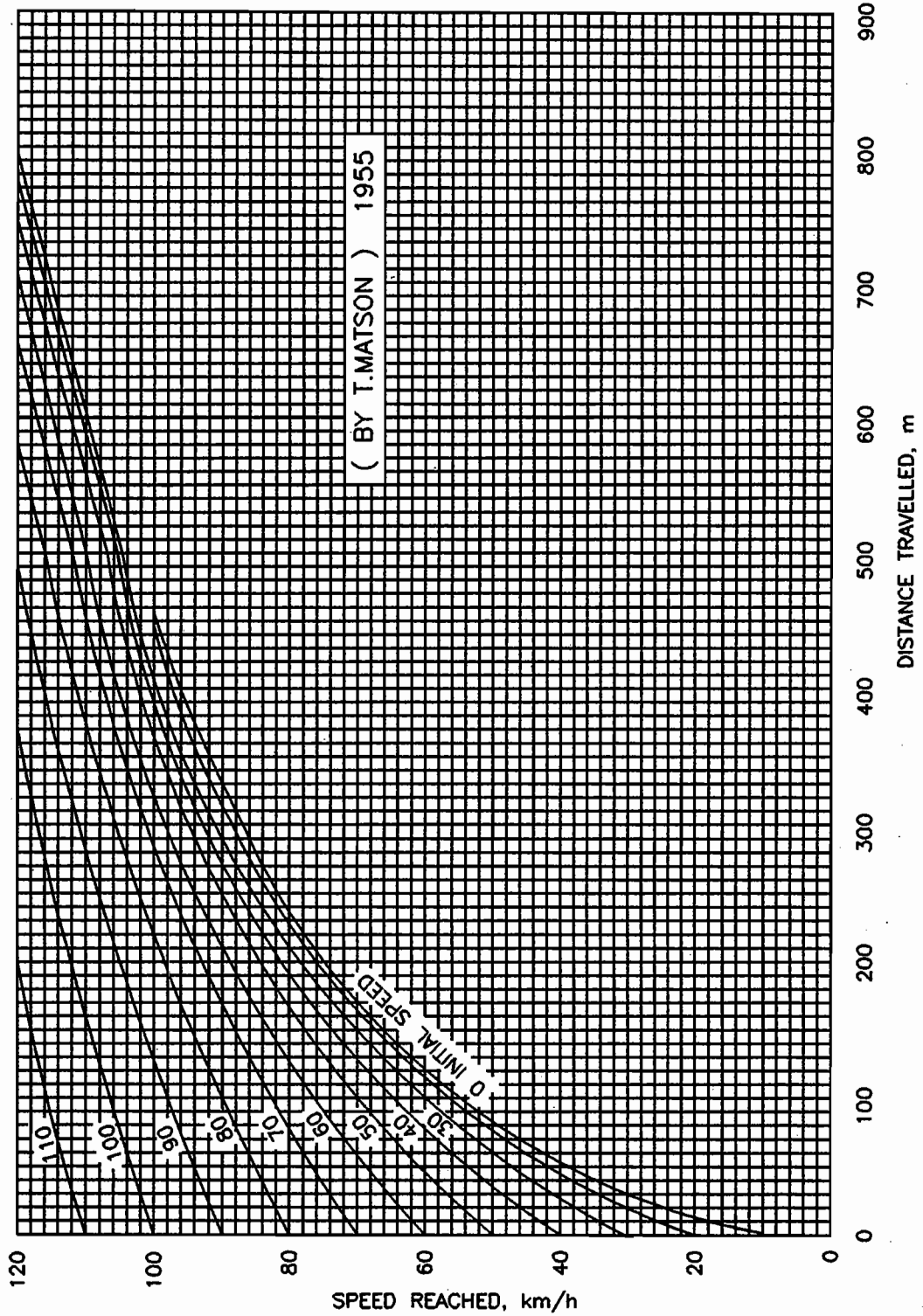
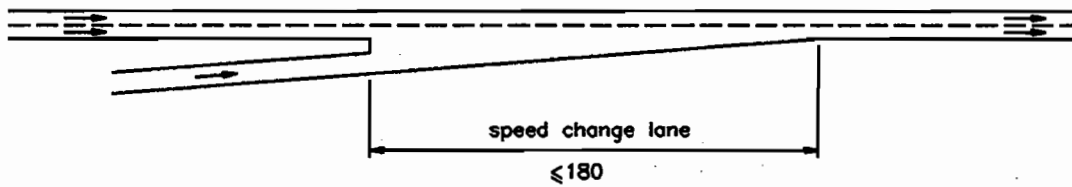

Figure F5-14
Distance Travelled During Acceleration

Table F5-8
LENGTH OF SPEED-CHANGE LANES AT ENTRANCE TERMINALS ON CROSSING ROADS AND FREEWAYS

Design Speed of Through Roadway, km/h	50	60	70	80	90	100	110	120
Speed at bullnose, km/h	40	40	40	40	50	50	50	50
Length of Speed-Change Lane								
including Taper, m	70	70	95	150	220	300	400	500
Length of Taper, m	-	-	-	-	75	80	85	90



(i) Direct taper on entrance terminal

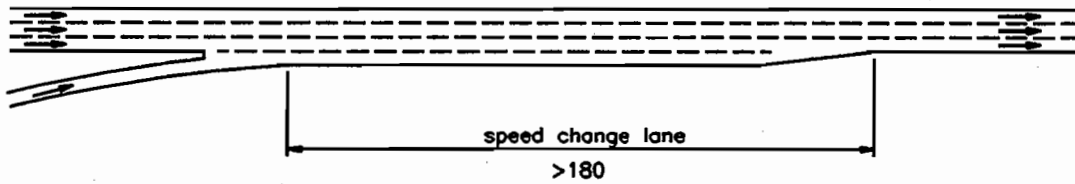

(ii) Single-lane parallel entrance terminal

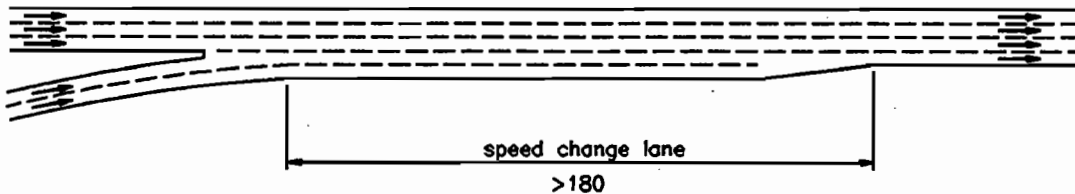

(iii) Two-lane parallel entrance terminal

Table F5-9

GRADE FACTORS FOR ENTRANCE SPEED-CHANGE LANES

Design Speed of Highway km/h	Ratio of Length on Grade to Length on Level for: Design Speed of Ramp, km/h		
	40*	50**	All Speeds
	3 to 4% Upgrade		3 to 4% Downgrade
50	1.3	-	0.7
60	1.3	1.3	0.7
70	1.3	1.4	0.7
80	1.4	1.4	0.7
90	1.4	1.5	0.7
100	1.5	1.5	0.6
110	1.5	1.6	0.6
120	1.6	1.6	0.6
	5 to 6% Upgrade		5 to 6% Downgrade
50	1.5	-	0.6
60	1.5	1.5	0.6
70	1.6	1.7	0.6
80	1.7	1.8	0.6
90	1.9	2.0	0.6
100	2.0	2.1	0.5
110	2.1	2.3	0.5
120	2.2	2.4	0.5

For grades between 2%, 3%, 4%, 5%, 6%, and over, interpolation is to be used to determine suitable ratio values.

* The speed assumed at the bullnose for crossing roads with design speeds of 50 - 80 km/h.

** The speed assumed at the bullnose for crossing roads and freeways with design speeds of 90 -120 km/h.

F.5.4.7 Successive Entrance Ramps

Where two ramps enter a freeway in close succession, for example, in the case of a parclo A-4, the configuration may be treated in one of two ways as illustrated in Figure F5-15.

The most usual treatment is to carry each ramp directly and independently to the freeway as shown in Figure F5-15, illustration (i). This form provides ramp traffic with separate opportunities to merge with through traffic and to disperse.

An alternative treatment is to merge the two ramp movements with a single movement and then to carry the combined ramp traffic onto the freeway through a single entrance, as shown in illustration (ii). This form has the disadvantage in that a stalled vehicle or accident downstream of the merging of the two ramp movements will also delay the upstream ramp traffic.

The design shown in (ii) is useful to minimize the number of ramp entrances to a freeway for example, if this were required for ramp metering.

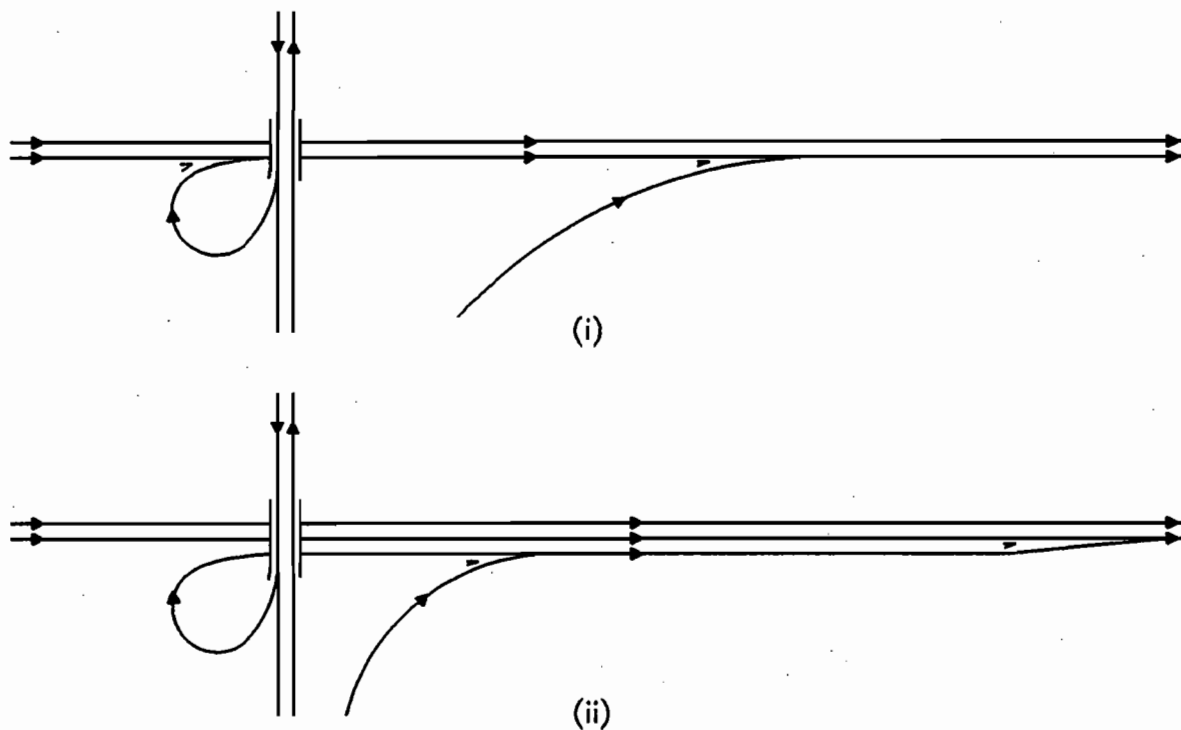

**Figure F5-15
Successive Entrance Ramps**

F.5.5 Ramp Terminal Spacing

Successive ramp terminals on a freeway or within an interchange should be spaced to allow drivers to make decisions in sufficient time to make safe manoeuvres.

In the case of successive exits, the distance must be sufficient to provide for adequate signing. In the case of successive entrances, the merging manoeuvres of the first entrance must be complete before the second entrance.

The distance between an entrance from an inner loop and an outer ramp should be a minimum of 15 m, from the end of the taper of the first entrance to the bullnose of the second entrance, see Figure FA-6.

The case of an entrance followed by an exit terminal is a weaving condition, and is discussed in Section F.4.5.

The distance between an exit followed by an entrance should be sufficient to allow a vehicle on a through lane to prepare for the merge ahead after passing the exit bullnose.

Distances shown in Figure F5-17 are minimum, and should be increased in any particular design if necessary to ensure adequate signing requirements are met.

F.5.6 Ramp Design

Ramps fall into one of three general categories illustrated in Figure F5-16, reflecting their overall configuration. Direct ramps are those having an overall deflection angle to the right of 90° more or less. Semi-direct ramps in general refer to ramps to accommodate a left-turn, having overall deflection angles in the order of 90° to the left. Inner loop ramps refer to those whose configuration resembles a loop and accommodate left-turning traffic, having an overall deflection angle of 270° to the right.

The design speed selected for a ramp design is related to the design speed of the through roadway upstream of the ramp and the configuration of the inner ramp. Guide values for ramp design speed for a range of highway design speeds are given in Table F5-1.

Horizontal and vertical alignment geometry should meet the standards and guidelines set out in Chapter C, Alignment, using the design speed shown in Table F5-1 as a guide. Profile design should always provide at least minimum stopping sight distance and normally this constraint will be more stringent than limiting values for gradient.

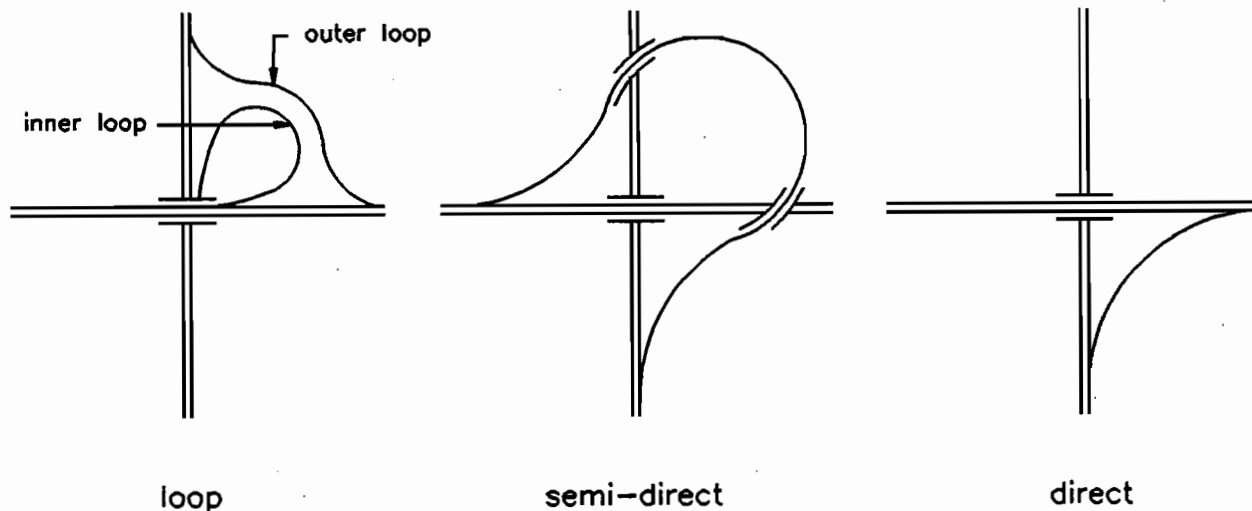

**Figure F5-16
Ramp Types**

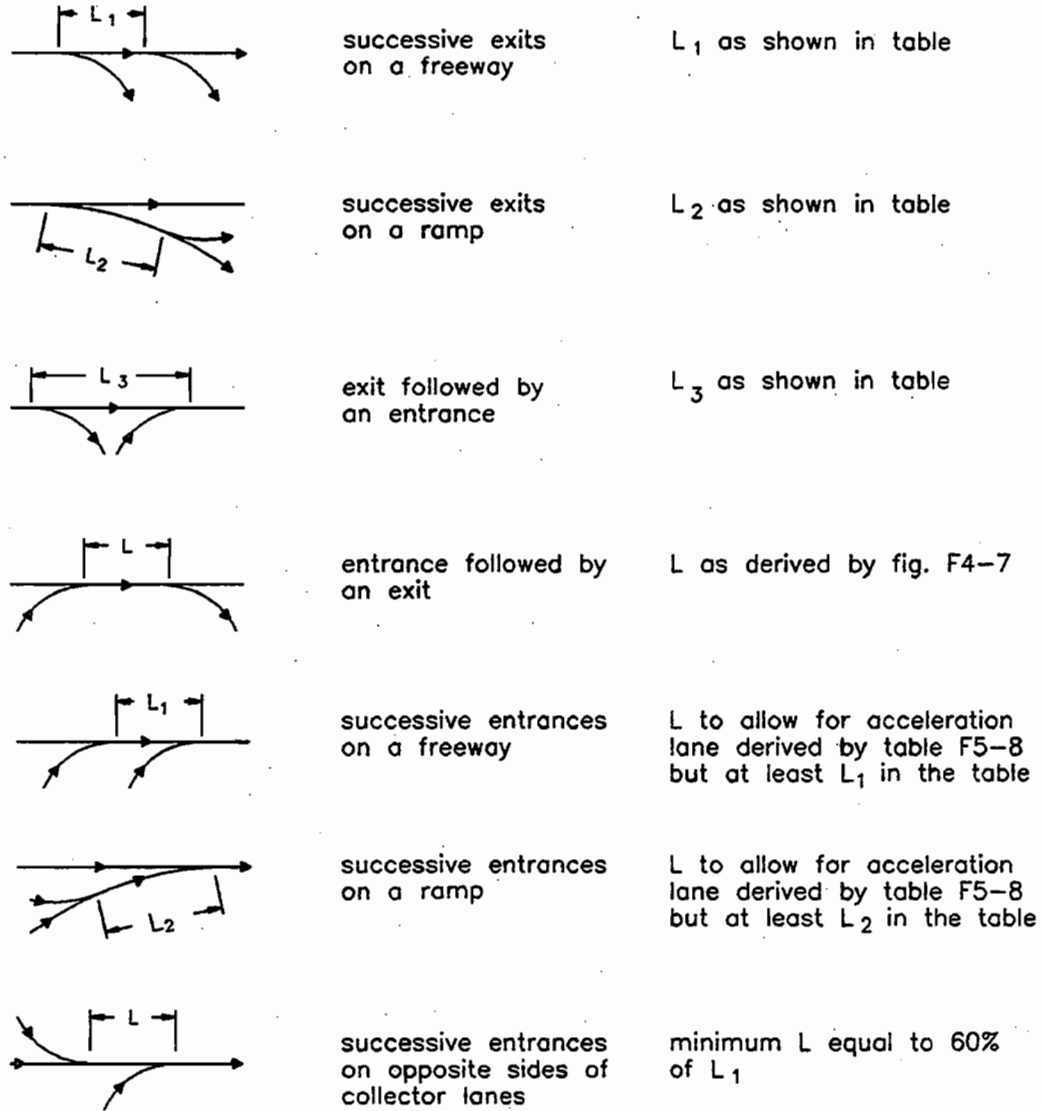

Design Speed km/h	80	90	100	110	120
L_1 m	250	275	300	325	350
L_2 m	200	225	250	275	300
L_3 m	150	150	150	175	200

Note: Minimum lengths from bullnose to bullnose

Figure F5-17
Ramp Terminal Spacing

Short upgrades as much as 5%, do not unduly interfere with truck and bus operation, and with proper terminal design, short upgrades of 8% will not unduly interfere with passenger car operation. On ramps entering freeways, downgrades assist in acceleration and the gradients up to 8% are acceptable.

For exit ramps terminating at an at-grade intersection controlled by traffic signals or a stop sign, an upgrade is an asset in assisting in deceleration, however, too steep an upgrade might slow down trucks and other heavy vehicles to the degree that traffic may back up on a freeway.

Cross-fall and superelevation should be applied to ramps as outlined in Chapter D, Section D.4 applying the guideline design speeds of Table F5-1. However, on exit ramps having curvilinear alignment, it is generally prudent and practical to exceed the superelevation indicated by the design speed, since overdriving on exit ramps is common and additional superelevation assists in promoting safety, with little or no adverse effect on slow moving vehicles.

POLICY

MAXIMUM SUPERELEVATION ON RAMPS IS AS FOLLOWS:

- FOR URBAN INTERCHANGE RAMPS WHERE A HIGH LEVEL OF MAINTENANCE PREVAILS AND LITTLE ICE OR SNOW ACCUMULATION IS ANTICIPATED: 0.08 M/M
- FOR ALL OTHER RAMPS: 0.06 M/M

In interchange quadrants in which both inner and outer loops occur, (for example in the parclo A and parclo B configuration) where the two ramps are close, traffic on the ramps are travelling in opposite directions. The geometry should be checked and if necessary adjusted to ensure that drivers are not facing directly the headlights of the opposing vehicle, and sufficient vertical and horizontal separation should be provided to avoid retaining walls between the two ramps.

F.5.7 Typical Designs

The appendix to the chapter includes designs for exit and entrance terminals shown in Figures FA-1 to FA-7. A design for a major fork is shown in Figure FA-8. Designs for a number of commonly used parclo A and parclo B ramp terminals at crossing roads are shown in Figures FA-9 to FA-13, Figures FA-14 and FA-15 represent typical designs for transfer roadways between the collector and express lanes.

These designs should be regarded as typical rather than standard, and are for the guidance of the designer. Rigid adherence to these designs may produce unsatisfactory operation in some cases. Dimensions are typical and variations are required to suit local conditions of alignment, grade, profile, traffic volume, traffic mix and local physical and environmental features. Nor are the designs necessarily complete in every detail, and additional detailing may be required.

F.6 COLLECTOR LANES

F.6.1 General

Collector lanes are separate from and parallel to the express lanes and perform the function of collecting and distributing traffic between arterial roads and the express lanes. Collector lanes in terms of classification are freeways, having full control of access, no at-grade intersections and interchanging with crossing arterial roads with normal freeway-arterial type interchanges. Geometric design features and characteristics are essentially those of a freeway, however, distribution to and from the through express lanes is via transfer lanes which generate a number of left exits and entrances on the collector lanes.

F.6.2 Benefits

Collector lanes normally have two or three basic lanes in each direction, which when added to a normal three or four basic lanes in each direction on the express lanes, provide a total capacity of five to seven basic lanes in each direction. Spreading large numbers of basic lanes on separate roadways instead of a single roadway has some advantages.

Traffic on roadways of not more than four basic lanes is always within one lane of a shoulder in case of emergency. With five or more basic lanes, traffic has to change at least two lanes to reach a shoulder for an emergency stop. This is hazardous both for the vehicle requiring the shoulder and other traffic on the roadway.

Traffic on the express lanes of an express-collector system is through traffic on relatively long trips. Transfer lanes to and from the collector lanes are relatively infrequent and therefore, the through traffic is comparatively uninterrupted by entering and exit traffic. Weaving manoeuvres associated with entering traffic and exiting traffic are confined to the collector lanes.

F.6.3 Design Features

Design speed and other design criteria for collector lanes are the same as for the adjacent express lanes. Geometric design features of alignment, profile and cross section elements should meet the same standards as those for the express lanes. The principles of good lane balance, maintenance of basic lanes and the dimensions of ramp terminals should be applied.

Collector lanes are separated from the express lanes carrying traffic in the same location by an outer separation. An outer separation is similar to a median in design but different in function, in that it separates traffic travelling in the same direction. Outer separations normally contain two shoulders and a barrier to prevent traffic crossing between the two roadways or at least a fence to discourage it. Because collector lanes have left

exits and entrances to transfer lanes, lane continuity is an important consideration. This is defined and discussed in Section F4.6 and the design of collector lanes should be carefully checked to ensure that continuity of basic lanes is maintained. Where continuity is lost, it can usually be corrected by the application of auxiliary lanes between successive entrance and exits, illustrated in Figure F4-8.

The complexity of roads entering and exiting collector roads from both right and left, makes proper signing critical to the successful operation of these facilities. Before finalizing the location of transfer lanes, interchanges and ramps, it should be checked to ensure that it can be adequately signed and readily understood by the driver, particularly the unfamiliar driver. Advance signing well ahead of exits is essential for the smooth operation of collector roads.

F.6.4 Transfer Lanes

Transfer lanes between collector roads and express lanes are similar to ramps between freeways, in that they carry traffic between two controlled access facilities. Transfer lanes are relatively short and level unless they are part of a basket weave configuration between collector lanes and express lanes. Like ramps they consist of three elements, the exit terminal, the entrance terminal and the section between the two bullnoses or transfer lanes proper.

Whereas the design speed of a ramp is normally less than that of the associated freeway, the design speed of a transfer lane should be the same as that of the freeway, since the driver travelling between the two roadways does not adjust speed to make this manoeuvre.

Transfer roadways normally have two lanes. Although design volumes may indicate that one lane is sufficient, it is generally considered that two lanes are required to provide the necessary degree of flexibility to accommodate a variety of traffic patterns, for traffic moving between collector and express lanes. Transfer lane widths are the same as those of through freeway lanes and shoulders on both sides of the transfer lanes should be maintained.

Alignment and profile geometrics should be consistent with design speed, discussed above. Visibility to exit bullnoses on transfer lanes is important and decision sight distance to exit terminal bullnoses suggested in Section F5.3.6 applies.

Transfer lanes are usually preceded by or followed by a weaving section on the collector lanes. This is illustrated in Figure F6-1. Since the transfer lanes are in effect left exits and entrances, the weaving induced on the collector lanes is more intensive than under the more common condition in which a right entrance is followed by a right exit.

In that case weaving is between the two ramp movements and the through freeway traffic is not part of the weaving manoeuvre. In the case of the transfer lanes on the collector lane much, if not all, of the traffic on the transfer lane is weaving with the through collector lanes traffic. This calls for additional weaving length over that of the normal right entrance/right exit condition. These weaving sections merit detailed analysis applying the techniques in Chapter B.

Typical designs for transfer roadways are shown in Figure FA-14 and FA-15 in the appendix to the chapter.

F.6.5 Basket Weaves

A basket weave consists of a pair of transfer lanes crossing each other and separated vertically. The successful operation of the basket weave depends on the geometrics of the alignment and profile. Drivers expect to be able to maintain speeds close to freeway speeds when transferring between express lanes and collector lanes in a basket weave. For this reason, design speed in the basket weave should be not less than 10 km/h less than the design speed of the express and collector roads.

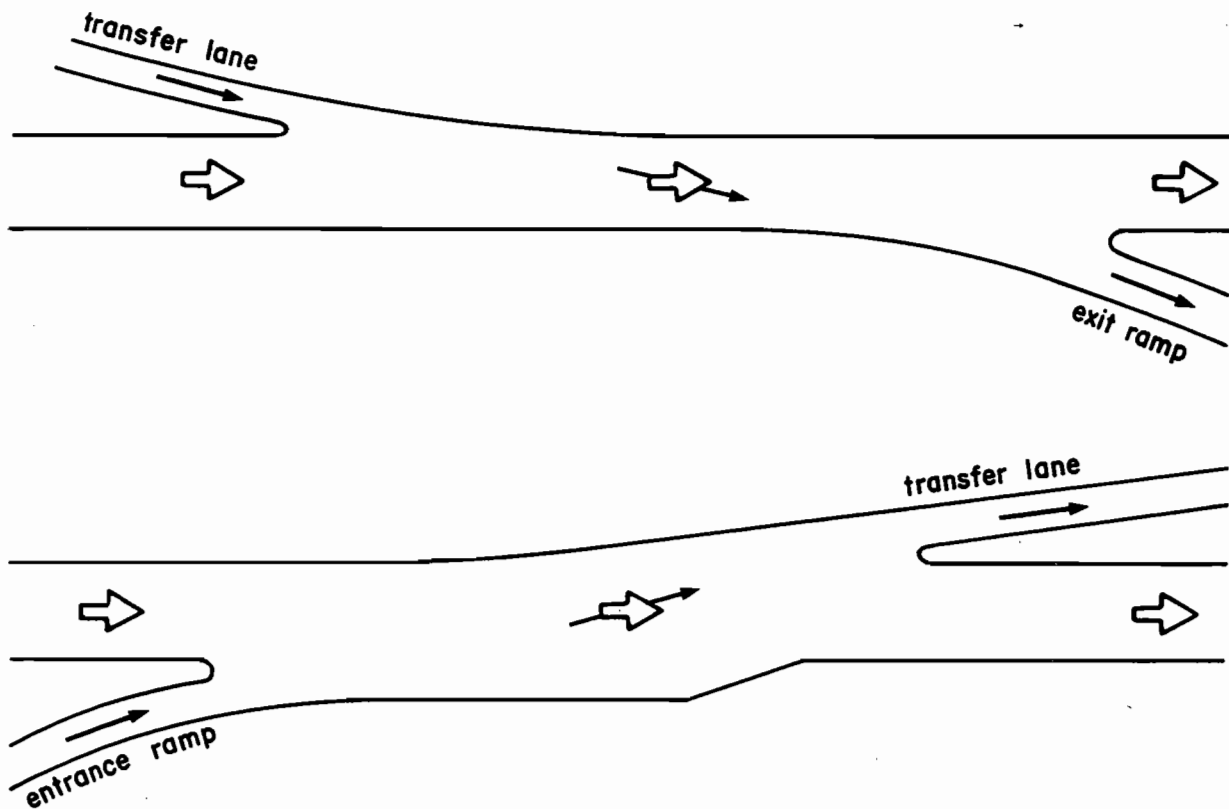

Figure F6-1

Weaving on Collector Lanes Due to Transfer Lanes

APPENDIX

TYPICAL DESIGNS

The Appendix contains typical designs for exit terminals, entrance terminals and some commonly used parclo A and parclo B ramp terminals at crossing roads. These designs should be regarded as typical rather than standard, and are for the guidance of the designer. Rigid adherence to these designs may produce unsatisfactory operation in some cases. Dimensions are typical and variations are required to suit local conditions of alignment, grade, profile, traffic volume, traffic mix and local physical and environmental features. Nor are the designs necessarily complete in every detail, and additional detailing may be required.

	DESIGN SPEED OF HWY.	TOTAL LENGTH OF S.C.L. L_E	LENGTH OF GORE AREA L_g	OFFSET AT BULL-NOSE f	DEFLECTION ANGLE Δ
	km/h	m			o
	60	DIRECT SPIRAL			
DIRECT TAPER	60	60	17	1.2	8
	70	85	26	1.4	6
	80	110	35	1.6	5
	90	150	51	1.8	3
	100	180	63	2.0	3
110	PARALLEL LANE				

Note: FOR RAMP RADII REFER TO TABLE F5-1; FOR RAMP SPIRAL PARAMETERS REFER TO CHAPTER C, SECTION C.3.3.

Note: adjustment to some dimensions is required for grade, see table F5-6

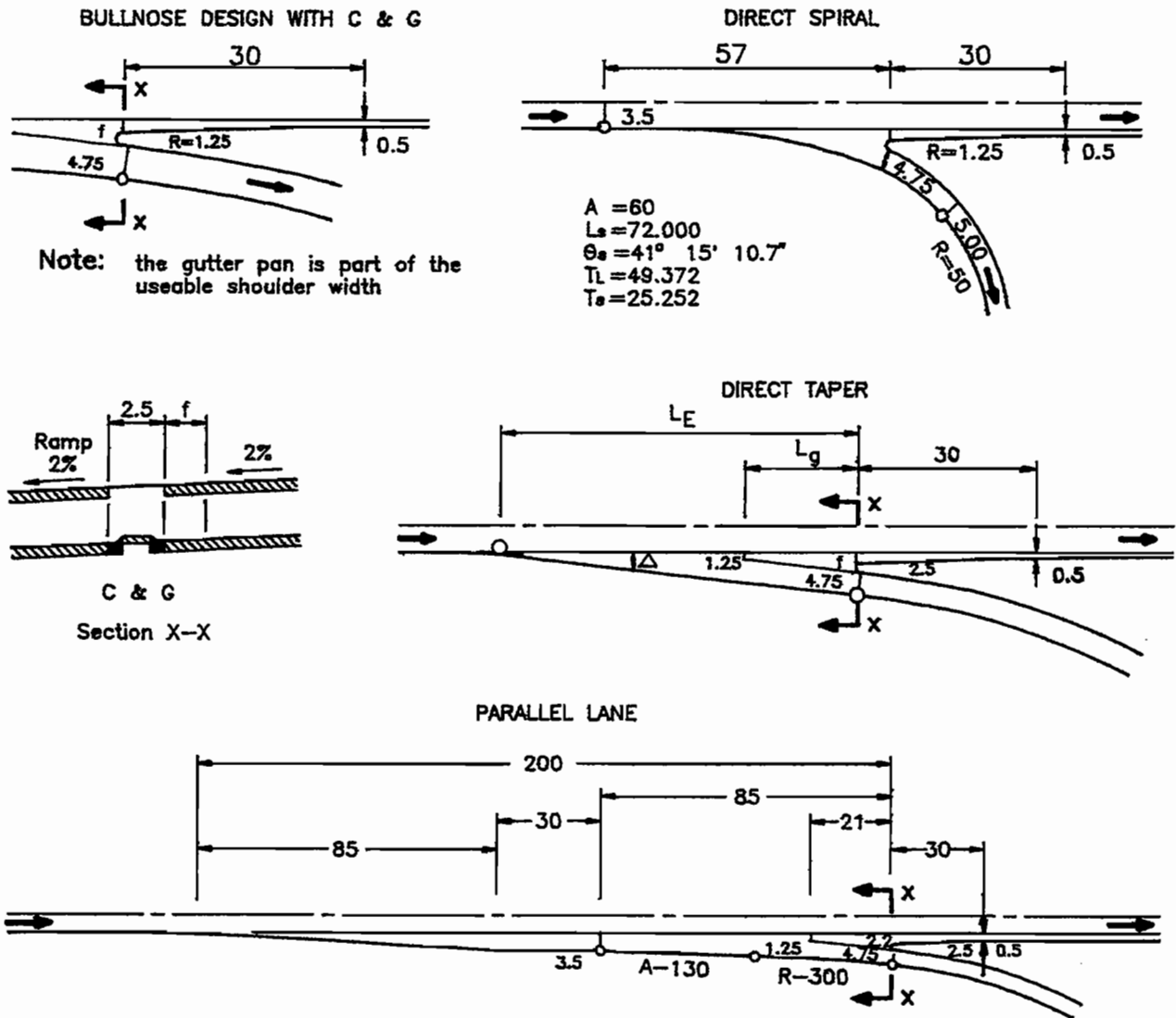
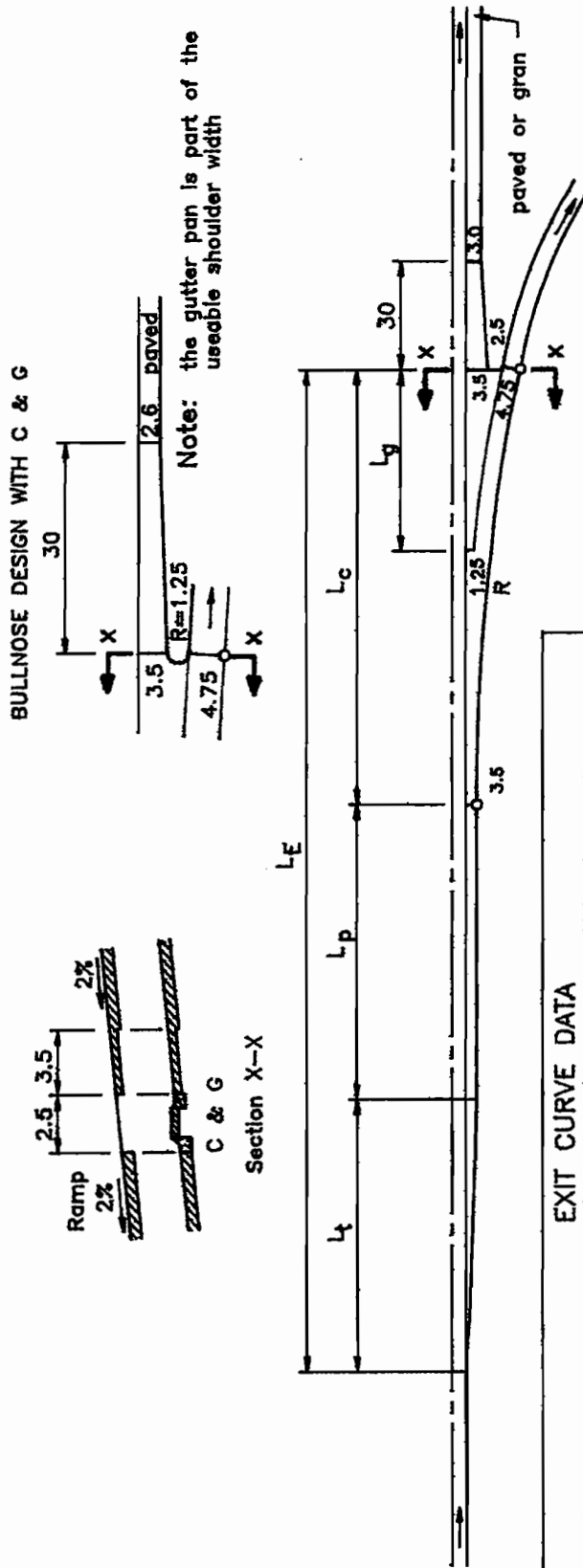

Figure FA-1
Single-Lane Crossing Road Exit Terminal

DESIGN SPEED OF HWY.	TOTAL LENGTH OF S.C.L. INCL. TAPER L _E	TO INNER LOOP				TO OUTER LOOP				
		RADIUS R	DEFLECTION ANGLE Δ	GORE AREA L _g	LENGTH OF PARALLEL SECTION L _p	RADIUS R	DEFLECTION ANGLE Δ	GORE AREA L _g	LENGTH OF PARALLEL SECTION L _p	TAPER LENGTH L _t
km/h	m	m	o	m	m	o	m	m	m	m
100	290	1000	7	50	121	89	50	121	89	80
110	315	1250	6	56	135	85	56	135	85	85
120	345	1500	5	61	148	107	61	148	107	90

Note: adjustment to some dimensions is required for grade, see table F5--6



Note:
FOR RAMP RADII REFER TO TABLE F5--1;
FOR RAMP SPIRAL PARAMETERS REFER TO
CHAPTER C, SECTION C.3.3.

EXIT CURVE DATA				
Δ	6°55'15"	6°11'15"	5°38'45"	3°59'15"
R	1000	1250	1500	3000
T	60.481	67.561	73.964	104.435
L	120.816	134.990	147.808	208.785

Figure FA-2
Single-Lane Freeway Exit Terminal

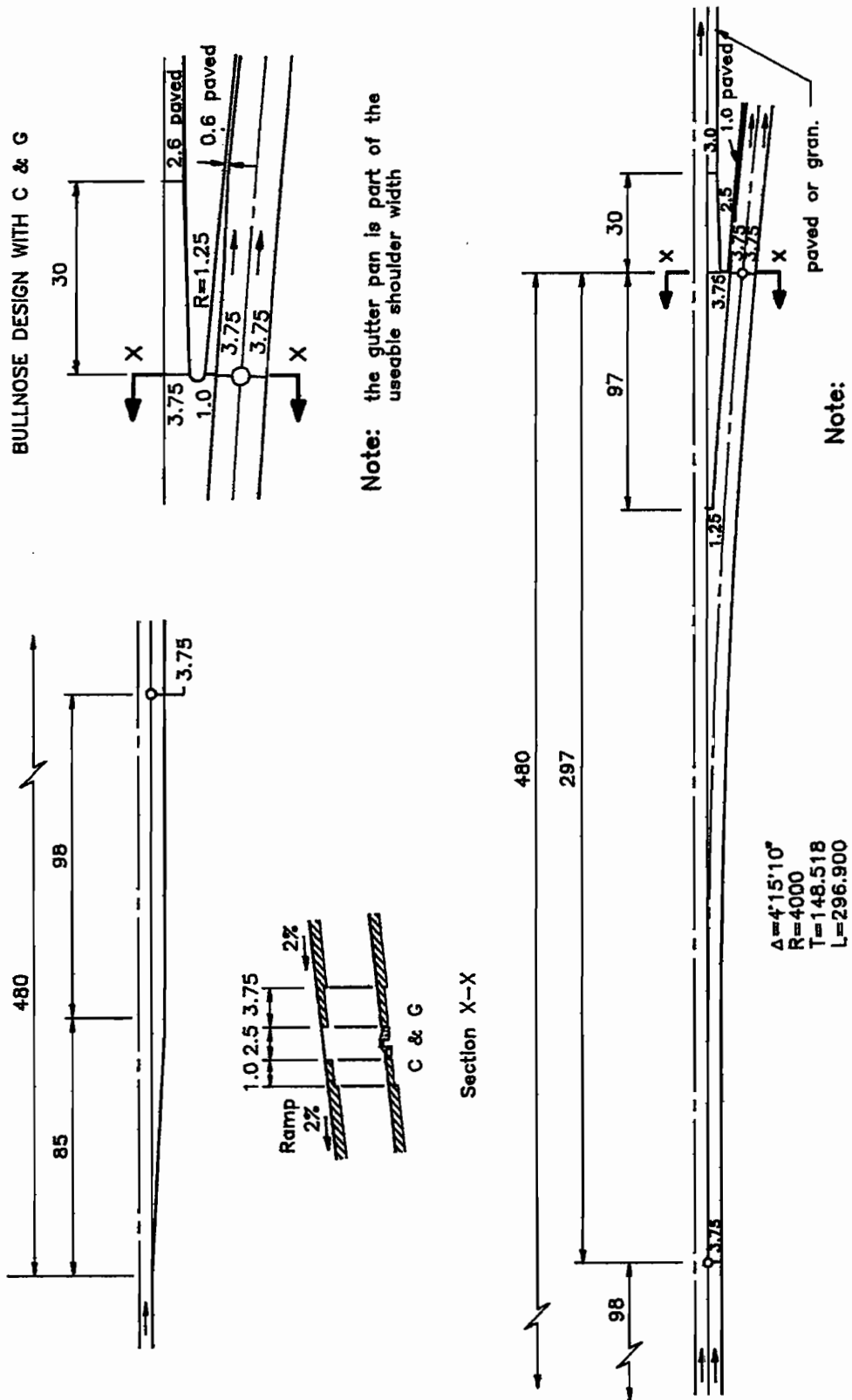
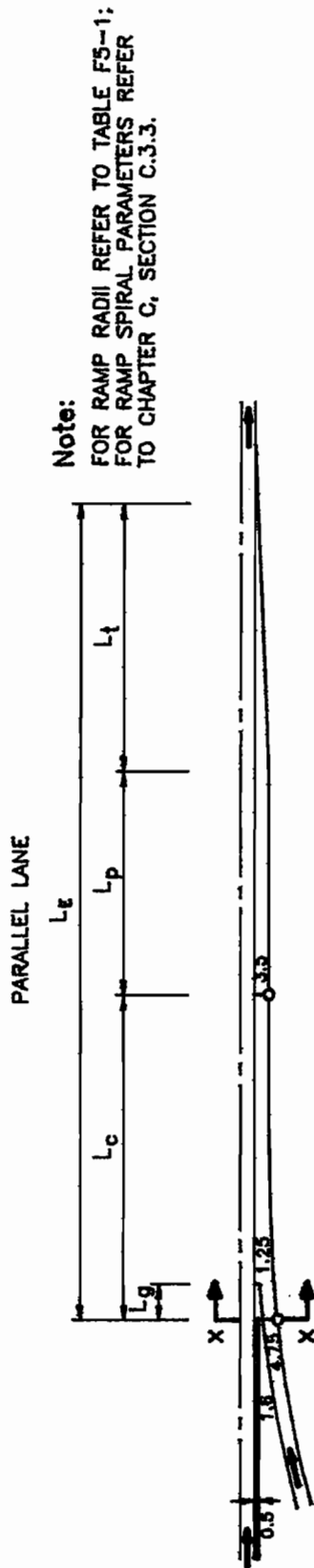
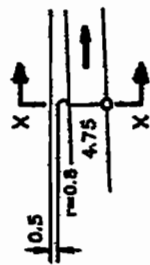

Figure FA-3
Two-Lane Freeway Exit Terminal, 110 km/h



DESIGN SPEED OF HWY	TOTAL LENGTH OF S.C.L. INCL. TAPER	ENTRANCE CURVE		LENGTH OF			
		RADIUS R	DEFLECTION ANGLE Δ	GORE AREA L_g	CURVE SECTION L_c	PARALLEL SECTION L_p	TAPER L_t
50 & 60	70	1000	6	9			
70	95	1000	4	12			
80	150	1200	3	19			
90	220	1000		11	82	63	75
100	300	1000		11	82	138	80
110	400	1250		12	90	225	85

BULLNOSE DESIGN WITH C & G



Note: the gutter pan is part of the useable shoulder width

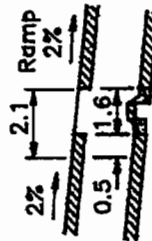

C & G

Section X-X

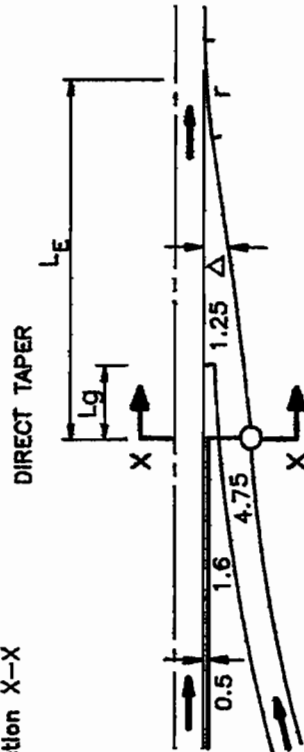

ENTRANCE CURVE DATA	ENTRANCE CURVE DATA	
	FROM INNER LOOP	FROM OUTER LOOP
Δ	4°42'10"	4°17'30"
R	1000	1200
T	41.063	44.963
L	88.884	91.721

Figure FA-5
Single-Lane Crossing Road Entrance Terminal

DESIGN SPEED OF HWY	TOTAL LENGTH OF S.C.L. INCL TAPER L_E	FROM INNER LOOP				FROM OUTER LOOP				TAPER LENGTH L_t
		EXIT CURVE	DEFLECTION ANGLE Δ	RADIUS R	LENGTH OF GORE CURVE AREA L_g	PARALLEL SECTION L_c	EXIT CURVE	DEFLECTION ANGLE Δ	RADIUS R	
km/h	m	m	o	m	m	m	o	m	m	m
100	300	1000	6	37	108	112	4	53	153	67
110	400	1200	6	41	119	196	4	65	187	128
120	500	1500	5	46	133	277	3	75	216	194

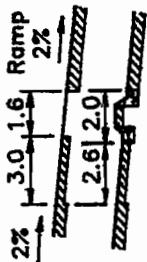

Section X-X

BULLNOSE DESIGN WITH C & G

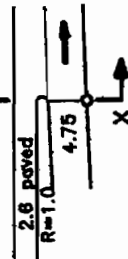

Note: the gutter pan is part of the useable shoulder width

THIS DESIGN IS USED WHEN LOCAL CONDITIONS WARRANT

110	400	1000	6	37	108	207
120	500	1000	6	37	108	302

Note: adjustment to some dimensions is required for grade, see table F5-9

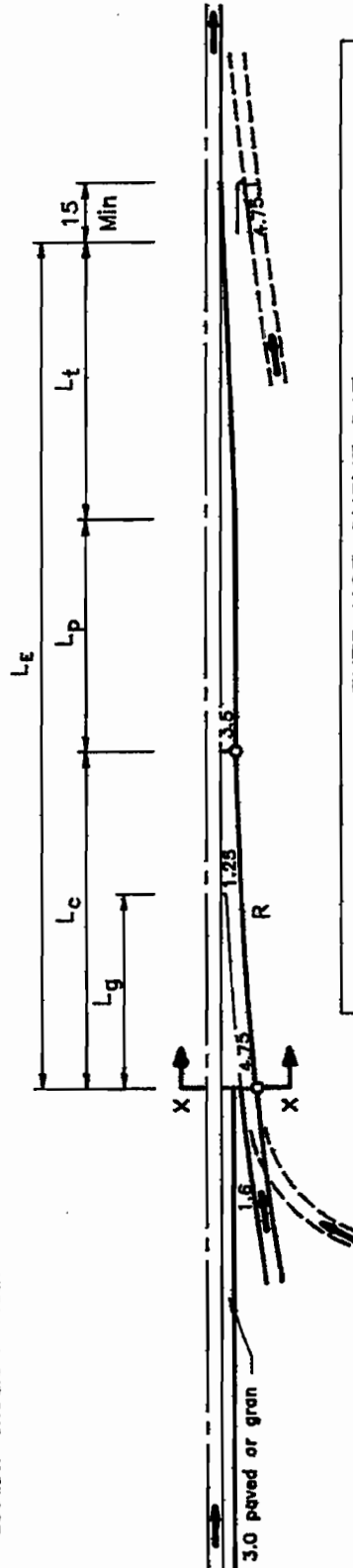

ENTRANCE CURVE DATA						
Δ	6°13'00"	5°40'20"	5°04'15"	4°23'20"	3°34'55"	3°06'00"
R	1000	1200	1500	2000	3000	4000
T	54.304	59.448	66.420	76.638	93.806	108.237
L	108.501	118.799	132.754	153.201	187.550	216.421

Note: FOR RAMP RADI REFER TO TABLE F5-1; FOR RAMP SPIRAL PARAMETERS REFER TO CHAPTER C, SECTION C.3.3.

Figure FA-6 Single-Lane Freeway Entrance Terminal

DESIGN SPEED OF HWY	TOTAL LENGTH OF S.C.L. INCL. TAPER L_E	ENTRANCE CURVE			LENGTH OF		
		RADIUS R	DEFLECTION ANGLE Δ	GORE AREA L_g	CURVE L_c	PARALLEL SECTION L_p	TAPER L_t
km/h	m	m	o		m		
110	400	3000	3	80	166	149	85
120	500	4000	3	92	192	218	90

Note: adjustment to some dimensions is required for grade; see table F5-8

BULLNOSE DESIGN WITH C & G



Note: the gutter pan is part of the useable shoulder width

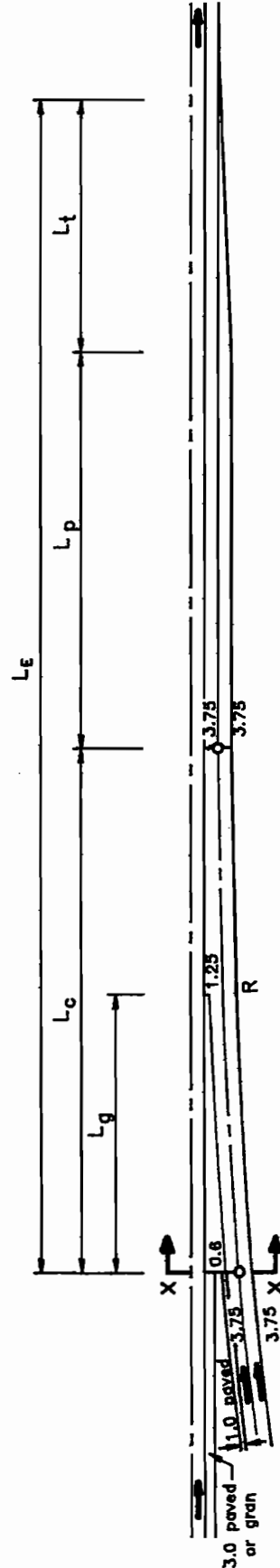

ENTRANCE CURVE DATA	
Δ	3°10'30"
R	3000
T	83.143
L	166.243

Note:
FOR RAMP RADII REFER TO TABLE F5-1;
FOR RAMP SPIRAL PARAMETERS REFER TO CHAPTER C, SECTION C.3.3.

Figure FA-7
Two-Lane Freeway Entrance Terminal

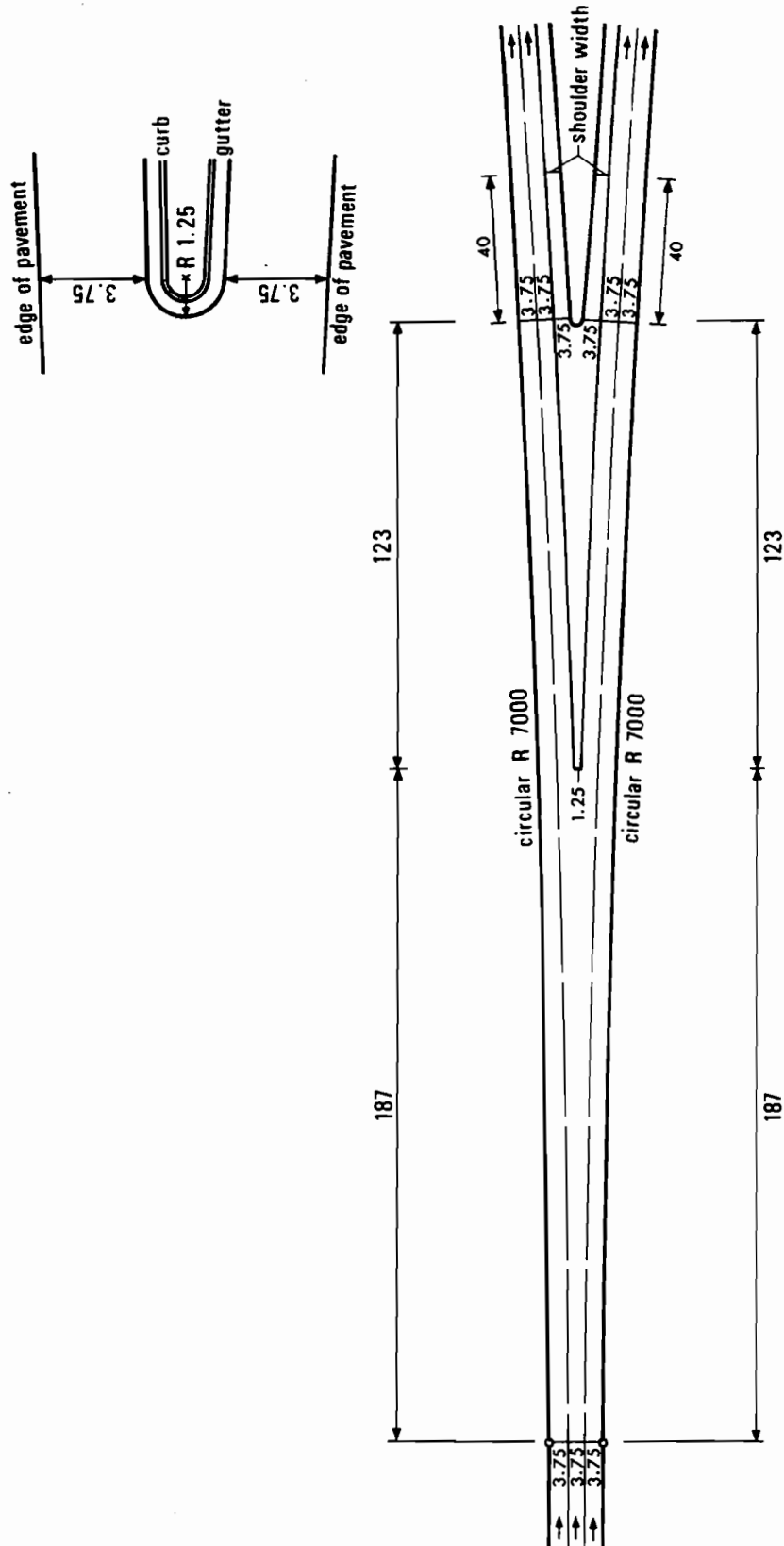

Figure FA-8
Major Fork

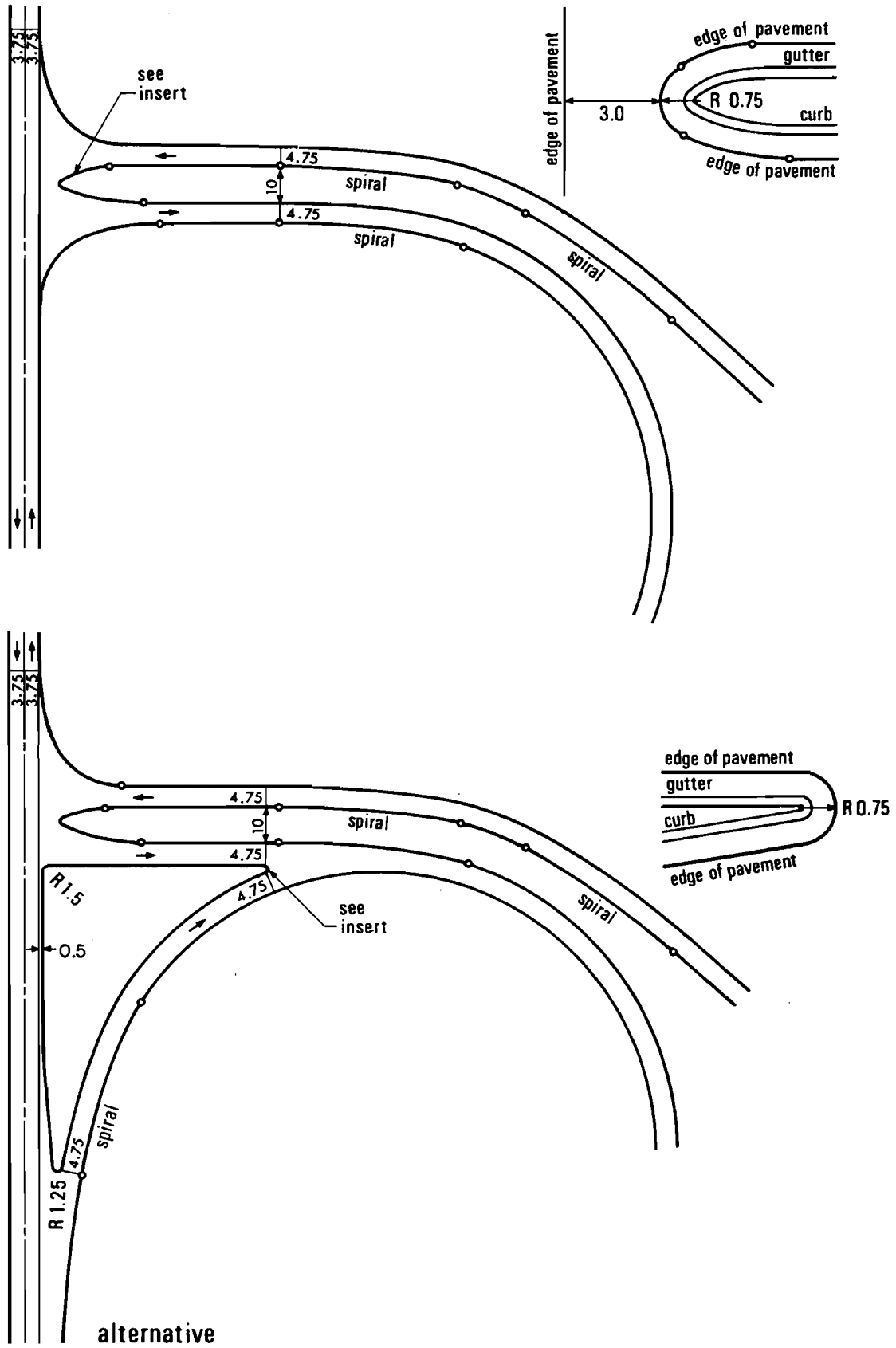

Figure FA-9
Parclo A-2 Crossing Road Terminal

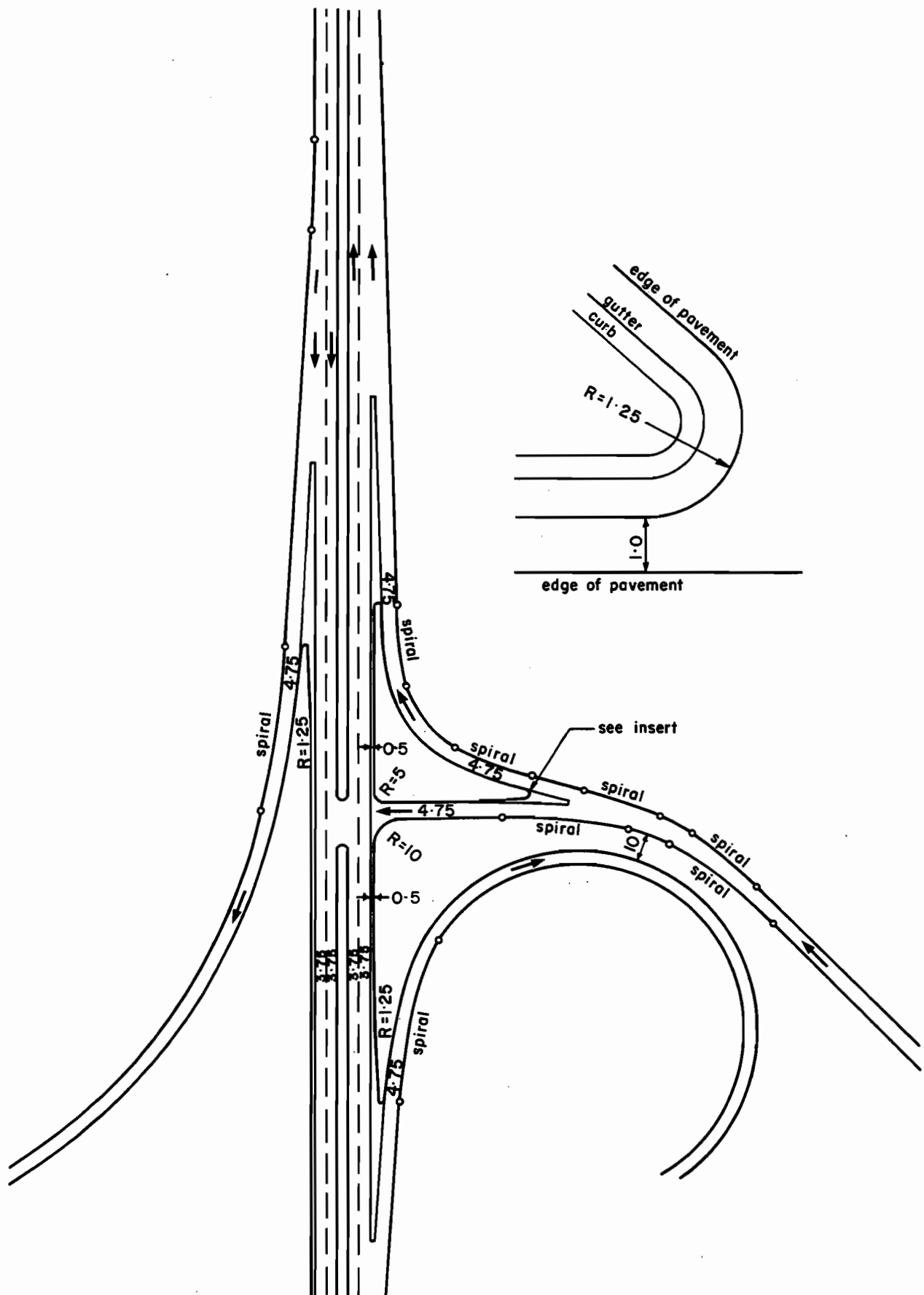

Figure FA-10
Parclo A-4 Crossing Road Terminal, One Left-Turning Lane

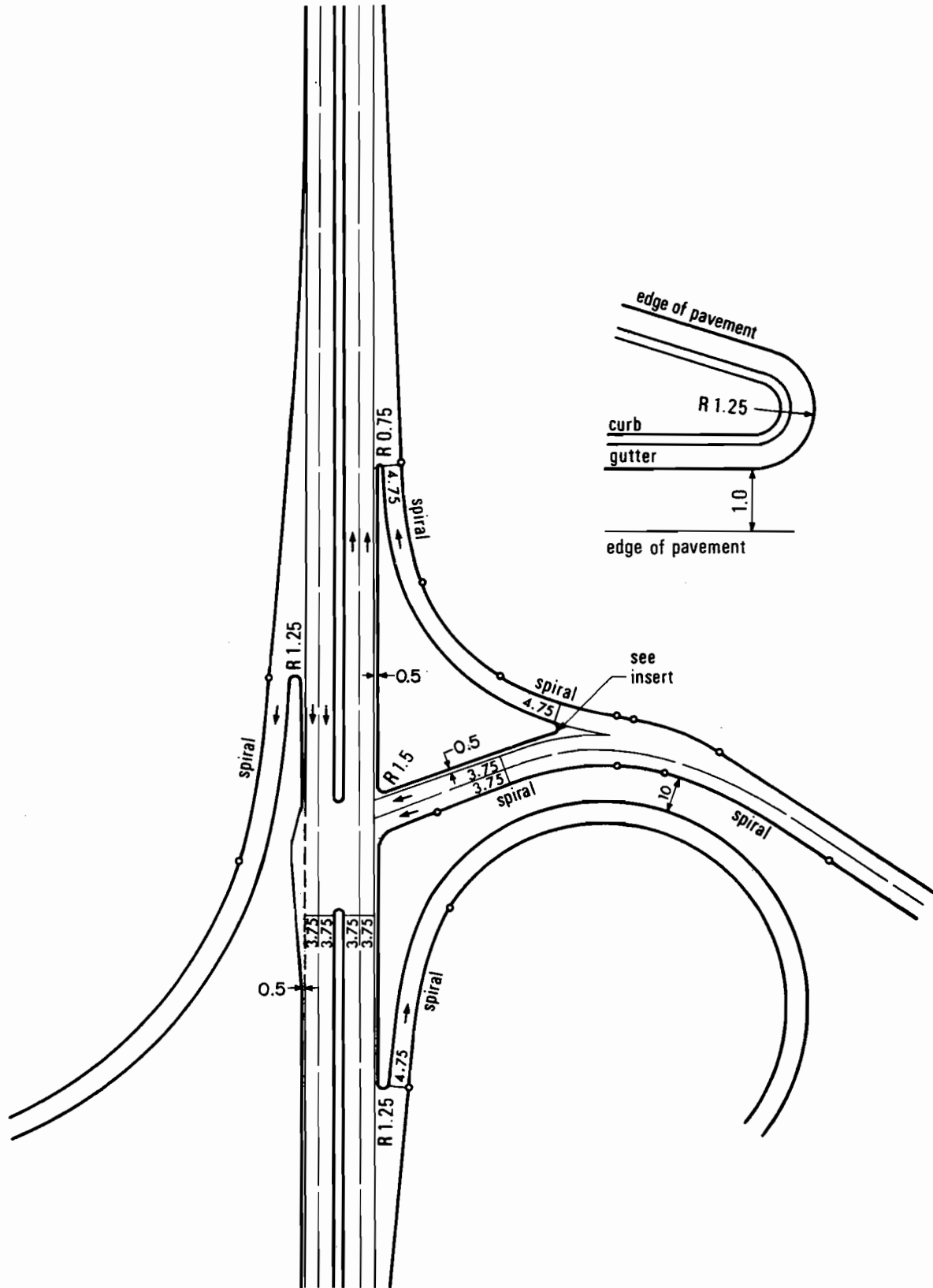

Figure FA-11
Parclo A-4 Crossing Road Terminal, Two Left-Turning Lanes

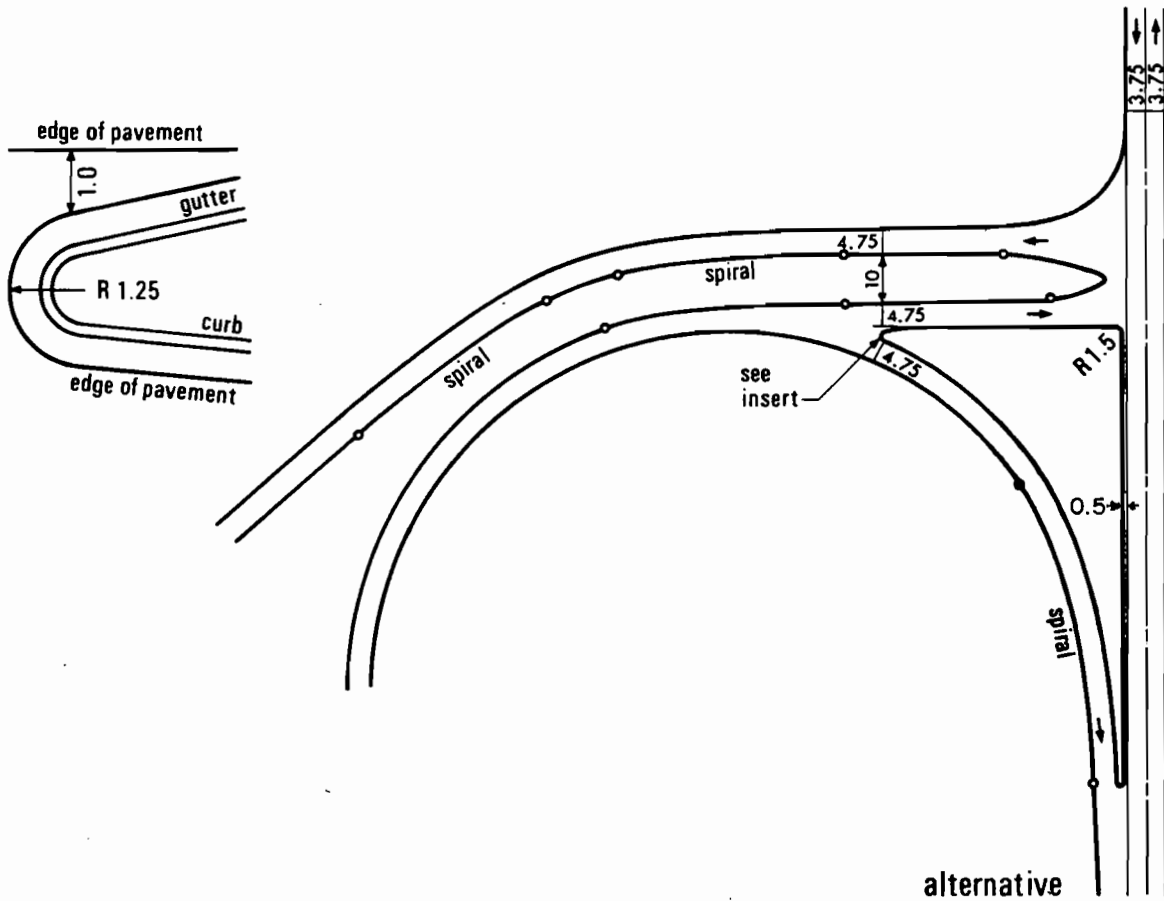
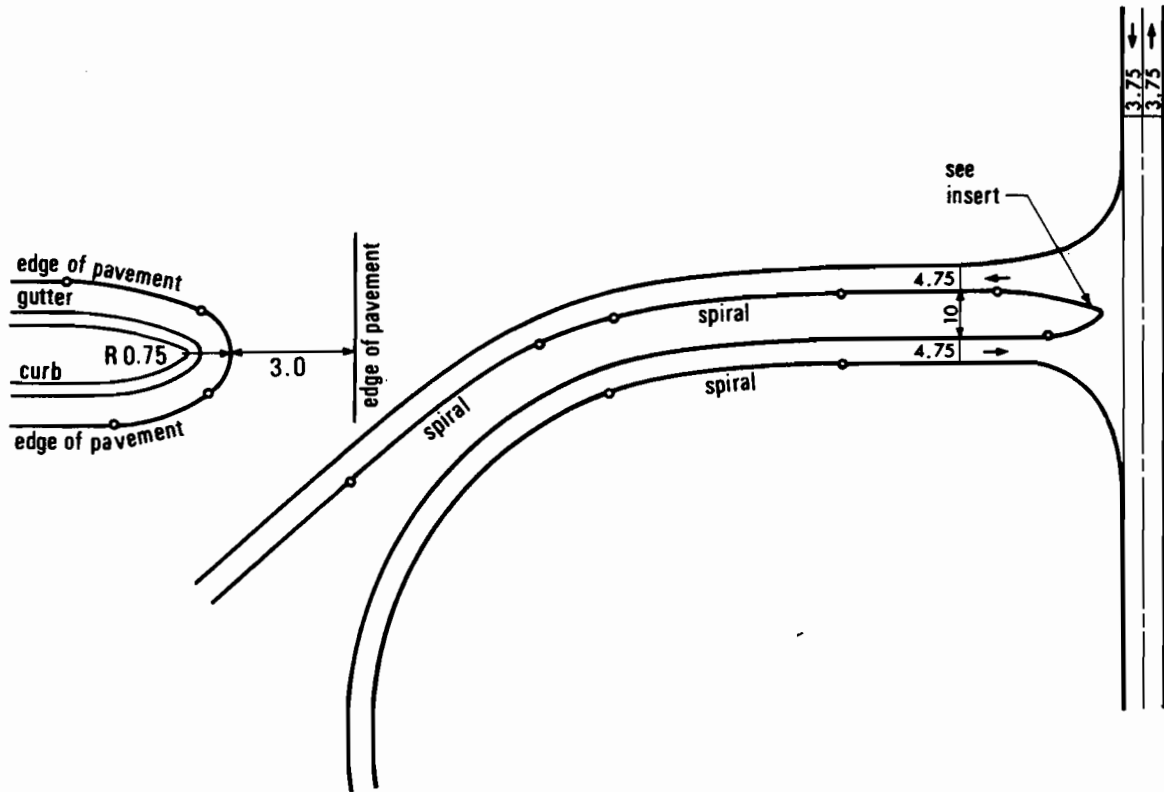

Figure FA-12
Parclo B-2 Crossing Road Terminal

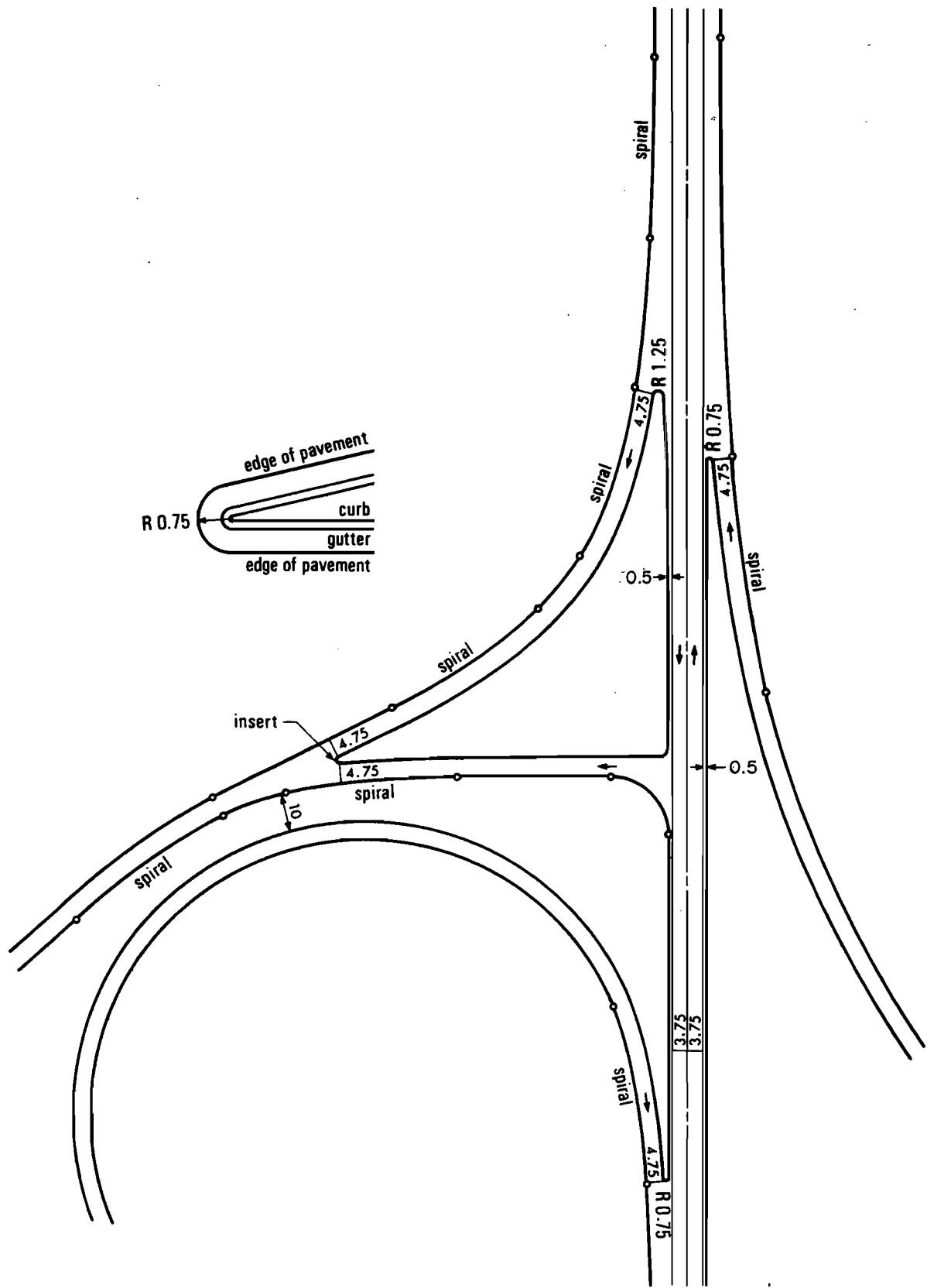

Figure FA-13
Parcio B-4 Crossing Road Terminal

- notes:
1. outer separation width @ 7.5 m min.
 2. median width may be adjusted to fit other design conditions
 3. lane balancing and continuity to be applied
 4. terminal design to be based on tables F.5-2,F.5-5,F.5-6, F.5-7, F.5-8.

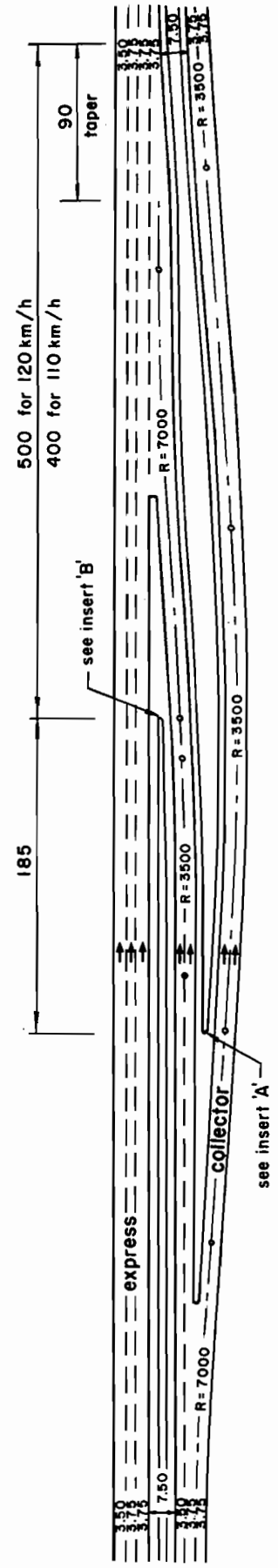
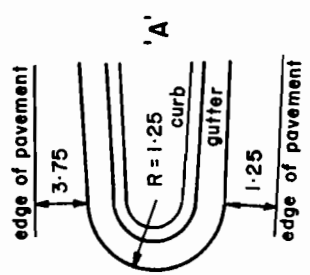
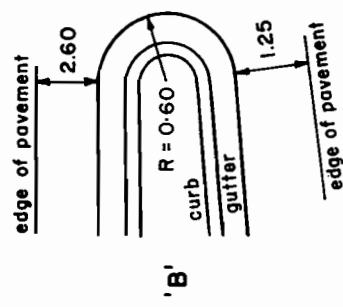

Figure FA-14
Transfer Roadway; Collector to Express Lanes

- notes:
1. outer separation width @ 7.5m min
 2. median width may be adjusted to fit other design conditions
 3. lane balancing and continuity to be applied
 4. terminal design to be based on tables F.5-2, F.5-5, F.5-6, F.5-7, F.5-8

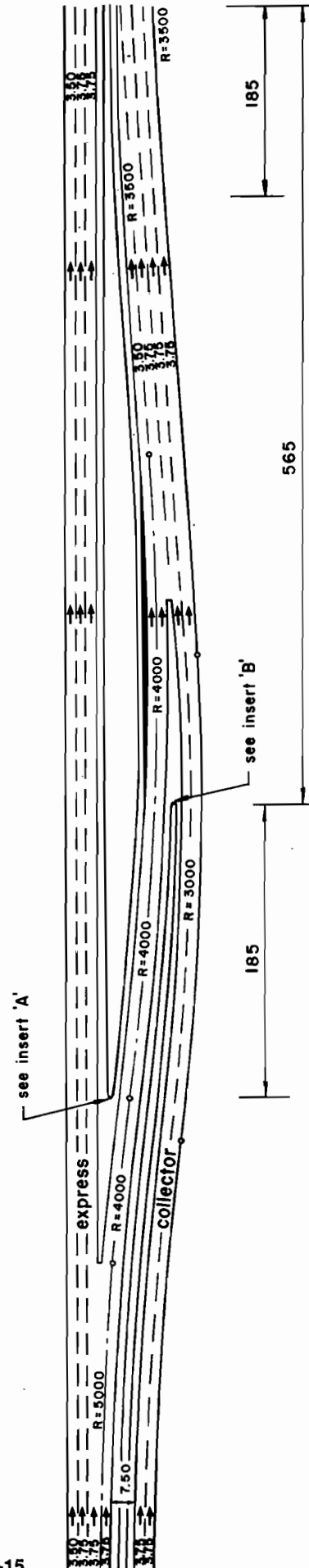
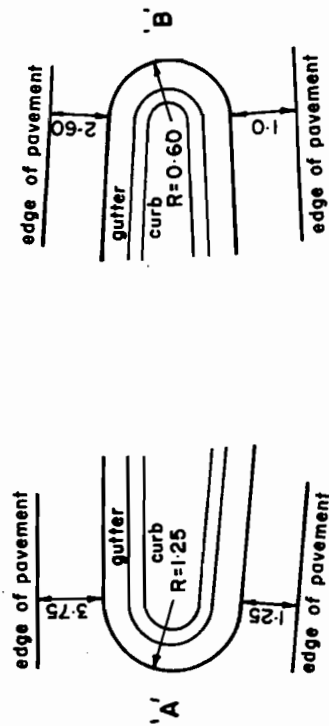

Figure FA-15
Transfer Roadway; Express to Collector Lanes